



# OIML BULLETIN

VOLUME LVI • NUMBER 2

APRIL 2015

*Quarterly Journal*

*Organisation Internationale de Métrologie Légale*



World Metrology Day 2015:  
Measurements and Light



## BULLETIN

VOLUME LVI • NUMBER 2

APRIL 2015

THE OIML BULLETIN IS THE  
QUARTERLY JOURNAL OF THE  
ORGANISATION INTERNATIONALE  
DE MÉTROLOGIE LÉGALE

The Organisation Internationale de Métrologie Légale (OIML), established 12 October 1955, is an inter-governmental organization whose principal aim is to harmonize the regulations and metrological controls applied by the national metrology services of its Members.

**EDITOR-IN-CHIEF:** Stephen Patoray  
**EDITOR:** Chris Pulham

**THE ONLINE BULLETIN IS FREE OF CHARGE**

ISSN 0473-2812

PRINTED IN FRANCE

JOSÉ MOYARD IMPRIMEUR  
8 RUE ROBERT SCHUMAN  
10300 SAINTE SAVINE

### OIML PRESIDUM AND PRESIDENTIAL COUNCIL

#### PRESIDENT

Peter Mason (UNITED KINGDOM)

#### VICE-PRESIDENTS

Roman Schwartz (GERMANY)  
YUKINOBU MIKI (JAPAN)

#### MEMBERS (IN ALPHABETICAL ORDER)

Pu Changcheng (P.R. CHINA)  
Charles D. Ehrlich (UNITED STATES)  
Alan E. Johnston (CANADA)  
Corinne Lagauterie (FRANCE)  
Cees van Mullem (NETHERLANDS)  
Valérie Villière (AUSTRALIA)

Stephen Patoray (DIRECTOR OF BIML)

### OIML SECRETARIAT

#### BUREAU INTERNATIONAL DE MÉTROLOGIE LÉGALE (BIML)

11 RUE TURGOT - 75009 PARIS - FRANCE

TEL: 33 (0)1 4878 1282

FAX: 33 (0)1 4282 1727

INTERNET: [www.oiml.org](http://www.oiml.org) or [www.oiml.int](http://www.oiml.int)  
[www.metrologyinfo.org](http://www.metrologyinfo.org)

### BIML STAFF

#### DIRECTOR

Stephen Patoray ([stephen.patoray@oiml.org](mailto:stephen.patoray@oiml.org))

#### ASSISTANT DIRECTORS

Ian Dunmill ([ian.dunmill@oiml.org](mailto:ian.dunmill@oiml.org))

Willem Kool ([willem.kool@oiml.org](mailto:willem.kool@oiml.org))

#### STAFF MEMBERS (IN ALPHABETICAL ORDER)

Jalil Adnani: Database Systems Management  
([jalil.adnani@oiml.org](mailto:jalil.adnani@oiml.org))

Jean-Christophe Esmiol: IT Systems Management  
([jean-christophe.esmiol@oiml.org](mailto:jean-christophe.esmiol@oiml.org))

Florence Martinie: Administrator, Finance  
([florence.martinie@oiml.org](mailto:florence.martinie@oiml.org))

Luis Mussio: Engineer  
([luis.mussio@oiml.org](mailto:luis.mussio@oiml.org))

Chris Pulham: Editor/Webmaster  
([chris.pulham@oiml.org](mailto:chris.pulham@oiml.org))

Patricia Saint-Germain: Administrator, Members  
([patricia.saint-germain@oiml.org](mailto:patricia.saint-germain@oiml.org))

## OIML MEMBER STATES

ALBANIA	KAZAKHSTAN
ALGERIA	KENYA
AUSTRALIA	REP. OF KOREA
AUSTRIA	MACEDONIA, THE FORMER YUGOSLAV REPUBLIC OF
BELARUS	MONACO
BELGIUM	MOROCCO
BRAZIL	NETHERLANDS
BULGARIA	NEW ZEALAND
CAMEROON	NORWAY
CANADA	PAKISTAN
P.R. CHINA	POLAND
COLOMBIA	PORTUGAL
CROATIA	ROMANIA
CUBA	RUSSIAN FEDERATION
CYPRUS	SAUDI ARABIA
CZECH REPUBLIC	SERBIA
DENMARK	SLOVAKIA
EGYPT	SLOVENIA
FINLAND	SOUTH AFRICA
FRANCE	SPAIN
GERMANY	SRI LANKA
GREECE	SWEDEN
HUNGARY	SWITZERLAND
INDIA	TANZANIA
INDONESIA	TUNISIA
ISLAMIC REPUBLIC OF IRAN	TURKEY
IRELAND	UNITED KINGDOM
ISRAEL	UNITED STATES OF AMERICA
ITALY	VIETNAM
JAPAN	ZAMBIA

## OIML CORRESPONDING MEMBERS

ARGENTINA	MALTA
AZERBAIJAN	MAURITANIA
BAHRAIN	MAURITIUS
BANGLADESH	MEXICO
BARBADOS	MOLDOVA
BENIN	MONGOLIA
BOSNIA AND HERZEGOVINA	MONTENEGRO
BOTSWANA	MOZAMBIQUE
CAMBODIA	NAMIBIA
COSTA RICA	NEPAL
DOMINICAN REPUBLIC	NIGERIA
ESTONIA	OMAN
FIJI	PANAMA
GABON	PAPUA NEW GUINEA
GAMBIA	PARAGUAY
GEORGIA	PERU
GHANA	QATAR
GUATEMALA	RWANDA
GUINEA	SEYCHELLES
HONG KONG, CHINA	SIERRA LEONE
ICELAND	SINGAPORE
IRAQ	SUDAN
JORDAN	SYRIA
DPR KOREA	CHINESE TAIPEI
KUWAIT	THAILAND
KYRGYZSTAN	TRINIDAD AND TOBAGO
LATVIA	UEMOA
LIBERIA	UGANDA
LIBYA	UKRAINE
LITHUANIA	UNITED ARAB EMIRATES
LUXEMBURG	URUGUAY
MADAGASCAR	UZBEKISTAN
MALAWI	YEMEN
MALAYSIA	ZIMBABWE

### ■ technique

---

- 5 Monte Carlo simulations of the susceptometer method  
**Frank Scholz**
- 13 A simple method for the in-field control of standard capacity measures used by licensed verifiers of fuel dispensing devices  
**Giuseppe Ardimento**
- 17 Metrological confirmation of volume measuring systems installed at PETROBRAS' fuel road tanker loading terminals  
**Christian Raffaello Baldo and Érico Vieira Porto**

### ■ update

---

- 24 List of OIML Issuing Authorities
- 25 OIML Systems: Basic and MAA Certificates registered by the BIML, 2014.12–2015.02
- 33 World Metrology Day 2015: Measurements and Light
- 36 Legal metrology well prepared for the ASEAN Economic Community - **Manfred Kochsiek**
- 39 Seventh OIML Award for Excellent Contributions from Developing Countries to Legal Metrology
- 40 New Member, Committee Draft received by the BIML, Calendar of OIML meetings

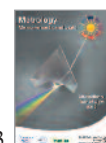

### ■ technique

---

- 5 Simulations Monte Carlo de la méthode susceptomètre  
**Frank Scholz**
- 13 Méthode simple pour le contrôle sur site des mesures de capacité étalons utilisées par des vérificateurs habilités d'appareils de distribution de carburant  
**Giuseppe Ardimento**
- 17 Confirmation métrologique des systèmes de mesure de volume installés aux terminaux de chargement des camions citernes chez PETROBRAS  
**Christian Raffaello Baldo et Érico Vieira Porto**

### ■ update

---

- 24 Liste des Autorités de Délivrance OIML
- 25 Systèmes OIML: Certificats de Base et MAA enregistrés par le BIML, 2014.12–2015.02
- 33 Journée Mondiale de la Métrologie 2015: Mesures et lumière
- 36 La métrologie légale bien préparée pour la Communauté Economique ASEAN - **Manfred Kochsiek**
- 39 Septième Récompense OIML pour les contributions d'excellence de la part de pays en développement envers la métrologie légale
- 40 Nouveau Membre, Projet de Comité reçu par le BIML, Agenda des réunions OIML

# ■ Editorial



STEPHEN PATORAY  
BIML DIRECTOR

## OIML Website

I was very encouraged as I read President Mason's Editorial in the January edition of the Bulletin. Peter did an excellent job in summing up the recent developments which will continue to improve the way in which the OIML carries out its work. Since the initial implementation of the OIML website, which focused mainly on CIML Members and Corresponding Member Representatives, we have seen a continuing interest in the site. We have received many constructive and helpful suggestions to enable us to improve how the site operates. We are also very encouraged with the positive feedback received from the actual users of the site and how it is helping them to improve the work they do for the Organization.

Recently, as President Mason alluded to in his Editorial, we have introduced a newly designed Project Groups Workspace. This PG Workspace takes all of the features of the older version, the "Plone Workgroups" site, and builds on them with a set of more intuitive and significantly enhanced features. It provides the conveners with the necessary tools to more easily upload and share all types of documents and correspondence, conduct inquiries, and organize meetings. It allows conveners, as well as all the members of each Project Group, to readily access all the documents that have been posted. When requested, contacts are also able to upload comments which are immediately visible to all members of the Project Group. There will thus be a permanent record of the progress being made on each project.

In addition, we have begun work on a number of additional website tools which will be added in due course.

These will include

- improved registration for the 50th CIML Meeting,
- online request for review of OIML publications by the TC or TC/SC,
- workspace for the Presidential Council,
- online request for the re-election of the secretariats and the convenerships,
- workspace for the MAA Ad Hoc working group,
- workspace for the MAA/CPR, and
- other workspaces which will also be developed as needed.

With these as well as numerous other improvements, there is now the need to take a very close look at the way in which OIML publications are developed. The BIML, together with President Mason and a small task group, is now reviewing "best practices" in the development of international standards. We are in consultation with ISO and other international standards development organizations to determine how we can best take advantage of their experience in developing literally thousands of standards each year. The CIML can look forward to a proposal for a new project for a revision of B 6 at the 50th CIML Meeting.

We encourage all users of the OIML website to continue to provide feedback, which is always taken into consideration and which we value greatly as it helps us to shape the future of your website. We look forward to continuing to work with you on this very exciting enhancement to the work of the OIML. ■



## MONTE CARLO METHOD

# Monte Carlo simulations of the susceptometer method

FRANK SCHOLZ  
 Physikalisch-Technische Bundesanstalt (PTB),  
 Braunschweig

## 1 Introduction

Magnetic interactions between weights and magnetic fields originating from outside or inside a balance may influence the results of high-precision mass determinations leading to systematic or non-systematic weighing errors [1, 2]. For this reason, upper limits for the volume magnetic susceptibility and the permanent magnetic polarization of a weight are laid down in OIML R 111 [3]. Within those limits the magnetic forces exerted on the weight cause an apparent change of the conventional mass of less than 10 % of the maximum permissible error [1, 3]. Consequently, the uncertainty components due to the magnetism of the weight are negligibly small if its volume magnetic susceptibility  $\chi$  and permanent magnetic polarization  $p_z$  are lower than the specified maximum values given in Tables 1 and 2 [3].

Table 1: Upper limits of the volume magnetic susceptibility  $\chi$  recommended for the weight classes  $E_1$  to  $F_2$  depending on the nominal value  $m$  of the test weight [3]

	$E_1$	$E_2$	$F_1$	$F_2$
$m \leq 1 \text{ g}$	0.25	0.9	10	-
$2 \text{ g} \leq m \leq 10 \text{ g}$	0.06	0.18	0.7	4
$20 \text{ g} \leq m$	0.02	0.07	0.2	0.8

Table 2: Maximum absolute values of the permanent magnetic polarization  $p_z$  in  $\mu\text{T}$  recommended for the weight classes  $E_1$  to  $M_3$  [3]

$E_1$	$E_2$	$F_1$	$F_2$	$M_1$	$M_{1-2}$	$M_2$	$M_{2-3}$	$M_3$
2.5	8	25	80	250	500	800	1600	2500

OIML R 111 [3] recommends, *inter alia*, the so-called susceptometer developed by Davis [4, 5] for determining the magnetic properties of weights with volume magnetic susceptibilities  $\chi < 1$  and nominal values between 2 g and 50 kg. However, up to now the uncertainties resulting from the susceptometer method have been calculated only for a special comparison measurement technique [6, 7] or evaluated with the help of extensive error tables [8]. In this paper we will present a more general uncertainty analysis in accordance with the "Guide to the expression of uncertainty in measurement" (GUM) [9] using Monte Carlo simulations [10].

## 2 Experimental setup

The schematic experimental setup of a susceptometer is shown in Figure 1 [3-5]. On the load receptor (E) of a high-resolution balance (F) a small cylindrical SmCo or NdFeB permanent magnet (C) rests on a tubular pedestal (D) made of non-magnetic material. A non-magnetic bridge (B) spans the magnet and the weighing instrument. The vertical spacing  $Z_0$  between the middle of the permanent magnet and the upper side of the span can be changed by using suitable gauge blocks (G) under each column of the bridge.

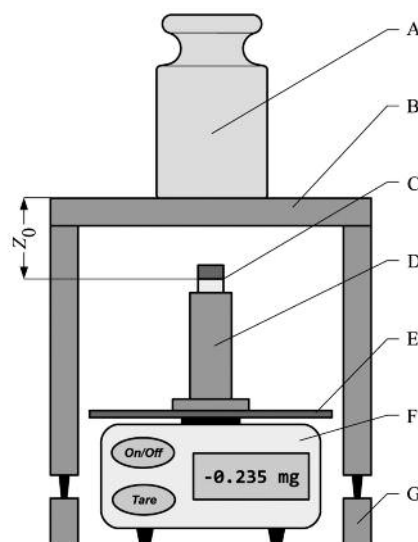

Figure 1: Schematic experimental setup of a susceptometer according to Davis [3-5]

The north pole of the permanent magnet points downwards, the balance is tared and the weight under test (A) is positioned on top of the span centrally above the magnet. Due to the magnetic interactions between the weight and the permanent magnet, a force is exerted

on the magnet causing a small balance indication  $m_1$ . The weight is removed from the bridge, the permanent magnet is turned upside down (north pole upwards), the balance is tared again and the weight is repositioned on the bridge leading to a second balance indication  $m_2$ . Usually  $m_1$  and  $m_2$  are smaller than zero due to the attraction forces between the permanent magnet and the test object.

Special care has to be taken in order to ensure that the weight under investigation is not permanently magnetized during the measurements. Therefore, the maximum magnetic field strength at the top of the span should not exceed  $2000 \text{ A m}^{-1}$ ,  $800 \text{ A m}^{-1}$  and  $200 \text{ A m}^{-1}$  when testing weights of class E<sub>1</sub>, E<sub>2</sub> and of all other classes, respectively [3]. If a permanent magnet with a magnetic moment of typically  $M_d = 0.1 \text{ A m}^2$  is used, the maximum magnetic field strengths correspond to vertical spacings  $Z_0$  of 20.0 mm, 27.1 mm and 43.1 mm [3-5]. These distance levels should be fallen below only if the balance indications  $m_1$  and  $m_2$  are too weak [3].

### 3 Model equations

The volume magnetic susceptibility  $\chi$  and the (vertical component of the) permanent magnetic polarization  $p_z$  of the weight are calculated as follows [3-5, 11]:

$$\chi = - \frac{(m_1 + m_2) \cdot g}{I_a \cdot \frac{3\mu_0 M_d^2}{32\pi Z_0^4} + 0.4 (m_1 + m_2) \cdot g} \quad (1)$$

and

$$p_z = - \frac{2\pi Z_0 \cdot (m_1 - m_2) \cdot g}{I_b \cdot M_d} - \frac{\chi B_{EZ}}{1 + 0.23 \chi} \quad (2)$$

Here  $m_1$  and  $m_2$  are the balance indications with the north pole of the magnet pointing downwards and upwards, respectively,  $g$  is the gravitational acceleration at the place of measurement,  $M_d$  is the magnetic moment of the permanent magnet,  $Z_0$  is the vertical distance between the mid-height of the magnet and the upper side of the span,  $B_{EZ}$  is the vertical component of the magnetic induction in the environment of the susceptometer and  $\mu_0 = 4\pi \cdot 10^{-7} \text{ N A}^{-2}$  is the magnetic constant.

### 4 Geometrical approximation of weights

The geometrical correction factors  $I_a$  and  $I_b$  used in equations (1) and (2) consider the magnetically sensitive volume of the test weight and can be computed by numerical integration [4, 5] or by the superposition of a number of cone frustums [8, 12]. However, in the following  $I_a$  and  $I_b$  are estimated by approximating the external shape of a weight with the signed superposition of  $N$  cylinders with  $P$  different diameters  $D_1, \dots, D_P$  ( $P \leq N$ ) and  $Q$  different heights  $H_1, \dots, H_Q$  ( $Q \leq N$ ) as is often done in practice and was originally proposed by Davis [4, 5]:

$$I_a = \sum_{i=1}^N \xi_{a,i} \quad (3)$$

and

$$I_b = \sum_{i=1}^N \psi_{b,i} \quad (4)$$

The geometry factors  $\xi_{a,i}$  and  $\psi_{b,i}$  of the  $i$ -th single cylinder ( $i = 1, \dots, N$ ) with diameter  $\delta_i \in \{D_1, \dots, D_P\}$  and height  $\eta_i \in \{H_1, \dots, H_Q\}$  are given by [3-5, 11]:

$$\xi_{a,i} = (-1)^{\alpha_i} \cdot \left( 1 - \frac{1 + \frac{1}{12} \left(\frac{\delta_i}{Z_0}\right)^2}{\left[1 + \frac{1}{4} \left(\frac{\delta_i}{Z_0}\right)^2\right]^3} - \left(\frac{Z_0}{Z_0 + \eta_i}\right)^4 \right) \cdot \left( 1 - \frac{1 + \frac{1}{12} \left(\frac{\delta_i}{Z_0 + \eta_i}\right)^2}{\left[1 + \frac{1}{4} \left(\frac{\delta_i}{Z_0 + \eta_i}\right)^2\right]^3} \right) \quad (5)$$

and

$$\psi_{b,i} = \frac{\pi}{2} \cdot (-1)^{\alpha_i} \cdot \left\{ \frac{\left(\frac{\delta_i}{Z_0}\right)^2}{\left[1 + \frac{1}{4} \left(\frac{\delta_i}{Z_0}\right)^2\right]^{\frac{3}{2}}} - \frac{Z_0}{Z_0 + \eta_i} \right. \\ \left. \cdot \frac{\left(\frac{\delta_i}{Z_0 + \eta_i}\right)^2}{\left[1 + \frac{1}{4} \left(\frac{\delta_i}{Z_0 + \eta_i}\right)^2\right]^{\frac{3}{2}}} \right\} \quad (6)$$

Hereby, the term  $(-1)^{\alpha_i}$ , where  $\alpha_i = 1$  or  $\alpha_i = 2$  is always valid, indicates the sign of the  $i$ -th cylinder within the approximation.



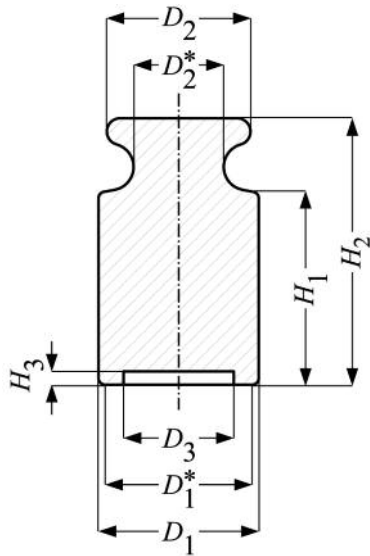

Figure 2: Schematic cross section of a cylindrical weight with a recessed base according to OIML R 111 [3]

As an example Figure 2 shows the schematic cross section of a cylindrical weight with a recessed base according to OIML R 111 [3]. The most characteristic dimensions are the diameter  $D_1$  and the height  $H_1$  of the cylindrical weight body, the diameter  $D_1^*$  of the cylindrical part without rounded edges, the diameter  $D_2$  of the knob, the diameter  $D_2^*$  of the weight's neck, the total height  $H_2$  and the diameter  $D_3$  and the depth  $H_3$  of the cylindrical recess.

Figure 3 and Figure 4 illustrate how the external shape of such an OIML weight in an upright position (which is the usual experimental orientation) can be approximated by the signed superposition of the so-called "outer" and "inner" cylinders as proposed by Davis [5]. The approximation with the outer cylinders (see Figure 3) yields an upper limit for the geometrical correction factors  $I_a$  and  $I_b$  and ensures that the entire weight is contained by the final superposition. On the other hand, the approximation with the inner cylinders (see Figure 4) leads to an underestimation of  $I_a$  and  $I_b$  and to a superposition that is completely covered up by the test weight. It is important to note that the base area of each single cylinder must always coincide with the top of the span independent of the concrete approximation method [5]. In order to create a better overview,

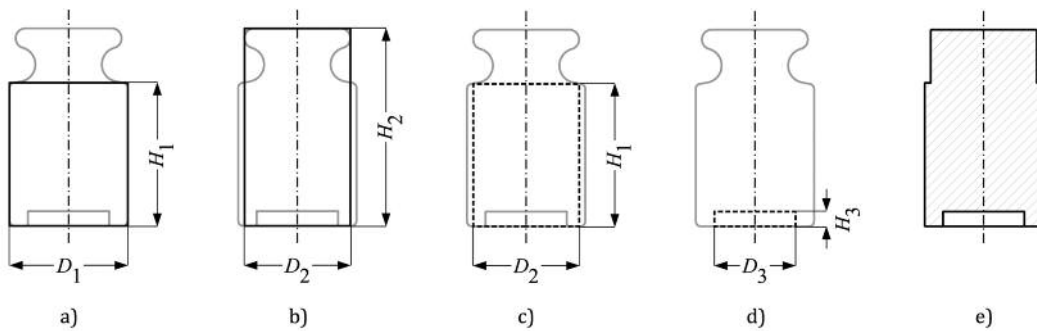

Figure 3: Illustration of the geometrical approximation of an OIML weight in an upright position with "outer" cylinders. a) – d) single cylinders used for the superposition, whereby the dashed cylinders c) and d) have a negative sign; e) schematic cross section of the external shape of an OIML weight after the approximation with outer cylinders [5]

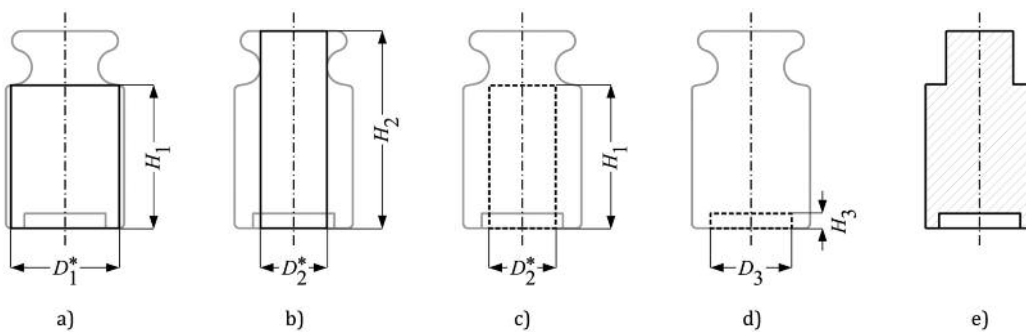

Figure 4: Illustration of the geometrical approximation of an OIML weight in an upright position with "inner" cylinders. a) – d) single cylinders used for the superposition, whereby the dashed cylinders c) and d) have a negative sign; e) schematic cross section of the external shape of an OIML weight after the approximation with inner cylinders [5]

Table 3: Diameters, heights and signs of single cylinders used for the approximation of the external shape of an OIML weight in an upright position (see Figures 3 and 4)

cylinder no. $i$	diameter		height $\eta_i$	sign	$\alpha_i$
	$\delta_i$				
	outer cylinders	inner cylinders			
1	$D_1$	$D_1^*$	$H_1$	+	2
2	$D_2$	$D_2^*$	$H_2$	+	2
3	$D_2$	$D_2^*$	$H_1$	-	1
4	$D_3$	$D_3$	$H_3$	-	1

Table 3 lists the diameters, heights and signs of the single cylinders used for the corresponding superposition.

In summary, the external shape of a cylindrical OIML weight is approximated by the signed superposition of in total  $N = 4$  cylinders with  $P = 3$  different diameters and  $Q = 3$  different heights. The difference between the two approximation methods results from the formation of the first three cylinders: for the approximation with outer cylinders the diameters  $D_1$  and  $D_2$  are used, while the inner cylinders are calculated with the diameters  $D_1^*$  and  $D_2^*$  (see Figure 3, Figure 4 and Table 3). The approximation of weights with a flat bottom is straightforward, since in this case  $D_3 = H_3 = 0$  holds and  $\xi_{a,4}$  and  $\psi_{b,4} = 0$  is valid (see Equations (5) and (6)).

It must be emphasized that the geometrical approximation can be much more extensive than shown here, e.g. if the number  $N$  of single cylinders used is increased, if the weight is turned upside down or for weights with adjusting cavities [3, 5, 7, 8]. Yet this neither changes the principle of the uncertainty evaluation presented in the following nor is it necessary in most cases. Because of a lack of space, however, only weights with a recessed base in an upright position consisting of a single piece of material will be considered throughout this paper.

## 5 The vertical distance $Z_0$

Sophisticated procedures for the evaluation of the magnetic moment  $M_d$  and the vertical spacing  $Z_0$  can be found in the literature [5, 7]. At the PTB, however, we use a calibrated permanent magnet, while the determination of  $Z_0$  is based on the following submodel:

$$Z_0 = Z_0^{\min} + Z_B \quad (7)$$

Here  $Z_B$  is the height of the gauge blocks being used during the measurements (see Figure 1) and  $Z_0^{\min}$  is the distance between the mid-height of the magnet and the

upper side of the span when no gauge blocks are in operation. Note that  $Z_0^{\min}$  should not be smaller than approx. 15 mm, so that the spherical approximation of the cylindrical permanent magnet still holds [5].

For the evaluation of the vertical spacing  $Z_0^{\min}$  all gauge blocks are removed, a cylindrical susceptibility standard with known volume magnetic susceptibility  $\chi^S$  is placed on the span and the balance indications  $m_1^S$  and  $m_2^S$  are recorded as described in section 2. The distance  $Z_0^{\min}$  is then calculated from the following equation which was derived from equation (1):

$$Z_0^{\min} = \left[ -\frac{3\mu_0 \cdot M_d^2 \cdot I_a^S}{32\pi \cdot (m_1^S + m_2^S) \cdot g \cdot \left(0.4 + \frac{1}{\chi^S}\right)} \right]^{\frac{1}{4}} \quad (8)$$

However, the geometrical correction factor  $I_a^S$  of the cylindrical susceptibility standard depends on its diameter  $D^S$  and height  $H^S$  as well as on the spacing  $Z_0^{\min}$  (see Equations (3) and (5)), so that Equation (8) cannot be written in a closed form. For this reason, Equation (8) is solved using an iteration algorithm already described by Davis [5].

## 6 Monte Carlo simulations

In summary, the volume magnetic susceptibility  $\chi$  is calculated from a total of 24 input quantities  $X_1, \dots, X_{24}$ , namely the balance indications  $m_1$  and  $m_2$ , the gravitational acceleration  $g$ , the magnetic moment  $M_d$  of the permanent magnet, the height  $Z_B$  of the gauge blocks, the balance indications  $m_1^S$  and  $m_2^S$  evaluated from the measurements with the susceptibility standard, the diameter  $D^S$  and the height  $H^S$  of the susceptibility standard, the volume magnetic susceptibility  $\chi^S$  of the susceptibility standard, the diameters  $D_1, \dots, D_3$  and the heights  $H_1, \dots, H_3$  of the four cylinders used for the geometrical approximation of the test weight (see Equations (1), (3), (5), (7) and (8)). For the computation of the permanent magnetic polarization  $P_z$ , an extra input quantity  $X_{25}$  (that is the vertical component of the permanent induction  $B_{EZ}$  in the environment of the susceptometer) is needed (see Equations (2), (4) and (6), (7) and (8)). Please note that for all geometric measures two input quantities are used: one considers the statistical part (determined from repeated observations of a calibrated vernier caliper) and the other one takes the systematic errors of the caliper into account. For simplicity purposes, the uncertainty components due to the resolution of a measuring device are assumed to be negligibly small in all cases.

Based on susceptometer measurements of a 2 g OIML weight in an upright position, Table 4 lists the

Table 4: Best estimates, associated standard uncertainties and probability distribution functions (PDFs) assigned to the input quantities. The index “stat” specifies the statistical part of an input quantity, which was determined from repeated observations. The index “syst” on the other hand considers the systematic errors of that input. For the meaning of the abbreviations in the last column, refer to [10]

$X_\beta$	$x_\beta$	$u(x_\beta)$	PDF
$m_1$	-0.05530 mg	0.00087 mg	$t_v(\bar{x}, s_p^2/n)$
$m_2$	-0.04300 mg	0.00087 mg	$t_v(\bar{x}, s_p^2/n)$
$g$	9.8100 m s <sup>-2</sup>	0.0058 m s <sup>-2</sup>	R(a, b)
$M_d$	0.08969 A m <sup>2</sup>	0.00023 A m <sup>2</sup>	N(x, u <sup>2</sup> (x))
$B_{EZ}$	36.9 μT	1.1 μT	R(a, b)
$Z_B$	0 mm	0 mm	R(a, b)
$m_1^S$	-0.51030 mg	0.00087 mg	$t_v(\bar{x}, s_p^2/n)$
$m_2^S$	-0.47970 mg	0.00087 mg	$t_v(\bar{x}, s_p^2/n)$
$\chi^S$	0.003967	0.000028	T(a, b)
$D_{stat}^S$	48.140 mm	0.020 mm	$t_v(\bar{x}, s_p^2/n)$
$D_{syst}^S$	0.000 mm	0.017 mm	N(x, u <sup>2</sup> (x))
$H_{stat}^S$	71.010 mm	0.020 mm	$t_v(\bar{x}, s_p^2/n)$
$H_{syst}^S$	0.000 mm	0.017 mm	N(x, u <sup>2</sup> (x))
$H_{1,stat}$	8.272 mm	0.020 mm	$t_v(\bar{x}, s_p^2/n)$
$H_{1,syst}$	0.000 mm	0.017 mm	N(x, u <sup>2</sup> (x))
$H_{2,stat}$	11.062 mm	0.020 mm	$t_v(\bar{x}, s_p^2/n)$
$H_{2,syst}$	0.000 mm	0.017 mm	N(x, u <sup>2</sup> (x))
$H_{3,stat}$	0.146 mm	0.025 mm	$t_{n-1}(\bar{x}, s^2/n)$
$H_{3,syst}$	0.000 mm	0.017 mm	N(x, u <sup>2</sup> (x))
<i>outer cylinders</i>			
$D_{1,stat}$	5.790 mm	0.020 mm	$t_v(\bar{x}, s_p^2/n)$
$D_{1,syst}$	0.000 mm	0.017 mm	N(x, u <sup>2</sup> (x))
$D_{2,stat}$	5.272 mm	0.020 mm	$t_v(\bar{x}, s_p^2/n)$
$D_{2,syst}$	0.000 mm	0.017 mm	N(x, u <sup>2</sup> (x))
$D_{3,stat}$	4.064 mm	0.076 mm	$t_{n-1}(\bar{x}, s^2/n)$
$D_{3,syst}$	0.000 mm	0.017 mm	N(x, u <sup>2</sup> (x))
<i>inner cylinders</i>			
$D_{1,stat}^*$	4.750 mm	0.020 mm	$t_v(\bar{x}, s_p^2/n)$
$D_{1,syst}^*$	0.000 mm	0.017 mm	N(x, u <sup>2</sup> (x))
$D_{2,stat}^*$	2.906 mm	0.020 mm	$t_v(\bar{x}, s_p^2/n)$
$D_{2,syst}^*$	0.000 mm	0.017 mm	N(x, u <sup>2</sup> (x))
$D_{3,stat}^*$	4.064 mm	0.076 mm	$t_{n-1}(\bar{x}, s^2/n)$
$D_{3,syst}^*$	0.000 mm	0.017 mm	N(x, u <sup>2</sup> (x))

best estimates  $X_1, \dots, X_{25}$ , the associated standard uncertainties  $u(x_1), \dots, u(x_{25})$  and the probability distribution functions (PDFs) assigned to the input quantities  $X_1, \dots, X_{25}$ . With these data, adaptive Monte Carlo simulations according to the GUM [10] were performed using Microsoft Excel. The correlations between the systematic components of the geometric measures were considered by means of a multivariate Gaussian distribution [10].

Figure 5 shows the scaled frequency distribution of the vertical spacing  $Z_0^{\min}$  obtained from 10<sup>5</sup> trials of the Monte Carlo simulation. Hereby, each single sample of  $Z_0^{\min}$  was calculated in accordance with equation (8) following the iteration procedure given by Davis [5]. The Monte Carlo simulation leads to the best estimate  $Z_0^{\min} = 18.350$  mm with an associated standard uncertainty  $u(Z_0^{\min}) = 0.038$  mm (see Table 5). Although the gravitational acceleration  $g$  was estimated rather conservatively (see Table 4), the correlation coefficient  $r(Z_0^{\min}, g)$  between  $Z_0^{\min}$  and  $g$  is negligibly small ( $r(Z_0^{\min}, g) \approx -0.07$ ). On the other hand, the correlation coefficient  $r(Z_0^{\min}, M_d)$  between the magnetic moment  $M_d$  of the permanent magnet and  $Z_0^{\min}$  is  $r(Z_0^{\min}, M_d) \approx 0.57$  and should be taken into account if further samplings are desired.

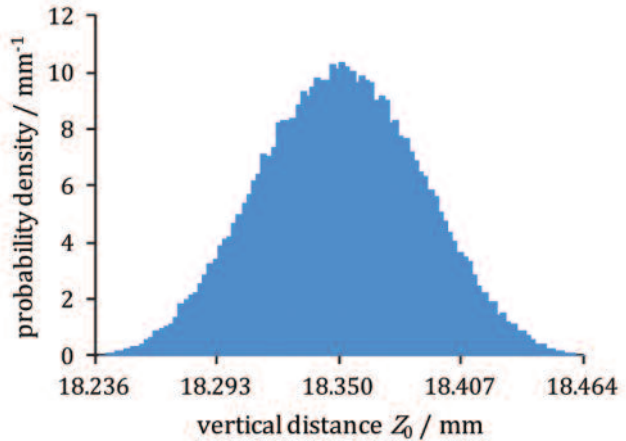

Figure 5: Scaled frequency distribution of the vertical distance  $Z_0^{\min}$

In Figures 6 to 9 scaled frequency histograms of the geometrical correction factors  $I_a$  and  $I_b$  are shown for the approximation with the outer (Figures 6 and 7) and inner cylinders (Figures 8 and 9), respectively. The results are summarized in Table 5.

The scaled frequency distributions of the volume magnetic susceptibility  $\chi$  and the permanent magnetic polarization  $p_Z$  are shown in Figures 10 to 13 for the approximation with the outer (Figures 10 and 11) and

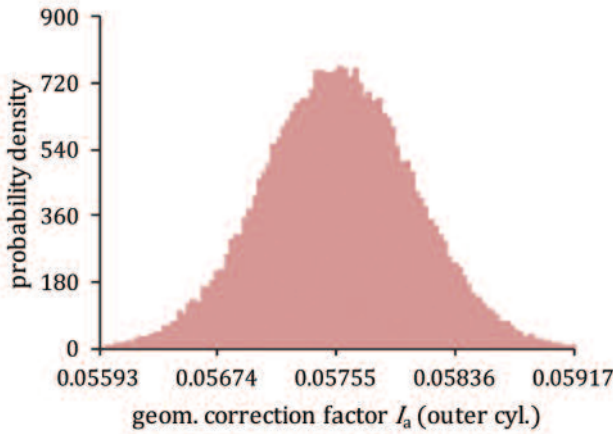

Figure 6: Scaled frequency distribution of the geometrical approximation factor  $I_a$  after the approximation with the outer cylinders

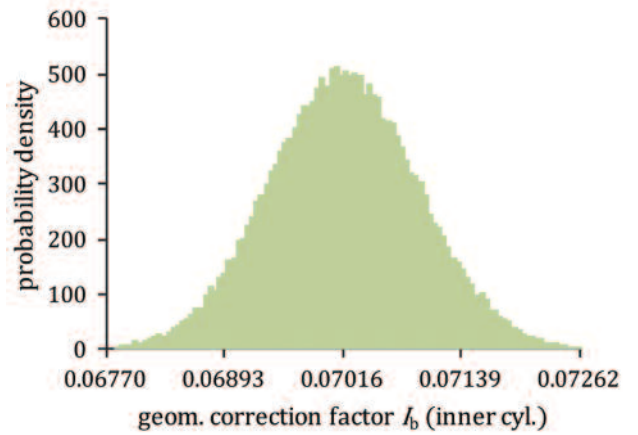

Figure 9: Scaled frequency distribution of the geometrical approximation factor  $I_b$  after the approximation with the inner cylinders

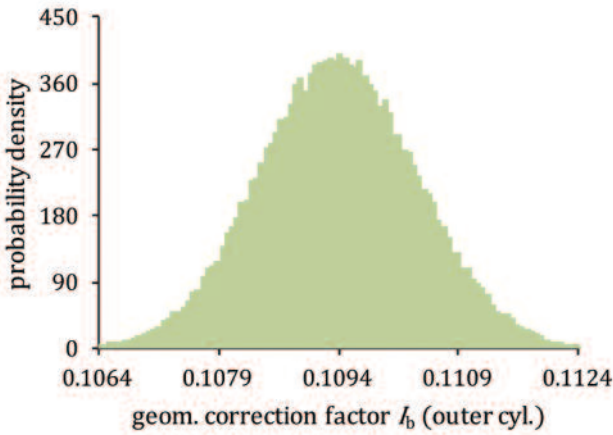

Figure 7: Scaled frequency distribution of the geometrical approximation factor  $I_b$  after the approximation with the outer cylinders

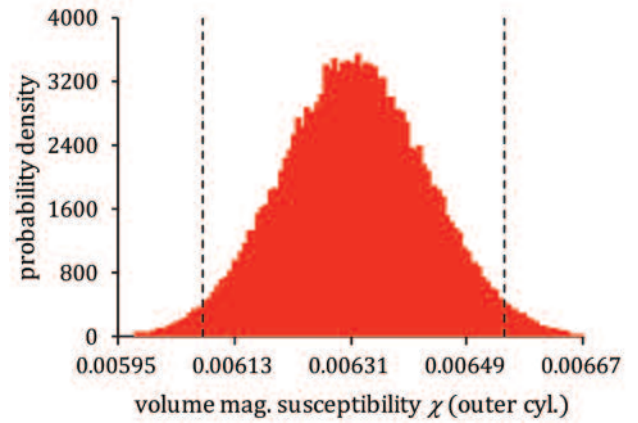

Figure 10: Scaled frequency distribution of the volume magnetic susceptibility  $\chi$  after the approximation with the outer cylinders. The dashed vertical lines give the endpoints of the probabilistically symmetric 95.45 % coverage interval [10]

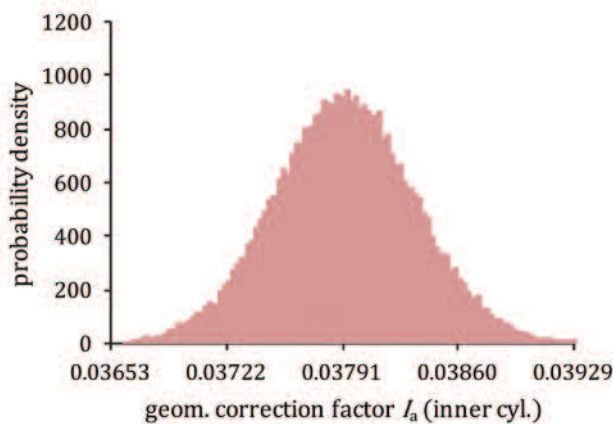

Figure 8: Scaled frequency distribution of the geometrical approximation factor  $I_a$  after the approximation with the inner cylinders

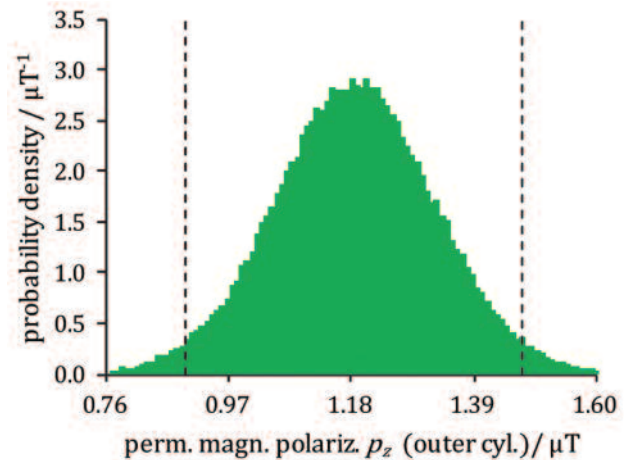

Figure 11: Scaled frequency distribution of the permanent magnetic polarization  $p_z$  after the approximation with the outer cylinders. The dashed vertical lines give the endpoints of the probabilistically symmetric 95.45 % coverage interval [10]

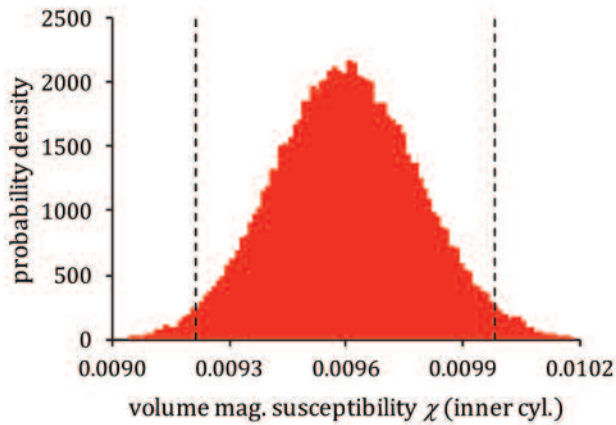

Figure 12: Scaled frequency distribution of the volume magnetic susceptibility  $\chi$  after the approximation with the inner cylinders. The dashed vertical lines give the endpoints of the probabilistically symmetric 95.45 % coverage interval [10]

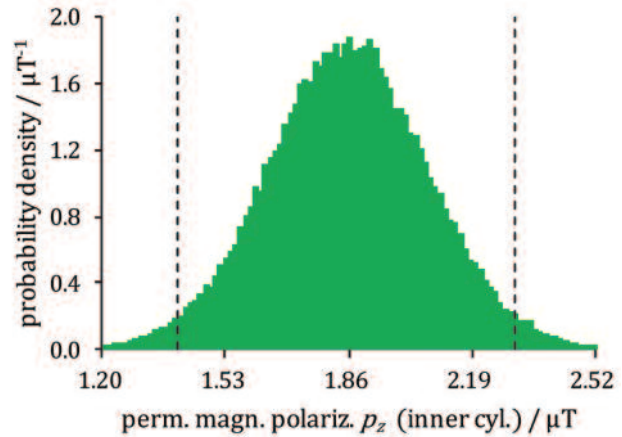

Figure 13: Scaled frequency distribution of the permanent magnetic polarization  $p_z$  after the approximation with the inner cylinders. The dashed vertical lines give the endpoints of the probabilistically symmetric 95.45 % coverage interval [10]

Table 5: Comparison of the results obtained from the Monte Carlo method (MCM) and the GUM uncertainty framework (GUF) [11, 13]

Method	Output quantity	Best estimate	Standard uncertainty	Probabilistically symmetric 95.45 % coverage interval
MCM	$Z_0^{\min}$	18.350 mm	0.038 mm	[18.274 mm , 18.426 mm]
<i>outer cylinders</i>				
MCM	$I_a$	0.05755	0.00054	[0.05648 , 0.05864]
MCM	$I_b$	0.1094	0.0010	[0.1073 , 0.1114]
MCM	$\chi$	0.00631	0.00012	[0.00608 , 0.00655]
GUF	$\chi$	0.00631	0.00011	[0.00609 , 0.00653]
MCM	$p_z$	1.18 $\mu\text{T}$	0.14 $\mu\text{T}$	[0.90 $\mu\text{T}$ , 1.47 $\mu\text{T}$ ]
GUF	$p_z$	1.19 $\mu\text{T}$	0.13 $\mu\text{T}$	[0.92 $\mu\text{T}$ , 1.46 $\mu\text{T}$ ]
<i>inner cylinders</i>				
MCM	$I_a$	0.03791	0.00045	[0.03701 , 0.03882]
MCM	$I_b$	0.07016	0.00081	[0.06854 , 0.07179]
MCM	$\chi$	0.00960	0.00019	[0.00922 , 0.00999]
GUF	$\chi$	0.00960	0.00018	[0.00924 , 0.00997]
MCM	$p_z$	1.86 $\mu\text{T}$	0.22 $\mu\text{T}$	[1.41 $\mu\text{T}$ , 2.31 $\mu\text{T}$ ]
GUF	$p_z$	1.86 $\mu\text{T}$	0.20 $\mu\text{T}$	[1.44 $\mu\text{T}$ , 2.28 $\mu\text{T}$ ]

inner cylinders (Figures 12 and 13). Hereby, the dashed lines give the endpoints of the probabilistically symmetric 95.45 % coverage interval [10]. The results are summarized in Table 5. The volume magnetic susceptibility and the permanent magnetic polarization of the weight are correlated with a negligibly small correlation coefficient  $r(\chi, p_z) < 0.1$ . Although the geometric approximation with inner cylinders leads to an overestimation of the magnetic properties (especially for weights with lower nominal values), it can be concluded that the magnetic properties of the 2 g OIML weight fulfil the requirements laid down in OIML R 111 [3] for a weight of class E<sub>1</sub> (see Tables 1 and 2).

Finally, the most important results of the Monte Carlo method (MCM) are summarized and compared with the uncertainty determination based on the GUM uncertainty framework (GUF) [9]<sup>1</sup> in Table 5. As can easily be seen, the outcome of the Monte Carlo procedure agrees very well with the “classical” uncertainty analysis according to the GUM [9] within a negligibly small numerical tolerance for the volume  $\chi$  and the permanent magnetic polarization  $p_z$ .

<sup>1</sup> The basic concept of this uncertainty evaluation is described in [11] and a more detailed description will be presented elsewhere [13].

## Summary

The susceptometer developed by Davis is a very suitable instrument for determining the magnetic properties of stainless steel weights. The uncertainties resulting from the susceptometer method were evaluated using Monte Carlo simulations. Hereby, the external shape of the test object was approximated with outer and inner cylinders, respectively. The results obtained from the Monte Carlo simulations agree very well with the uncertainty analysis based on the classical GUM uncertainty framework. ■

## References

- [1] Gläser, M.: *Magnetic interactions between weights and weighing instruments*. Meas. Sci. Technol. **12** (2001), pp. 709-715
- [2] Davis, R.; Gläser, M.: *Magnetic properties of weights, their measurements and magnetic interactions between weights and balances*. Metrologia **40** (2003) pp. 339-355
- [3] OIML R 111 (2004): *Weights of classes  $E_1$ ,  $E_2$ ,  $F_1$ ,  $F_2$ ,  $M_1$ ,  $M_{1,2}$ ,  $M_2$ ,  $M_{2,3}$ ,  $M_3$ . Part 1: metrological and technical requirements*. Paris: International Organization of Legal Metrology (OIML)
- [4] Davis, R. S.: *New method to measure magnetic susceptibility*. Meas. Sci. Technol. **4** (1993) pp. 141-147
- [5] Davis, R. S.: *Determining the magnetic properties of 1 kg mass standards*. J. Res. Natl. Inst. Stand. Technol. **100** (1995) pp. 209-225; Davis, R. S.: *Erratum: determining the magnetic properties of 1 kg mass standards*. J. Res. Natl. Inst. Stand. Technol. **109** (2004) p. 303
- [6] Chung, J. W.; Ryu K. S.; Davis, R. S.: *Uncertainty analysis of the BIPM susceptometer*. Metrologia **38** (2001) pp. 535-541
- [7] Oblak, M.; Grum, M.: *Improved methods for determining the susceptibility of weights*. Meas. Sci. Technol. **17** (2006) pp. 901-907
- [8] Lietz, S. (2004): *Untersuchungen am Suszeptometer*. Ilmenau: Technical University of Ilmenau
- [9] JCGM (BIPM, IEC, IFCC, ILAC, ISO, IUPAC, IUPAP and OIML) (2008): *Evaluation of the measurement data – Guide to the expression of uncertainty in measurement*. Sèvres: International Bureau of Weights and Measures (BIPM). Published by the OIML as OIML G 1-100:2008
- [10] JCGM (BIPM, IEC, IFCC, ILAC, ISO, IUPAC, IUPAP and OIML) (2008): *Evaluation of the measurement data – Supplement 1 to the “Guide to the expression of uncertainty in measurement” – Propagation of distributions using a Monte Carlo method*. Sèvres: International Bureau of Weights and Measures (BIPM). Published by the OIML as OIML G 1-101:2008
- [11] Scholz, F.; Borys, M. (2006): *PTB-Bericht (PTB-MA-78) Vergleichsmessungen zur Bestimmung der magnetischen Eigenschaften von Masse-normalen mit einem Suszeptometer*. Bremerhaven: Wirtschaftsverlag NW – Verlag für neue Wissenschaft GmbH
- [12] Fröhlich, T.; Fehling, T.; Heydenbluth, D. (2003): *Sartorius susceptometer for precise measurement of susceptibility and magnetization of weights*. South Yorkshire Int. Weighing Conf.
- [13] In preparation

## CAPACITY MEASURES

# A simple method for the in-field control of standard capacity measures used by licensed verifiers of fuel dispensing devices

GIUSEPPE ARDIMENTO, Deputy Director  
Market Regulatory Service and Consumers Affairs  
Camera di Commercio di Napoli, Italy

### Introduction

In Italy, both subsequent verification after repair and periodic verification may be performed by accredited verifiers who obtain a licence from the Local Metrology Authority (Camera di Commercio) [1,2] which has jurisdiction over the location at which the verifier has its own premises.

One of the major concerns about the verification activity performed by accredited laboratories is metrological confirmation. Usually 20 L, 50 L and 100 L capacity measures are used as standards in the verification process, but often these standards (especially the 20 L capacity measures) suffer from bad handling and moving practices.

It is therefore necessary, in order to ensure the quality management of a laboratory or for the weights and measures officer supervising the laboratory, to have a simple method to control the standard capacity measures when there is doubt as to their accuracy.

This article discusses a simple procedure used to test, with a reference standard, standard capacity measures of the same type and hierarchy level as the reference standard which is at the controller's disposition. Obviously the uncertainty will be larger than what could be achieved by a laboratory gravimetric test, but it is sufficient for the objective of keeping working standards under control which are handled roughly by servicemen and only the test uncertainty ratio will be considered.

## 1 The standard capacity measures to be controlled

The standard capacity measures to be controlled are of the cylindrical type with narrow neck and sight glass window embedded in the neck to enlarge the sensitivity around the nominal capacity of the measure. Usually there are two sight glasses, one opposite the other, and the smallest graduation is equal to the maximum permissible error (mpe) of the measure which is equal to 1/2000 of the nominal capacity of the standard [3,4].



Photo 1: A set of Italian standard capacity measures for the verification of fuel dispensers (courtesy of LS Laboratorio Strumentazioni - via Padre Michele, 49 15050 Carbonara Scrivia - AL)

The reference capacity measures used by a weights and measures officer supervising the work of accredited laboratories are of the same type, and are often tested at the office by means of gravimetric methods to achieve a lower test uncertainty.



Photo 2: A verification session

In the course of a verification session under the control of an inspector (state officer or the quality manager of the accredited laboratory), it is necessary to verify that the working standards have not suffered from any rough handling that could affect their accuracy. The inspector's standards may be compared with the reference standard to check their error compliance. For the comparison, which takes place in the field, the following assumptions are made:

1. the temperature of the water used in the comparison must remain uniform during the water transfer within 1 °C from the reference standard to the working standard;
2. the expansion coefficient of the working standard and the reference standard are known;
3. the reference standard has preferably been tested using a gravimetric method so that its uncertainty is as small as possible and a test report is available to assure metrological traceability.

## 2 The test method

The volume at 15 °C of the water contained in a capacity measure at temperature  $t$  ( $t$  is the temperature of the water and also of the capacity measure because thermal equilibrium is assumed to exist) is:

$$V_{15} = V_t \cdot [1 + \beta \cdot (t - 15)] [1 + \alpha \cdot (15 - t)] \quad (1)$$

Where:

- $V_t$  is the reading of the meniscus at the sight glass of the capacity measure,
- $\beta$  is the expansion coefficient of the capacity measure,
- $\alpha$  is the expansion coefficient of the water,
- $t$  is the temperature of the water and of the capacity measure.

Equation (1) can be written as

$$V_{15} = V_t \cdot [1 + (\beta - \alpha) \cdot (t - 15)] \quad (2)$$

because, usually,  $(\beta \cdot \alpha) \cdot (t - 15)^2$  is negligible at ordinary temperatures.

Applying equation (2) to the reference standard and to the working standard, we obtain:

$$V_{R15} = V_{IR} \cdot [1 + (\beta_R - \alpha) \cdot (t - 15)] \quad (3)$$

$$V_{S15} = V_{IS} \cdot [1 + (\beta_S - \alpha) \cdot (t - 15)] \quad (4)$$

The error, at 15 °C, is thus:

$$E = V_{S15} - V_{R15} = V_{IS} \cdot [1 + (\beta_S - \alpha) \cdot (t - 15)] - V_{IR} \cdot [1 + (\beta_R - \alpha) \cdot (t - 15)] \quad (5)$$

Considering as assumed that  $t_R = t_S = t$ , the reading on the sight glass of the working standard, if it were exact, would be:

$$V_{IS} = V_{IR} \cdot [1 + (\beta_S - \beta_R) \cdot (t - 15)] \quad (6)$$

Thus, the real reading of the meniscus of the working standard sight glass  $V'_I$  will give the real error:

$$E = V'_I - V_{IS} = V'_I - V_{IR} \cdot [1 + (\beta_S - \beta_R) \cdot (t - 15)] \quad (7)$$

If the test involves a working standard which is  $N$  times greater than the reference standard, we have:

$$V_{SI} = [1 + (\beta_S - \beta_R) \cdot (t - 15)] \cdot \sum_{i=1}^N V_{IRi} \quad (6')$$

And the error  $E$  will be:

$$E = V_{SI}' - V_{SI} = V_{SI}' - [1 + (\beta_S - \beta_R) \cdot (t - 15)] \cdot \sum_{i=1}^N V_{IRi} \quad (7')$$

## 3 Uncertainty budget of the method

The main components of uncertainty in the comparison error are due to:

1. the uncertainty of the reference standard;
2. the reading of the reference standard meniscus at the time of comparison;
3. the reading of the working standard meniscus at the time of comparison;
4. the real temperature difference during the transfer of water from the reference standard to the working standard (it is assumed that it never exceeds 1 °C);
5. the repeatability over two consecutive test runs.

Let us calculate the sensitivity coefficients of the standard uncertainty indicated above in the case of a comparison involving a reference standard and a working standard having the same nominal capacity of 20 L.

Sensitivity coefficient for the reading error on the working standard:

$$\frac{\partial E}{\partial V'_I} = 1$$

Sensitivity coefficient for the reference standard:

$$\frac{\partial E}{\partial V_R} = -[1 + (\beta_S - \beta_R) \cdot (t - 15)] \approx 1$$

for ordinary temperature values.

Sensitivity coefficient for the temperature:

$$\frac{\partial E}{\partial t} = -V_{IR} \cdot (\beta_S - \beta_R)$$

Assuming that the uncertainty component due to the meniscus reading may be calculated as a "type B" standard uncertainty with a triangular probability



density function centred on the graduation line with the zero value at the midpoint between two consecutive graduations, we have, indicating by  $d$  the graduation interval:

$$u^2(V_i) = \frac{d^2}{24}$$

In addition to the uncertainty component for the reading of the reference standard, a component due to the gravimetric calibration of the reference standard,  $u_R$ , must be considered.

For the uncertainty due to the temperature difference during the calibration run it may be assumed that the difference is never greater than 1 °C, with a rectangular distribution centred at the average temperature,  $t$ .

The uncertainty due to the variability of the process can be estimated by performing two calibration runs and assuming that the standard uncertainty can be modelled by a rectangular distribution having its extremes at the two calibration values found.

Under these conditions the uncertainty budget is as shown in the table at the bottom of this page.

Thus, the combined standard uncertainty is:

$$u_c = \sqrt{u_R^2 + \frac{d_R^2}{24} + \frac{d_S^2}{24} + \frac{V_{nom}^2 (\beta_S - \beta_R)^2 \Delta t^2}{12} + \frac{(V_{I1}' - V_{I2}')^2}{12}}$$

Choosing a coverage factor  $k = 2$ , the expanded uncertainty is  $U = 2u_c$ .

## Conclusions

In order to have a working standard which complies with the TUR (Test Uncertainty Ratio) rule, i.e.:

$$TUR \leq \frac{1}{3}$$

the following compliance relations must hold:

$$\bar{E} + U \leq \frac{mpe}{3}$$

$$\bar{E} - U \geq -\frac{mpe}{3}$$

Where  $mpe$  is the maximum permissible error of the dispensing device,  $\bar{E}$  is the average error found for the working standard, and  $U$  is the expanded uncertainty calculated as in the paragraph above.

A worked out example is provided on page 16. 

Table: Uncertainty components

	Uncertainty due to:	Distribution		Sensitivity factor	Standard uncertainty, $u_i$
1	Reference standard	From calibration report	$u_R$	1	$u_R$
2	Reference standard reading	Triangular	$\frac{d_R}{2\sqrt{6}}$	1	$\frac{d_R}{2\sqrt{6}}$
3	Working standard reading	Triangular	$\frac{d_S}{2\sqrt{6}}$	-1	$-\frac{d_S}{2\sqrt{6}}$
4	Temperature difference	Rectangular	$\frac{\Delta t}{2\sqrt{3}}$	$-V_{nom} \cdot (\beta_S - \beta_R)$	$-V_{nom} \cdot (\beta_S - \beta_R) \frac{\Delta t}{2\sqrt{3}}$
5	Repeatability	Rectangular	$\frac{V_{I1}' - V_{I2}'}{2\sqrt{3}}$	1	$\frac{V_{I1}' - V_{I2}'}{2\sqrt{3}}$

**Worked out example**

Let us assume that a 20 L capacity measure working standard has to be verified against a reference standard having the following characteristics:

$$V_{nom} = 20\,000 \text{ mL}$$

$$d_R = 10 \text{ mL}$$

$$\beta_R = 4 \times 10^{-4} \text{ }^\circ\text{C}^{-1}$$

$$u_R = 4 \text{ mL}$$

The working standard has:

$$V_{nom} = 20\,000 \text{ mL}$$

$$d_S = 10 \text{ mL}$$

$$\beta_S = 5 \times 10^{-4} \text{ }^\circ\text{C}^{-1}$$

The comparison temperature is  $t = 18 \text{ }^\circ\text{C}$  during the whole procedure and the two consecutive readings at the reference standard give  $V_{IR} = 20\,000 \text{ mL}$ . We have thus in both cases:

$$V_{IS1} = V_{IS2} = 20000 [1 + (5 \times 10^{-4} - 4 \times 10^{-4}) \cdot (18 - 15)] = 20006 \text{ mL}$$

In both consecutive runs the indication on the sight glass of the working standards is:

$$V'_{IS1} = V'_{IS2} = 20010 \text{ mL}$$

Thus the average error is  $\bar{E} = 4 \text{ mL}$ .

The mpe of the dispensing device is 100 mL. Calculating the uncertainty as shown above we have:

$$U = 2 \cdot \sqrt{u_R^2 + \frac{d_R^2}{24} + \frac{d_S^2}{24} + \frac{V_{nom}^2 (\beta_S - \beta_R)^2 \Delta t^2}{12} + \frac{(V_{I1}' - V_{I2}')^2}{12}}$$

$$= 2 \cdot \sqrt{4^2 + 2.04^2 + 2.04^2 + \frac{20000^2 \cdot 10^{-8} \cdot 1}{12} + 0} =$$

$$= 2 \cdot \sqrt{16 + 4.16 + 4.16 + 0.33 + 0} = 9.9 \text{ mL}$$

With these found values, the compliance relation above holds and we can thus conclude that the working standard has passed the metrological confirmation and may therefore be used as fit for the purpose of verifying fuel dispensing devices. ■

**References**

- [1] Decreto del Ministero dello Sviluppo Economico n. 182 del 28/3/2000
- [2] Decreto del Ministero dello Sviluppo Economico del 10/12/2001
- [3] NISTIR 7383 *Selected Procedures for Volumetric Calibration (2012 Edition) – Standard Operating Procedure No. 16*
- [4] OIML R 120 *Standard capacity measures for testing measuring systems for liquids other than water*

**The Author:**

Giuseppe Ardimento, Deputy Director  
Market Regulatory Service and Consumers Affairs  
Camera di Commercio di Napoli, Italy



## VOLUME

# Metrological confirmation of volume measuring systems installed at PETROBRAS' fuel road tanker loading terminals

CRHISTIAN RAFFAELLO BALDO and ÉRICO VIEIRA PORTO

### Introduction

In Brazil, refined oil products and biofuel are mainly distributed using road tankers. Besides transporting, these tankers also have the role of measuring the volume of the fuel, using the tank as a material measure. This role is important in the distribution activity, since it allows the buyer to acknowledge that the correct amount of fuel has been delivered. It comes from the *Metrology Technical Regulation* referred to by INMETRO Ordinance 059 of 19 March 1993 [1], which guarantees to the buyer (e.g. a filling station) that fuel volume is, within tolerated limits, the volume stated by the distributor. However, establishing each compartment as a material measure (in fact, each compartment only has a single reference mark) results in a major limitation: there is no possibility to choose the volume loaded in each compartment. It is necessary to fill it up to the nominal value at which it has been verified and adjusted.

On the other hand, fuel-loading terminals have dynamic volume meters coupled to the loading arm installation that is part of the road tanker loading platforms. The most common volume meters found in fuel-loading terminals are the turbine meter and the positive displacement meter. In general, they are part of a complete measurement solution that allows automatic control of the fuel-loading operation. From the legal metrology perspective, however, volume meters are unable to provide measurement traceability, which is a role of the material measure defined by a single volumetric mark in the road tanker. Nevertheless, the metrological reliability of the fuel-loading process has to be ensured with lower measurement errors and losses must be kept at a satisfactory level.

This paper describes some practices observed at fuel-loading terminals for the metrological confirmation of volume meters. Special attention is paid to the

evaluation of the measurement uncertainty associated with the interrelated processes. This work is of great importance to the future implementation and certification of a measurement management system, as specified in ISO 10012 [2].

## 1 Periodic verification of volume meters

At fuel-loading terminals, the volume meter that controls the amount of fuel filled into a vehicle tank is verified periodically against a measurement standard, which may be a compact prover or a volumetric tank. The periodic verification may be performed by the terminal maintenance sector or by third-party laboratories, preferably capable of demonstrating their technical competence in accordance with ISO/IEC 17025 [3].

### 1.1 Volume meter verification using a proving tank

Volume meter verification using a proving tank comprises comparing the volume delivered by a volume meter with the reference value indicated by the proving tank scale. The mathematical model that describes the reference volume measured by the proving tank may be expressed as follows:

$$V_{VM} = V_{SCM} [1 + \beta_L (t_{L,SCM} - t_{L,VM}) + \gamma_{SCM} (t_{SCM} - t_{0SCM})] \times C_{L,VM} + \partial V_{res} + \partial V_{rep} + \partial V_{add}$$

Where:

- $V_{VM}$  Volume indicated by the meter at  $t_{0SCM}$  °C
- $V_{SCM}$  Volume of the standard capacity measure at  $t_{0SCM}$  °C
- $t_{0SCM}$  Reference temperature of the standard capacity measure (20 °C)
- $t_{SCM}$  Temperature of the standard capacity measure shell, in °C
- $t_{L,VM}$  Temperature of the liquid in the volume meter, in °C
- $t_{L,SCM}$  Temperature of the liquid in the standard capacity measure, in °C
- $\gamma_{SCM}$  Coefficient of cubical thermal expansion of the standard capacity measure material, in °C<sup>-1</sup>
- $c_{L,VM}$  Correction factor for the effect of pressure on the liquid
- $\beta_L$  Coefficient of cubical thermal expansion of the liquid, in °C<sup>-1</sup>
- $\partial V_{res}$  Resolution of the standard capacity measure, in dm<sup>3</sup>
- $\partial V_{rep}$  Volume meter repeatability, in dm<sup>3</sup>
- $\partial V_{add}$  Additional uncertainty factors, in dm<sup>3</sup>

The volume defined by the standard capacity measure ( $V_{SCM}$ ) is of utmost importance when proving volume meters. Large proving tanks are normally calibrated using the volumetric method, which consists of delivering a quantity of liquid from (or to) a reference standard, to (or from) a proving tank. The expanded measurement uncertainty stated in the calibration certificate of the proving tank and drift between calibrations shall be accounted for in the verification uncertainty budget. The same applies to the scale resolution of the proving tank.

The liquid temperature inside the proving tank ( $t_{1,SCM}$ ) needs to be measured just after reading the indicated volume, using calibrated thermometers with a resolution of 0.1 °C. Thermometer drift and resolution also affect the uncertainty. Due to the physical dimensions of the proving tank, usually more than one thermometer is used, located at different heights. The temperature readings are averaged and the range calculated to estimate the spatial gradient. A similar procedure needs to be employed for the tank shell temperature ( $t_{SCM}$ ) and the liquid temperature in the volume meter ( $t_{1,VM}$ ).

Typically, volume meter verification involves three repeated readings for particular operating conditions, such as flow rate, viscosity, and temperature. The standard uncertainty is given by the experimental standard deviation of the arithmetic mean. In addition, the presence of air bubbles in the liquid, retained liquid (for the filling method) or liquid evaporation may be considered in specific cases. Based on experience, an error limit of 0.01 % is attributed to those additional factors.

### 1.1.1 Uncertainty associated with the volume meter verification using a proving tank

Table 1 shows the uncertainty budget relative to the volume meter verification against a proving tank. The input values correspond to common conditions observed at fuel-loading terminals. From the uncertainty budget, one can observe a combined standard uncertainty of 3.1 dm<sup>3</sup> and an expanded uncertainty of 6.2 dm<sup>3</sup> ( $k = 2$ ) with a relative uncertainty of 0.12 %. Since the volume meter proving is not performed at the reference temperature, the measured volume will be biased by 3.9 dm<sup>3</sup>. For those situations in which the known correction for systematic temperature effect is not applied, that bias is added to the expanded uncertainty, resulting in a “relative total uncertainty” of 0.20 %.

## 1.2 Volume meter verification using a compact prover

Verification using a compact prover consists of mounting it in series with the volume meter under test and comparing the volume indicated by each measuring system. The meter error (correction) can then be determined. The mathematical model that describes the reference volume indicated by the compact prover is similar to the case above:

$$V_{VM} = V_{CP} [1 + \beta_L (t_{LCP} - t_{LVM}) + \gamma_{CP} (t_{CP} - t_{0CP})] \times C_{LVM} + \partial V_{res} + \partial V_{rep} + \partial V_{add}$$

The uncertainty components to be accounted for were also described in the previous case above. However, there is no need to consider the temperature gradient of the liquid.

### 1.2.1 Uncertainty associated with the volume meter verification using a compact prover

Table 2 shows the uncertainty budget relative to the volume meter verification against a compact prover (nominal volume of 60 dm<sup>3</sup>). The input values correspond to common conditions observed at fuel-loading terminals. From the uncertainty budget, one can observe a combined standard uncertainty of 0.02 dm<sup>3</sup> and an expanded uncertainty of 0.04 dm<sup>3</sup> ( $k = 2$ ) with a relative uncertainty of 0.07 %. Since the volume meter proving is not performed at the reference temperature, the measured volume will be biased by 0.1 dm<sup>3</sup>. For those situations in which the known correction for systematic temperature effect is not applied, the bias is added to the expanded uncertainty, resulting in a “relative total uncertainty” of 0.18 %.

## 2 Fuel-loading operation of road tankers

The fuel-loading operation using in-line volume meters may be simplified by five main agents: fuel, tank vehicle, operator, loading arm, and volume meter. Gasoline, biodiesel, diesel, hydrated ethanol and anhydrous ethanol (to blend with gasoline) are the possible products, which feature particular properties (density, viscosity and coefficient of cubical thermal expansion). The mathematical relationship that describes the volume filled in the compartment using a volume meter is the following:

$$V_{0VM} = V_{VM} [1 - \beta_L (t_{LVM} - t_{0VM})] + \partial V_{res} + \partial V_{rep} + \partial V_{add}$$

Where:

- $V_{0VM}$  Fuel volume delivered by the meter at  $t_{0VM}$  °C
- $V_{VM}$  Fuel volume delivered by the meter at  $t_{1VM}$  °C
- $t_{0VM}$  Reference temperature (20 °C)
- $t_{1VM}$  Average temperature of the liquid in the meter, in °C
- $\beta_L$  Coefficient of cubical thermal expansion of the liquid, in °C<sup>-1</sup>
- $\delta V_{res}$  Resolution of the volume meter reading, in dm<sup>3</sup>
- $\delta V_{rep}$  Repeatability of the volume meter, in dm<sup>3</sup>
- $\delta V_{add}$  Additional uncertainty factors, in dm<sup>3</sup>

The volume measured by the volume meter ( $V_{VM}$ ) is of utmost importance when determining the conventional volume. The volume meter is calibrated as described above. The verification method using the proving tank is likely to deliver lower uncertainties, although this is not always true. The expanded uncertainty stated in the meter proving report and drift between proving runs shall be accounted for in the uncertainty budget. The same applies to the reading resolution of the volume meter.

The liquid temperature inside the volume meter ( $t_{1VM}$ ) needs to be measured just after reading the indicated volume, using thermometers with a resolution of 0.1 °C. Thermometer drift and resolution also contribute to the uncertainty. The volume meter repeatability could be addressed from repeated observations (type A evaluation of standard uncertainty). In practice, however, the repeatability is estimated from the manufacturer's specification. In addition, the presence of air bubbles in the liquid or liquid evaporation may be considered in specific cases. For gasoline blended with 25 % of anhydrous ethanol, an evaporation loss of about 200 g per 1000 dm<sup>3</sup> is estimated [4].

## 2.1 Combined uncertainty associated with the fuel-loading operation

The evaluation of the uncertainty associated with the fuel-loading operation based on ISO 5168 [5] and the GUM [6] is summarized in Table 3. The volume meter is checked against a proving tank. The input values correspond to common conditions observed at fuel-loading terminals. From the uncertainty budget, one can observe a combined standard uncertainty of 5.13 dm<sup>3</sup> and an expanded uncertainty of 10.3 dm<sup>3</sup> ( $k = 2$ ) with a relative uncertainty of 0.21 %. The dominant uncertainty component is associated with the volume meter proving after temperature correction to 20 °C.

However, the fuel volume is not corrected to the reference temperature when filling road tankers for

custody transfer from distribution to the filling station. The nominal volume defined by the verified compartment of the road tanker is taken as the conventional volume. That means there is an additional uncertainty contribution related to the lack of fuel delivered if the temperature is above the reference temperature. In Table 4, the effect of an uncorrected fuel volume is illustrated (considering 25 °C). There is a bias of 23.8 dm<sup>3</sup> ± 10.6 dm<sup>3</sup>.

## 3 Discussion and concluding remarks

The uncertainty associated with the corrected volume indicated by the meter during road tanker loading is inferior to the maximum permissible error applied to single volumetric mark of a road tanker compartment (MPE = ± 0.5 %) [1]. Higher metrological reliability is one of the positive factors of using volume meter readings instead of the volumetric mark. Safety, together with the environmental and operational advantages may be also highlighted. On the other hand, good metrology practices need to be observed in fuel-loading terminals in order to optimize the use of in-line volume meters. The fuel-loading operation needs to be predictable and capable (i.e. with a known uncertainty and feasible). Otherwise, the metrological traceability would be at risk and so would any comparison with the values indicated by the volume meter.

Therefore, the implementation and certification of a measurement management system in accordance with the ISO 10012 requirements are recommended for the continuous improvement of metrology processes. From the implementation of a measurement management system, the following achievements are expected at fuel-loading terminals:

- loading terminals using adjustment, calibration and verification methods validated and harmonized, independent of the master employed (proving tank or compact prover);
- loading terminals using measuring instruments with similar and suitable metrological characteristics, as defined in OIML R 117-1 [7];
- loading terminals specifying metrological requirements and performing harmonized metrological confirmation processes (calibration, verification, uncertainty);
- loading terminals making reliable decisions about volume meter calibration intervals using statistical process control techniques. ■

Table 1 Uncertainty budget related to the volume meter proving process using a proving tank

Influence factor	Nominal value		Error limit	Divisor	Symbol	Standard uncertainty		Sensitivity coefficient	Standard uncertainty
standard capacity measure (SCM)	$V_{SCM}$	5000.0							
calibration uncertainty			1.50	2.00	$u_{cal}(V_{SCM})$	0.750	dm <sup>3</sup>	1.00	0.750 dm <sup>3</sup>
drift between calibrations			0.50	3.46	$u_{drift}(V_{SCM})$	0.144	dm <sup>3</sup>	1.00	0.144 dm <sup>3</sup>
fuel temperature of the VM	$t_{L,VM}$	25.0							
calibration uncertainty			0.20	2.00	$u_{cal}(t_{L,VM})$	0.100	°C	4.75	0.475 dm <sup>3</sup>
drift between calibrations			0.10	3.46	$u_{drift}(t_{L,VM})$	0.029	°C	4.75	0.137 dm <sup>3</sup>
temperature gradients			0.25	3.46	$u_{\Delta t}(t_{L,VM})$	0.072	°C	4.75	0.343 dm <sup>3</sup>
thermometer resolution			0.10	3.46	$u_{res}(t_{L,VM})$	0.029	°C	4.75	0.137 dm <sup>3</sup>
fuel temperature of the SCM	$t_{L,SCM}$	25.0							
calibration uncertainty			0.20	2.00	$u_{cal}(t_{L,SCM})$	0.100	°C	-4.75	-0.475 dm <sup>3</sup>
drift between calibrations			0.10	3.46	$u_{drift}(t_{L,SCM})$	0.029	°C	-4.75	-0.137 dm <sup>3</sup>
temperature gradients			2.00	3.46	$u_{\Delta t}(t_{L,SCM})$	0.577	°C	-4.75	-2.742 dm <sup>3</sup>
thermometer resolution			0.10	3.46	$u_{res}(t_{L,SCM})$	0.029	°C	-4.75	-0.137 dm <sup>3</sup>
shell temperature of the SCM	$t_{SCM}$	35.0							
calibration uncertainty			0.20	2.00	$u_{cal}(t_{SCM})$	0.100	°C	0.26	0.026 dm <sup>3</sup>
drift between calibrations			0.10	3.46	$u_{drift}(t_{SCM})$	0.029	°C	0.26	0.007 dm <sup>3</sup>
temperature gradients			2.00	3.46	$u_{\Delta t}(t_{SCM})$	0.577	°C	0.26	0.150 dm <sup>3</sup>
thermometer resolution			0.10	3.46	$u_{res}(t_{SCM})$	0.029	°C	0.26	0.007 dm <sup>3</sup>
expansion coefficient of the SCM	$\gamma_{SCM}$	5.2E-05	5.2E-06	1.73	$u(\gamma_{SCM})$	3.0E-06	°C <sup>-1</sup>	75000.00	0.225 dm <sup>3</sup>
<i>gasoline</i>									
expansion coefficient of the fuel	$\beta_L$	9.5E-04	9.5E-05	1.73	$u(\beta_L)$	5.5E-05	°C <sup>-1</sup>	0.00	0.000 dm <sup>3</sup>
sight glass reading of the SCM		0.00	1.25	3.46	$u(\delta V_{res})$	0.361	dm <sup>3</sup>	1.00	0.361 dm <sup>3</sup>
scale resolution of the VM		0.00	0.50	3.46	$u(\delta V_{res,vm})$	0.144	dm <sup>3</sup>	1.00	0.144 dm <sup>3</sup>
measurement repeatability		0.00	1.25	1.73	$u(\delta V_{rep})$	0.722	dm <sup>3</sup>	1.00	0.722 dm <sup>3</sup>
additional uncertainty factors		0.00	0.00	1.73	$u(\delta V_{add})$	0.000	dm <sup>3</sup>	1.00	0.000 dm <sup>3</sup>
$V_{vm} = V_{scm} \cdot (1 + \gamma_{scm} \cdot (t_{scm} - 20) + \beta_L \cdot (t_{scm} - t_{L,vm}))$									
fuel temperature (average)	$t_L$	25.0	volume @ 20 °C			$V$	5003.89 dm <sup>3</sup>		
reference temperature	$t_0$	20.0	combined uncertainty			$k$	$u_c$	3.08 dm <sup>3</sup>	
			expanded uncertainty			2.00	$U$	6.2 dm <sup>3</sup>	
			relative uncertainty ratio				$U/V$	0.12 %	
			meter error				$e$	3.9 dm <sup>3</sup>	
			relative error ratio				$e/V$	0.08 %	
			"total uncertainty"				$U_T$	10.1 dm <sup>3</sup>	
			"relative total uncertainty"				$U_T/V$	0.20 %	

Table 2 Uncertainty budget related to the volume meter proving process using a compact prover

Influence factors	Nominal value		Error limit	Divisor	Symbol	Standard uncertainty		Sensitivity coefficient	Standard uncertainty	
compact prover (CP)	$V_{CP}$	60.0								
calibration uncertainty			0.01	2.00	$u_{cal}(V_{CP})$	0.006	dm <sup>3</sup>	1.00	0.006 dm <sup>3</sup>	
drift between calibrations			0.01	3.46	$u_{drift}(V_{CP})$	0.002	dm <sup>3</sup>	1.00	0.002 dm <sup>3</sup>	
fuel temperature of the VM	$t_{L,VM}$	25.0								
calibration uncertainty			0.20	2.00	$u_{cal}(t_{L,VM})$	0.100	°C	0.06	0.006 dm <sup>3</sup>	
drift between calibrations			0.10	3.46	$u_{drift}(t_{L,VM})$	0.029	°C	0.06	0.002 dm <sup>3</sup>	
temperature gradients			0.25	3.46	$u_{\Delta t}(t_{L,VM})$	0.072	°C	0.06	0.004 dm <sup>3</sup>	
thermometer resolution			0.10	3.46	$u_{res}(t_{L,VM})$	0.029	°C	0.06	0.002 dm <sup>3</sup>	
fuel temperature of the CP	$t_{L,CP}$	24.0								
calibration uncertainty			0.20	2.00	$u_{cal}(t_{L,CP})$	0.100	°C	-0.06	-0.006 dm <sup>3</sup>	
drift between calibrations			0.10	3.46	$u_{drift}(t_{L,CP})$	0.029	°C	-0.06	-0.002 dm <sup>3</sup>	
temperature gradients			0.25	3.46	$u_{\Delta t}(t_{L,CP})$	0.072	°C	-0.06	-0.004 dm <sup>3</sup>	
thermometer resolution			0.10	3.46	$u_{res}(t_{L,CP})$	0.029	°C	-0.06	-0.002 dm <sup>3</sup>	
shell temperature of the CP	$t_{CP}$	24.0								
calibration uncertainty			0.20	2.00	$u_{cal}(t_{CP})$	0.100	°C	0.00	0.000 dm <sup>3</sup>	
drift between calibrations			0.10	3.46	$u_{drift}(t_{CP})$	0.029	°C	0.00	0.000 dm <sup>3</sup>	
temperature gradients			0.25	3.46	$u_{\Delta t}(t_{CP})$	0.072	°C	0.00	0.000 dm <sup>3</sup>	
thermometer resolution			0.10	3.46	$u_{res}(t_{CP})$	0.029	°C	0.00	0.000 dm <sup>3</sup>	
expansion coefficient of the CP	$\gamma_{CP}$	3.5E-05	3.5E-06	1.73	$u(\gamma_{CP})$	2.0E-06	°C <sup>-1</sup>	240.00	0.000 dm <sup>3</sup>	
<i>gasoline</i>										
expansion coefficient of the fuel	$\beta_L$	9.5E-04	9.5E-05	1.73	$u(\beta_L)$	5.5E-05	°C <sup>-1</sup>	60.00	0.003 dm <sup>3</sup>	
scale resolution of the VM		0.00	0.05	3.46	$u(\delta V_{res})$	0.014	dm <sup>3</sup>	1.00	0.014 dm <sup>3</sup>	
measurement repeatability_CP		0.00	0.01	1.73	$i(\delta V_{rep,cp})$	0.007	dm <sup>3</sup>	1.00	0.007 dm <sup>3</sup>	
measurement repeatability_VM		0.00	0.02	1.73	$u(\delta V_{rep,vm})$	0.009	dm <sup>3</sup>	1.00	0.009 dm <sup>3</sup>	
additional uncertainty factors		0.00	0.00	1.73	$u(\delta V_{add})$	0.000	dm <sup>3</sup>	1.00	0.000 dm <sup>3</sup>	
$V_{vm} = V_{cp} \cdot (1 + \gamma_{cp} \cdot (t_{cp} - 20) + \beta_L \cdot (t_{L,CP} - t_{L,VM}))$										
fuel temperature (average)	$t_L$	24.5	volume @ 20 °C				$i$		60.07	dm <sup>3</sup>
reference temperature	$t_0$	20.0	combined uncertainty			$k$	$u_c$		0.02	dm <sup>3</sup>
						expanded uncertainty	2.00	$U$	0.0	dm <sup>3</sup>
						relative uncertainty ratio		$U/V$	0.07	%
						meter error		$e$	0.1	dm <sup>3</sup>
						relative error ratio		$e/V$	0.11	%
						"total uncertainty"		$U_T$	0.1	dm <sup>3</sup>
						"relative total uncertainty"		$U_T/V$	0.18	%

Table 3 Uncertainty budget related to the fuel-loading operation using an in-line volume meter

Influence factors	Nominal value		Error limit	Divisor	Symbol	Standard uncertainty	Sensitivity coefficient	Standard uncertainty
displacement performance	$V_0$	5000.0						
proving test uncertainty			10.05	2.00	$u_{\text{ver}}(V_0)$	5.027 dm <sup>3</sup>	1.00	5.027 dm <sup>3</sup>
<i>prover tank</i>								
drift between proving runs			1.00	3.46	$u_{\text{drift}}(V_0)$	0.289 dm <sup>3</sup>	1.00	0.289 dm <sup>3</sup>
fuel temperature of the VM	$t_{\text{L,VM}}$	20.0						
calibration uncertainty			0.20	2.00	$u_{\text{cal}}(t_{\text{L,VM}})$	0.100 °C	4.75	0.475 dm <sup>3</sup>
drift between calibrations			0.10	3.46	$u_{\text{drift}}(t_{\text{L,VM}})$	0.029 °C	4.75	0.137 dm <sup>3</sup>
temperature gradients			0.25	3.46	$u_{\Delta t}(t_{\text{L,VM}})$	0.072 °C	4.75	0.343 dm <sup>3</sup>
thermometer resolution			0.10	3.46	$u_{\text{res}}(t_{\text{L,VM}})$	0.029 °C	4.75	0.137 dm <sup>3</sup>
fuel temperature of the tanker	$t_{\text{L,TV}}$	20.0						
calibration uncertainty			0.00	2.00	$u_{\text{cal}}(t_{\text{L,TV}})$	0.000 °C	0.00	0.000 dm <sup>3</sup>
drift between calibrations			0.00	3.46	$u_{\text{drift}}(t_{\text{L,TV}})$	0.000 °C	0.00	0.000 dm <sup>3</sup>
temperature gradients			0.00	3.46	$u_{\Delta t}(t_{\text{L,TV}})$	0.000 °C	0.00	0.000 dm <sup>3</sup>
thermometer resolution			0.00	3.46	$u_{\text{res}}(t_{\text{L,TV}})$	0.000 °C	0.00	0.000 dm <sup>3</sup>
<i>gasoline</i>								
expansion coefficient of the fuel	$\beta_{\text{L}}$	9.5E-04	9.5E-05	1.73	$u(\beta_{\text{L}})$	5.5E-05 °C <sup>-1</sup>	0.00	0.000 dm <sup>3</sup>
scale resolution of the VM		0.00	0.50	3.46	$u(\delta V_{\text{res}})$	0.144 dm <sup>3</sup>	1.00	0.144 dm <sup>3</sup>
measurement repeatability		0.00	1.25	1.73	$u(\delta V_{\text{rep}})$	0.722 dm <sup>3</sup>	1.00	0.722 dm <sup>3</sup>
additional uncertainty factors		0.00	0.00	1.73	$u(\delta V_{\text{add}})$	0.000 dm <sup>3</sup>	1.00	0.000 dm <sup>3</sup>
$V_0\text{vm} = V_{\text{vm}} \cdot (1 - \text{beta.fuel} \cdot (t_{\text{L,vm}} - 20))$								
reference temperature	$t_0$	20.0	volume @ 20 °C			$V$		5000.00 dm <sup>3</sup>
						$k$	$u_c$	5.13 dm <sup>3</sup>
						2.00	$U$	10.3 dm <sup>3</sup>
							$U/V$	0.21 %
							$e$	0.0 dm <sup>3</sup>
							$e/V$	0.00 %
							$U_T$	10.3 dm <sup>3</sup>
							$U_T/V$	0.21 %



Table 4 Estimated error in the volume delivered by the meter due to deviation from the reference temperature

volume @ 20 °C		$V$	4976.25 dm <sup>3</sup>
combined uncertainty	$k$	$u_c$	5.31 dm <sup>3</sup>
expanded uncertainty	2.00	$U$	10.6 dm <sup>3</sup>
relative uncertainty ratio		$U/V$	0.21 %
meter error		$e$	23.8 dm <sup>3</sup>
relative error ratio		$e/V$	0.48 %
"total uncertainty"		$U_T$	34.4 dm <sup>3</sup>
"relative total uncertainty"		$U_T/V$	0.69 %

## References

- [1] Metrology Technical Regulation *referred to by* INMETRO Ordinance 059 of 19 March 1993. (Originally in Portuguese)
- [2] ISO 10012:2003. Measurement management systems - Requirements for measurement processes and measuring equipment
- [3] ISO/IEC 17025:2005. General requirements for the competence of testing and calibration laboratories
- [4] Souza, A. M. Emission evaluation of volatile organic compounds in road tanker loading operations. Master Dissertation. Federal University of Bahia - UFBA. 2004. (Originally in Portuguese)
- [5] ISO 5168:2005. Measurement of fluid flow - Procedures for the evaluation of uncertainties
- [6] OIML G 1-100:2008. Evaluation of measurement data - Guide to the expression of uncertainty in measurement (GUM)
- [7] OIML R 117-1:2007. Dynamic measuring systems for liquids other than water - Part 1: Metrological and technical requirements

## The Authors



**Christian Raffaello Baldo**

Center for Metrology and Instrumentation (CMI)  
Reference Centers in Innovative Technologies (CERTI Foundation)  
Florianópolis, Santa Catarina, Brazil  
cb@certi.org.br



**Érico Vieira Porto**

Leopoldo Américo Miguez de Mello  
Research and Development Center, PETROBRAS  
Rio de Janeiro, Brazil  
ericoporto@petrobras.com.br



# OIML Systems

## Basic and MAA Certificates registered

2014.12–2015.02

Information: [www.oiml.org](http://www.oiml.org) section “OIML Systems”

### The OIML Basic Certificate System

The *OIML Basic Certificate System for Measuring Instruments* was introduced in 1991 to facilitate administrative procedures and lower the costs associated with the international trade of measuring instruments subject to legal requirements. The System, which was initially called “OIML Certificate System”, is now called the “OIML Basic Certificate System”. The aim is for “OIML Basic Certificates of Conformity” to be clearly distinguished from “OIML MAA Certificates”.

The System provides the possibility for manufacturers to obtain an OIML Basic Certificate and an OIML Basic Evaluation Report (called “Test Report” in the appropriate OIML Recommendations) indicating that a given instrument type complies with the requirements of the relevant OIML International Recommendation.

An OIML Recommendation can automatically be included within the System as soon as all the parts - including the Evaluation Report Format - have been published. Consequently, OIML Issuing Authorities may issue OIML Certificates for the relevant category from the date on which the Evaluation Report Format was published; this date is now given in the column entitled “Uploaded” on the Publications Page.

Other information on the System, particularly concerning the rules and conditions for the application, issue, and use of OIML Certificates, may be found in OIML Publication B 3 *OIML Basic Certificate System for OIML Type Evaluation of Measuring Instruments* (Edition 2011) which may be downloaded from the Publications page of the OIML web site. ■

### The OIML MAA



In addition to the Basic System, the OIML has developed a *Mutual Acceptance Arrangement* (MAA) which is related to OIML Type Evaluations. This Arrangement - and its framework - are defined in OIML B 10 (Edition 2011) *Framework for a Mutual Acceptance Arrangement on OIML Type Evaluations*.

The OIML MAA is an additional tool to the OIML Basic Certificate System in particular to increase the existing mutual confidence through the System. It is still a voluntary system but with the following specific aspects:

- increase in confidence by setting up an evaluation of the Testing Laboratories involved in type testing,
- assistance to Member States who do not have their own test facilities,
- possibility to take into account (in a Declaration of Mutual Confidence, or DoMC) additional national requirements (to those of the relevant OIML Recommendation).

The aim of the MAA is for the participants to accept and utilize MAA Evaluation Reports validated by an OIML MAA Certificate of Conformity. To this end, participants in the MAA are either Issuing Participants or Utilizing Participants.

For manufacturers, it avoids duplication of tests for type approval in different countries.

Participants (Issuing and Utilizing) declare their participation by signing a Declaration of Mutual Confidence (Signed DoMCs). ■

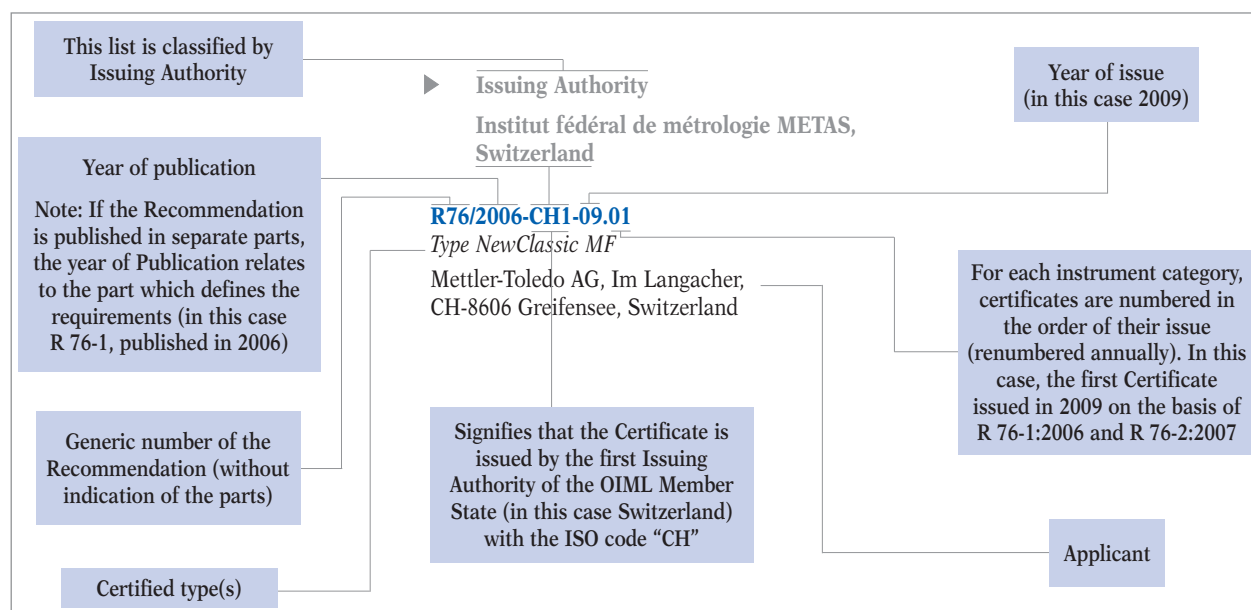

**INSTRUMENT CATEGORY**  
*CATÉGORIE D'INSTRUMENT*
**Taximeters**  
*Taximètres*
**R 21 (2007)**

- Issuing Authority / *Autorité de délivrance*  
 National Measurement Office (NMO),  
 United Kingdom

**R021/2007-GB1-2014.01**

*Taximeter - Type: F1 +*

Italtax S.r.l., Via dell'Industria, 16, I-62017 Porto Recanati (MC), Italy

**R021/2007-GB1-2014.02**

*Taximeter - Type: Force One Navigator*

Italtax S.r.l., Via dell'Industria, 16, I-62017 Porto Recanati (MC), Italy

**R021/2007-GB1-2014.03**

*Taximeter - Type: X-One Plus*

Italtax S.r.l., Via dell'Industria, 16, I-62017 Porto Recanati (MC), Italy

**R021/2007-GB1-2014.04**

*Taximeter - Type: M1-MDT*

Italtax S.r.l., Via dell'Industria, 16, I-62017 Porto Recanati (MC), Italy

**INSTRUMENT CATEGORY**  
*CATÉGORIE D'INSTRUMENT*
**Water meters intended for the metering of cold potable water and hot water**  
*Compteurs d'eau pour le mesurage de l'eau potable froide et de l'eau chaude*
**R 49 (2006)**

- Issuing Authority / *Autorité de délivrance*  
 Czech Metrology Institute (CMI),  
 Czech Republic

**R049/2006-CZ1-2014.02**

*Woltman water meter - Type: TURBO OPTIMA*

PFGROUP FLOWMETER (LEI), 256, Boulevard Ba Hmad, 20300 Casablanca, Morocco

**R049/2006-CZ1-2014.03**

*Multijet water meter - Type: MJ-SDC PLUS*

Ningbo Water Meter Co. Ltd., 355 Hongxing Road, Jiangbei District, CN-315032 Ningbo, P. R. China

**R049/2006-CZ1-2014.04**

*Single jet water meter - Type: SJ-SDC PLUS*

Ningbo Water Meter Co. Ltd., 355 Hongxing Road, Jiangbei District, CN-315032 Ningbo, P. R. China

**R049/2006-CZ1-2014.05**

*Water meter - Type: WPI-SDC*

Ningbo Water Meter Co. Ltd., 355 Hongxing Road, Jiangbei District, CN-315032 Ningbo, P. R. China

- Issuing Authority / *Autorité de délivrance*  
 Laboratoire National de Métrologie et d'Essais,  
 Certification Instruments de Mesure, France

**R049/2006-FR2-2013.01 Rev. 1**

*Water meter ITRON - Type: X61*

ITRON France, 9 rue Ampère, FR-71031 Macon, France

- Issuing Authority / *Autorité de délivrance*  
 Physikalisch-Technische Bundesanstalt (PTB),  
 Germany

**R049/2006-DE1-2015.01**

*Water meter. Electromagnetic flow meter with electronic register - Type: Promag W400*

Endress + Hauser Flowtec AG, Kagenstrasse 7, CH-4153 Reinach BL 1, Switzerland

- Issuing Authority / *Autorité de délivrance*  
 Slovak Legal Metrology (Banska Bystrica),  
 Slovakia

**R049/2006-SK1-2013.01 Rev. 1**

*Family of mechanical volumetric (rotary piston) water meters for metering cold water - Type: PD-A, PD-AP...*

Ningbo Aimei Meter Manufacture Co. Ltd., 68, West Town Road, Shangtian Town, Fenghua City, CN-315511 Zhejiang, P.R. China

**R049/2006-SK1-2014.02 Rev. 1**

*Mechanical multi-jet dry dial water meter for metering of cold water - Type: MD-A; MD-AP*

Ningbo Aimei Meter Manufacture Co. Ltd., 68, West Town Road, Shangtian Town, Fenghua City, CN-315511 Zhejiang, P.R. China

**R049/2006-SK1-2014.03 Rev. 1**

*Mechanical multi-jet dry dial water meter for metering cold water - Type: ML-A;ML-AP*

Ningbo Aimei Meter Manufacture Co. Ltd.,  
68, West Town Road, Shangtian Town, Fenghua City,  
CN-315511 Zhejiang, P.R. China

**INSTRUMENT CATEGORY**  
**CATÉGORIE D'INSTRUMENT**
**Water meters for cold potable water  
and hot water**

*Compteurs d'eau potable froide  
et d'eau chaude*

**R 49 (2013)**

- ▶ Issuing Authority / *Autorité de délivrance*  
Slovak Legal Metrology (Banska Bystrica),  
Slovakia

**R049/2013-SK1-2014.03**

*Mechanical volumetric concentric water meter for metering of cold water - Type: CM, CM1*

Ningbo Aimei Meter Manufacture Co. Ltd.,  
68, West Town Road, Shangtian Town, Fenghua City,  
CN-315511 Zhejiang, P.R. China

**R049/2013-SK1-2014.04**

*Mechanical multi-jet dry dial water meter type for metering of cold water - Type: MD-K, MD-K1, MD-KP,MD-KP1*

Ningbo Aimei Meter Manufacture Co. Ltd.,  
68, West Town Road, Shangtian Town, Fenghua City,  
CN-315511 Zhejiang, P.R. China

**R049/2013-SK1-2014.05**

*Mechanical volumetric dry dial water meter type for metering of cold water - Type: PD-B, PD-BP*

Ningbo Aimei Meter Manufacture Co. Ltd.,  
68, West Town Road, Shangtian Town, Fenghua City,  
CN-315511 Zhejiang, P.R. China

**INSTRUMENT CATEGORY**  
**CATÉGORIE D'INSTRUMENT**
**Automatic catchweighing instruments**  
*Instruments de pesage trieurs-étiqueteurs  
à fonctionnement automatique*
**R 51 (1996)**

- ▶ Issuing Authority / *Autorité de délivrance*  
National Measurement Office (NMO),  
United Kingdom

**R051/1996-GB1-2008.02 Rev. 1**

*Type: LI-700 (weight/weight-price labeler), CWL-700 (checkweigher)*

Digi Europe Ltd., Digi House, Rookwood Way, Haverhill,  
Suffolk CB9 8DG, United Kingdom

**R051/1996-GB1-2014.03 Rev. 1**

*Type: HI-700 (SF), WI-700(SF), CW-700(SF)*

Digi Europe Ltd., Digi House, Rookwood Way, Haverhill,  
Suffolk CB9 8DG, United Kingdom

**INSTRUMENT CATEGORY**  
**CATÉGORIE D'INSTRUMENT**
**Automatic catchweighing instruments**  
*Instruments de pesage trieurs-étiqueteurs  
à fonctionnement automatique*
**R 51 (2006)**

- ▶ Issuing Authority / *Autorité de délivrance*  
NMI Certin B.V.,  
The Netherlands

**R051/2006-NL1-2012.04 Rev. 2**

*Automatic catchweighing instrument -  
Type: AW-4600CPR- . . . , or AW-4600. . .*

Teraoka Seiko Co. Ltd., 13-12 Kugahara, 5-Chome,  
Ohta-ku, JP-146-8580 Tokyo, Japan

**R051/2006-NL1-2014.04 Rev. 1**

*Automatic catchweighing instrument -  
Type: AW-5600, AW-5600CPR*

Teraoka Seiko Co. Ltd., 13-12 Kugahara, 5-Chome,  
Ohta-ku, JP-146-8580 Tokyo, Japan



- Issuing Authority / *Autorité de délivrance*  
National Measurement Office (NMO),  
United Kingdom

**R051/2006-GB1-2009.05 Rev. 2***D3 Checkweigher*Prisma Industriale S.R.L., Via la Bionda, 17,  
IT-43036 Fidenza (PR), Italy**R051/2006-GB1-2009.05 Rev. 3***D3 and T3 Checkweighers*Prisma Industriale S.R.L., Via la Bionda, 17,  
IT-43036 Fidenza (PR), Italy**R051/2006-GB1-2010.01 Rev. 1***Type: WIL-700 and (WIW-700) (weight/weight-price labeller,  
checkweigher)*Digi Europe Ltd., Digi House, Rookwood Way, Haverhill,  
Suffolk CB9 8DG, United Kingdom**R051/2006-GB1-2011.02 Rev. 2***Type: HSC350*Nemesis srl, Via Giulio Benassi 31, IT-41122 Modena,  
Italy**R051/2006-GB1-2012.01 Rev. 1***Type: LI-700E / CWL-700E*Digi Europe Ltd., Digi House, Rookwood Way, Haverhill,  
Suffolk CB9 8DG, United Kingdom**R051/2006-GB1-2013.04 Rev. 1***Type: LI-700-D and CWL-700-D*Digi Europe Ltd., Digi House, Rookwood Way, Haverhill,  
Suffolk CB9 8DG, United Kingdom**INSTRUMENT CATEGORY**  
*CATÉGORIE D'INSTRUMENT***Metrological regulation for load cells**  
**(applicable to analog and/or digital load cells)***Réglementation métrologique des cellules de pesée*  
*(applicable aux cellules de pesée à affichage*  
*analogique et/ou numérique)***R 60 (2000)**

- Issuing Authority / *Autorité de délivrance*  
NMI Certin B.V.,  
The Netherlands

**R060/2000-NL1-2014.25 (MAA)***Compression load cell, with strain gauges - Type: RC3*Flintec GmbH, Bemannsbruch 9, DE-74909 Meckesheim,  
Germany**R060/2000-NL1-2014.26 (MAA)***Single point load cell, with strain gauges - Type: AMI*Keli Electric Manufacturing (Ningbo) Co. Ltd.,  
N° 199 Changxing Road, Jiangbei District,  
CN-315033 Ningbo, P.R. China**R060/2000-NL1-2014.27 (MAA)***Compression load cell, with strain gauges -*  
*Type: YBSCP-SS and YBSCN-SS*Keli Electric Manufacturing (Ningbo) Co. Ltd.,  
N° 199 Changxing Road, Jiangbei District,  
CN-315033 Ningbo, P.R. China**R060/2000-NL1-2014.28 (MAA)***Shear beam load cell, with strain gauges -*  
*Type: SQB-SS 250kg-1t*Keli Electric Manufacturing (Ningbo) Co. Ltd.,  
N° 199 Changxing Road, Jiangbei District,  
CN-315033 Ningbo, P.R. China**R060/2000-NL1-2015.01 (MAA)***Bending beam load cell, with strain gauges -*  
*Type: K-MED/900 or MED-900*Hottinger Baldwin Measurements, Inc., 19 Bartlett Street,  
MA 01752 Marlborough, United States**R060/2000-NL1-2015.02 (MAA)***Shear beam load cell, with strain gauges -*  
*Type: LC-RA-x000Lx, LC-RA-x000Sx*Ravas Europe B.V., Toepadweg 7,  
NL-5201 KA Zaltbommel, The Netherlands**R060/2000-NL1-2015.03 (MAA)***Compression load cell, with strain gauges -*  
*Type: S-TAR/LC03*Tartan Tartı Aletleri San. Tic. Ltd., Sti, 4. San. Sitesi 129/2  
Sk. No:1/13, Izmir, Turkey

- Issuing Authority / *Autorité de délivrance*  
National Measurement Office (NMO),  
United Kingdom

**R060/2000-GB1-2014.04 (MAA)***HK685 stainless steel compression load cell*Krickl Waagen Systeme GmbH, Heid-Werkstr. 13,  
A-2000 Stockerau, Austria

## INSTRUMENT CATEGORY

### CATÉGORIE D'INSTRUMENT

#### Nonautomatic weighing instruments

*Instruments de pesage à fonctionnement non automatique*

#### R 76-1 (1992), R 76-2 (1993)

- Issuing Authority / Autorité de délivrance  
NMI Certin B.V.,  
The Netherlands

#### R076/1992-NL1-2013.01 Rev. 1

*Non-automatic weighing instrument - Type: SWS-5600*  
Teraoka Seiko Co. Ltd., 13-12 Kugahara, 5-Chome,  
Ohta-ku, JP-146-8580 Tokyo, Japan

#### R076/1992-NL1-2013.10 Rev. 1

*Non-automatic weighing instrument - Type: DPS-5600*  
Teraoka Seiko Co. Ltd., 13-12 Kugahara, 5-Chome,  
Ohta-ku, JP-146-8580 Tokyo, Japan

#### R076/1992-NL1-2014.21 Rev. 1

*Non-automatic weighing instrument - Type: AW-5600,  
AW-5600..CP, AW-5600..CPR, AW-5600..EX, AW-5600..FX*  
Teraoka Seiko Co. Ltd., 13-12 Kugahara, 5-Chome,  
Ohta-ku, JP-146-8580 Tokyo, Japan

#### R076/1992-NL1-2014.52 Rev. 2 (MAA)

*Non-automatic weighing instrument - Type: DPS-560*  
Teraoka Seiko Co. Ltd., 13-12 Kugahara, 5-Chome,  
Ohta-ku, JP-146-8580 Tokyo, Japan

#### R076/1992-NL1-2015.02

*Non-automatic weighing instrument - Type: ASP / ATP /  
AHW / AHC / QSP / QTP / QHW / QHC*  
TScale Electronics Mfg (Kunshan). Co. Ltd, No. 99  
Shunchang Road, Zhoushi Town, Kunshan City,  
CN-215300 Suzhou, Jiangsu Province, P.R. China

- Issuing Authority / Autorité de délivrance  
National Measurement Office (NMO),  
United Kingdom

#### R076/1992-GB1-2007.07 Rev. 3

*Huntleigh Healthcare Enterprise 9000, Enterprise 9100,  
9000X and the Citadel hospital beds with weighing facility*  
ArjoHuntleigh AB, Hans Michsensgatan 10,  
211 20 Malmö, Sweden

#### R076/1992-GB1-2007.13 Rev. 3

*Type: DPS-700 and CM-700*  
Digi Europe Ltd., Digi House, Rookwood Way, Haverhill,  
Suffolk CB9 8DG, United Kingdom

#### R076/1992-GB1-2008.09 Rev. 1

*Type: LI-700 (weight/weight-price labeller)*  
Digi Europe Ltd., Digi House, Rookwood Way, Haverhill,  
Suffolk CB9 8DG, United Kingdom

#### R076/1992-GB1-2009.08 Rev. 4

*Type: ABW120*  
Avery Weigh-Tronix, Foundry Lane, Smethwick B66 2LP,  
United Kingdom

#### R076/1992-GB1-2010.06 Rev. 1 (MAA)

*Type: CI-200 Series*  
CAS Corporation, #262, Geurugogae-ro, Gwangjeok-  
myeon, Yangju-si, Gyeonggi-do, Rep. of Korea

#### R076/1992-GB1-2011.02 Rev. 1 (MAA)

*Type: PDI and PDI-S*  
CAS Corporation, #262, Geurugogae-ro, Gwangjeok-  
myeon, Yangju-si, Gyeonggi-do, Rep. of Korea

#### R076/1992-GB1-2013.04 Rev. 2 (MAA)

*Zebra Technologies MP62xx and MP65xx (where xx denotes  
alternative approved models).*  
Zebra Technologies, One Motorola Plaza,  
NY 11742-1300 Holtsville, United States

#### R076/1992-GB1-2015.03

*GP and GPE Series Price Computing Scales*  
Dini Argeo Srl, Via Della Fisica, 20,  
IT-41042 Spezzano di Fiorano (MO), Italy

## INSTRUMENT CATEGORY

### CATÉGORIE D'INSTRUMENT

#### Non-automatic weighing instruments

*Instruments de pesage à fonctionnement non automatique*

#### R 76-1 (2006), R 76-2 (2007)

- Issuing Authority / Autorité de délivrance  
Institut fédéral de métrologie METAS,  
Switzerland

#### R076/2006-CH1-2014.02 (MAA)

*Non-automatic electromechanical weighing instrument -  
Type: NewClassic PL...E/JL...GE*  
Mettler-Toledo AG, Im Langacher 44, CH-8606 Greifensee,  
Switzerland



**R076/2006-CH1-2015.01 (MAA)**

*Non-automatic wheel and axle weighing instrument - Type: SAW. . . III*

IRD Inc., International Road Dynamics, 702-43 rd Street East, CA-S7K 3T9 Saskatoon, Saskatchewan, Canada

**R076/2006-CH1-2015.02 (MAA)**

*Non-automatic analytical/precision weighing instrument - Type: MS. . . TS*

Mettler-Toledo AG, Im Langacher 44, CH-8606 Greifensee, Switzerland

- ▶ **Issuing Authority / Autorité de délivrance**  
Laboratoire National de Métrologie et d'Essais,  
Certification Instruments de Mesure, France

**R076/2006-FR2-2014.02 Rev. 1 (MAA)**

*Digital transmitter - Type: X1104-TR*

Precia SA, BP 106, FR-07001 Privas Cedex, France

**R076/2006-FR2-2014.02 Rev. 2 (MAA)**

*Digital transmitter - Type: X1104-TR*

Precia SA, BP 106, FR-07001 Privas Cedex, France

**R076/2006-FR2-2014.03 Rev. 1 (MAA)**

*Terminal module - Type: X1104-TG*

Precia SA, BP 106, FR-07001 Privas Cedex, France

**R076/2006-FR2-2015.01 Rev. 0 (MAA)**

*Terminal module - Type: X1301*

Precia SA, BP 106, FR-07001 Privas Cedex, France

- ▶ **Issuing Authority / Autorité de délivrance**  
NMI Certin B.V.,  
The Netherlands

**R076/2006-NL1-2013.33 Rev. 1**

*Non-automatic weighing instrument - Type: AW4600 . . .*

Teraoka Seiko Co. Ltd., 13-12 Kugahara, 5-Chome, Ohta-ku, JP-146-8580 Tokyo, Japan

**R076/2006-NL1-2013.34 Rev. 1**

*Non-automatic weighing instrument - Type: DPS-4600 / DPS-4600M*

Teraoka Seiko Co. Ltd., 13-12 Kugahara, 5-Chome, Ohta-ku, JP-146-8580 Tokyo, Japan

**R076/2006-NL1-2014.30 Rev. 1 (MAA)**

*Non-automatic weighing instrument - Type: DPS-5600*

Teraoka Seiko Co. Ltd., 13-12 Kugahara, 5-Chome, Ohta-ku, JP-146-8580 Tokyo, Japan

**R076/2006-NL1-2014.31 Rev. 1 (MAA)**

*Non-automatic weighing instrument - Type, AW-5600, AW5600CP, AW-5600CPR, AW-5600FX*

Teraoka Seiko Co. Ltd., 13-12 Kugahara, 5-Chome, Ohta-ku, JP-146-8580 Tokyo, Japan

**R076/2006-NL1-2014.35 (MAA)**

*Non-automatic weighing instrument - Type: XPE series, XSE series, XVE series*

Mettler-Toledo GmbH, Im Langacher 44, CH-8606 Greifensee, Switzerland

**R076/2006-NL1-2014.43 (MAA)**

*Indicator - Type: STP-20, STP-23, STS-21, STS-21F, STS22*

Satis Co. Limited, Flat B07, Floor 23, Hover Industrial Building, No. 26-38 Kwai Cheong Road, N.T., Hong Kong

**R076/2006-NL1-2014.51 (MAA)**

*Indicator - Type: IND 231/236*

Mettler-Toledo (Changzhou) Measurement Technology Ltd., N° 111, West TaiHu Road, ChangZhou XinBei District, CN-213125 Jiangsu, P.R. China

**R076/2006-NL1-2014.62 (MAA)**

*Indicator - Type: Flying Scale*

Societe FEMA-Airport, Rue de la Belle Borne, Bat 3454 Portes C, F-95722 Roissy Charles de Gaulle Cedex, France

**R076/2006-NL1-2014.63 (MAA)**

*Non-automatic weighing instrument - Type: Cubsican 100-LFT*

Quantronix Inc., 380 South 200 West, P.O. Box 929, 84025 Farmington - Utah, United States

**R076/2006-NL1-2014.64 (MAA)**

*Indicator - Type: STP-100L, STP-100S, STP-200C, STP-200E, STS-100L, STS-100S, STS-200C, STS-200E.*

Satis Co. Limited, Flat B07, Floor 23, Hover Industrial Building, No. 26-38 Kwai Cheong Road, N.T., Hong Kong

**R076/2006-NL1-2015.05**

*Non-automatic weighing instrument - Type: InBody J30 / 230 / 270 / 470*

InBody Co. Ltd., InBody Bldg., 54, Nonhyeon-ro 2-gil, Gangnam-gu, 135-960 Seoul, Rep. of Korea

- ▶ **Issuing Authority / Autorité de délivrance**  
National Measurement Office (NMO),  
United Kingdom

**R076/2006-GB1-2009.02 Rev. 2 (MAA)**

*Type: WPI-700*

Digi Europe Ltd., Digi House, Rookwood Way, Haverhill, Suffolk CB9 8DG, United Kingdom



**R076/2006-GB1-2012.06 Rev. 3 (MAA)***Type: CL3500 Series*

CAS Corporation, #262, Geurugogae-ro, Gwangjeok-myeon, Yangju-si, Gyeonggi-do, Rep. of Korea

**R076/2006-GB1-2012.09 Rev. 2 (MAA)***Type: LI-700E*

Digi Europe Ltd., Digi House, Rookwood Way, Haverhill, Suffolk CB9 8DG, United Kingdom

**R076/2006-GB1-2014.01 Rev. 1 (MAA)***Type: DPS-800s*

Digi Europe Ltd., Digi House, Rookwood Way, Haverhill, Suffolk CB9 8DG, United Kingdom

**R076/2006-GB1-2015.01 (MAA)**

*Price computing scales - BM1-S11-15, BM1-S11-30, BM1-S12-15, BM1-S12-30, BM1-S21-15, BM1-S21-30, BM1-S22-15 and BM1-S22-30*

Balancas Marques de Jose Pimenta Marques, Ltda., Parque Industrial de Celeiros (2a Fase), Apartado 2376, 4701-905 Braga, Portugal

**INSTRUMENT CATEGORY****CATÉGORIE D'INSTRUMENT****Automatic level gauges for fixed storage tanks**

*Jaugeurs automatiques pour les réservoirs de stockage fixes*

**R 85 (2008)**▶ **Issuing Authority / Autorité de délivrance**

Czech Metrology Institute (CMI),  
Czech Republic

**R085/2008-CZ1-2014.02***Magnetostrictive level gauge - Type: XMT*

Start Italiana srl., via Pola 6, I-20030 Bovisio Masciago (MB), Italy

**R085/2008-CZ1-2014.03**

*Automatic level gauge - Type: XMT (probe) / FuelPrime Console (console) / ALEVEL 03 + AMPLI 68 (wireless data transmission)*

AIUT SP. Z o. o., Wyczolkowskiego 113, 44-109 Gliwice, Poland

**R085/2008-CZ1-2014.04**

*Magnetostrictive level gauge - Type: 924B (probe) / SiteSentinel Nano (console)*

OPW Fuel Management Systems, 6900 Santa Fe Drive, IL60525 Hodgkins, Illinois, United States

▶ **Issuing Authority / Autorité de délivrance**

NMi Certin B.V.,  
The Netherlands

**R085/2008-NL1-2014.01**

*Automatic level gauge for measuring the level of liquid in storage tanks, models Smartradar Flexline XP and Smartradar Flexline HP, with indicating device, with the antennas F06, F08, W06, H04, S06, S08, S10 and S12 - Type: Level gauge. SmartRadar Flexiline XP, Level gauge SmartRadar Flexiline HP, Indicating device Smartview*

Enraf B.V., Delftechpark 39, NL-2628 XJ Delft, The Netherlands

▶ **Issuing Authority / Autorité de délivrance**

National Measurement Office (NMO),  
United Kingdom

**R085/2008-GB1-2009.01 Rev. 2**

*Family of probes and consoles used for measuring the level of fuel, or other liquids, in storage tanks*

Gilbarco Veeder Root, Crompton Close, Basildon SS14 3BA, United Kingdom

**INSTRUMENT CATEGORY****CATÉGORIE D'INSTRUMENT****Fuel dispensers for motor vehicles**

*Distributeurs de carburant pour véhicules à moteur*

**R 117 (1995) + R 118 (1995)**▶ **Issuing Authority / Autorité de délivrance**

Russian Research Institute for Metrological Service (VNIIMS)

**R117/1995-RU1-2014.02***Fuel Dispensers Endeavor Series*

Gilbarco-China, Binhe Industrial Zone, Jianshi Rd W, PingGu, CN-101200 Beijing, P.R. China



**INSTRUMENT CATEGORY**  
*CATÉGORIE D'INSTRUMENT*

**Multi-dimensional measuring instruments**  
*Instruments de mesure multidimensionnels*

**R 129 (2000)**

- Issuing Authority / *Autorité de délivrance*  
 NMi Certin B.V.,  
 The Netherlands

**R129/2000-NL1-2013.01**

*Multi-Dimensional Measuring Instrument -  
 Type: DM 3610- . . .*

Datalogic Automation Srl, Via Lavino no. 265,  
 IT-40050 Monte San Pietro, Italy

**R129/2000-NL1-2014.02**

*Multi-Dimensional Measuring Instrument -  
 Type: Cubiscan 100-LFT*

Quantronix Inc., 380 South 200 West, P.O. Box 929,  
 84025 Farmington - Utah, United States

**INSTRUMENT CATEGORY**  
*CATÉGORIE D'INSTRUMENT*

**Automatic instruments for weighing road  
 vehicles in motion and measuring axle loads**  
*Instruments à fonctionnement automatique pour  
 le pesage des véhicules routiers en mouvement et  
 le mesurage des charges à l'essieu*

**R 134 (2006)**

- Issuing Authority / *Autorité de délivrance*  
 Institut fédéral de métrologie METAS,  
 Switzerland

**R134/2006-CH1-2015.01**

*Automatic instruments for weighing road vehicles in  
 motion and measuring axle loads -*

*Type: WIM System 9835A*

Kistler Instrumente AG, Eulachstrasse 22,  
 CH-8408 Winterthur, Switzerland

**INSTRUMENT CATEGORY**  
*CATÉGORIE D'INSTRUMENT*

**Gas meters**  
*Compteurs de gaz*

**R 137 (2012)**

- Issuing Authority / *Autorité de délivrance*  
 NMi Certin B.V.,  
 The Netherlands

**R137/2012-NL1-2014.03 Rev. 0**

*Turbine gas meter - Type: FMT-L, FMT-S, FMT-Lx*

Flow Meter Group B.V., Meniststraat 5c,  
 NL-7091 ZZ Dinxperlo, The Netherlands

**R137/2012-NL1-2015.01**

*Rotary piston gas meter - Type: FMR and FMR-Dual*

Flow Meter Group B.V., Meniststraat 5c,  
 NL-7091 ZZ Dinxperlo, The Netherlands

## Measurements and Light

May 20 is World Metrology Day, commemorating the anniversary of the signing of the Metre Convention in 1875. This treaty provides the basis for a coherent measurement system worldwide.

The theme chosen for 2015 is *Measurements and Light*.

This year, World Metrology Day is aligned with the International Year of Light and Light-based Technologies proclaimed by the General Assembly of the UN and organized by UNESCO. Events in 2015 will celebrate the central role of light to life, whether as a source of energy, as the basis for photonic technologies or as being a source of wonder and excitement. Metrology, the science and application of measurement, plays a central role in enabling the application and advancement of light-based technologies, whether for more efficient energy production, a better understanding of climate change, or optimal lighting of our cities and towns. In turn, light is at the heart of many of the most important new elements of leading-edge measurement technologies.

Across the world, national metrology institutes continually advance measurement science by developing and validating new measurement techniques at whatever level of sophistication is needed. They also participate in comparisons coordinated by the *Bureau International des Poids et Mesures* (BIPM) to ensure the reliability of measurement results worldwide.

Many measuring instruments are controlled by law or are subject to regulatory control, for example the scales used to weigh goods in a shop, instruments to measure environmental pollution, or meters used to bill energy. The *International Organization of Legal Metrology* (OIML) develops international Recommendations, the aim of which is to align and harmonize requirements for these types of instruments worldwide.

World Metrology Day recognizes and celebrates the contribution of all the people that work in intergovernmental and national organizations throughout the year on behalf of all.

Further information, including a message from the Directors, posters, and a list of events, is available at [www.worldmetrologyday.org](http://www.worldmetrologyday.org)

Contact: [wmd@worldmetrologyday.org](mailto:wmd@worldmetrologyday.org)

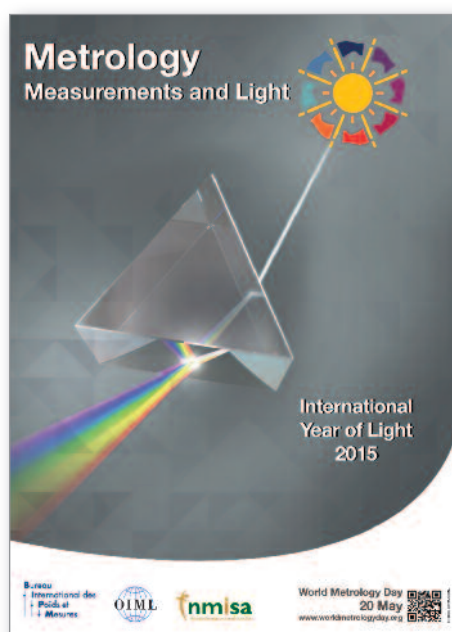



Stephen Patoray  
Director the BIML

## Measurements and Light

As we begin our preparations for World Metrology Day, 2015 and as we consider this year's theme, *Measurements and Light*, I think about how this current theme is very closely related to those of previous World Metrology Days:

- light is important in everyday life (the theme for 2013);
- workplace and street lighting benefit both our health and our safety (the themes for 2006 and 2012 respectively); and
- with the increasing economic growth in many areas of our planet, the demand for more light and therefore more electricity certainly creates a global energy challenge (the theme for 2014).

We live in a highly visual world. Each day we see the sun rising, providing the essential requirements for life itself. Each day a large percentage of the world is able to simply flip a switch and turn on an electric light.

However, a recent article in the Washington Post identified a significant challenge: "The rate of growth in global electrification is slower than the rate of growth of the population". A report from the IEA and the World Bank states: "With regard to universal access, business as usual would leave 12 percent ... of the world's population in 2030 without electricity...".

Without a significant increase in spending or a new direction to solve the problem, this will not change. To compound this issue the UN is also trying to address climate change at the same time – and prevent global temperatures from rising by more than 2 °C. To satisfy both goals, nations around the world would need to improve their energy efficiency and bolster the amount of clean energy they produce and use. This will require

- more measurements to understand and improve the efficiency of electrical appliances,
- an increase in the amount of clean energy produced and consumed, and
- additional international standards that apply directly to this area.

Light can behave either as a wave or a particle, or sometimes as both. This is quite remarkable. Also, as metrologists, we think of light as something that is measured, but we also use it to make measurements, again quite remarkable.

The speed of light in vacuum, commonly denoted  $c$ , is a universal physical constant which is important in many areas of physics. Its defined value is exactly 299 792 458 m/s, as the SI metre is defined from this constant. Distance, speed, temperature, the composition and contaminants in our food and environment, common measurements to legal metrology, can all be measured using various forms of light.

It is with these initial thoughts that I continue to consider with great wonder the phenomenon which we enjoy every day as light. The legal metrology community is pleased to join with UNESCO in marking the *International Year of Light* and I wish you immeasurable happiness and a very bright future.



**Martin Milton**  
*Director of the BIPM*

## Measurements and Light

### *“Metrology for light and light for metrology”*

This year, World Metrology Day is aligned with the International Year of Light and Light-based Technologies proclaimed by the General Assembly of the UN and organized by UNESCO. Events in 2015 will celebrate the central role of light to life, whether as a source of energy, as the basis for photonic technologies or as being a source of wonder and excitement.

Metrology plays a central role in enabling the application of light-based technologies, for example:

- as new forms of efficient lighting are developed new measurements are needed to quantify their efficiency and the influence they have on the appearance of objects,
- decisions to invest in solar photovoltaic technologies are based on accurate data for their efficiency and lifetime,
- direct measurements of the sun made from satellites are essential to underpin our understanding of solar irradiance and its contribution to climate change.

In turn, light is at the heart of many of the most important new elements of leading-edge measurement technologies. For many decades, the most accurate length measurements have depended on highly-stable lasers and many highly-sensitive chemical measurements use tunable lasers that can sense individual transitions in target molecules. The capabilities of stable lasers now extend to providing the most accurate “optical clocks” which depend on the light emitted from single atoms which have been slowed down and trapped by laser beams.

I hope that the celebration of World Metrology Day on 20<sup>th</sup> May 2015 will trigger new liaisons between the metrology community and those who work to develop and exploit light-based technologies. It is the opportunity to show that just as life depends on light, so the safe, efficient and effective supply of light depends on measurement.

## ASEAN

# Legal metrology well prepared for the ASEAN Economic Community

MANFRED KOCHSIEK,  
CIML Past President and PTB Consultant  
HANS-DIETER VELFE, PTB Consultant

The ASEAN Consultative Committee on Standards and Quality – Working Group on Legal Metrology (ACCSQ-WG3) is a grouping of legal metrology authorities in ASEAN. The objectives of this Working Group focus on aligning legal metrology in ASEAN to support the objectives of the ASEAN Free Trade Area (AFTA) and on ensuring that the modernization of legislation in legal metrology by ASEAN Member Countries will not result in the introduction of new technical barriers to trade. The ACCSQ-WG3 has organized numerous activities for the ASEAN Member Countries in preparation for the formation of the ASEAN Economic Community.

In a PTB sponsored workshop conducted on June 2, 2014 in Siem Reap, Cambodia, ASEAN Member States concentrated on best practices in the development of metrology laws in an effort towards a harmonized legal metrology legislation and administration in the region (see OIML Bulletin Vol. LV, October 2014 [1]). A follow-up workshop was held in Jakarta, Indonesia, on Nov 18, 2014 also supported by the PTB with contributions by

Dr. M. Kochsiek and Mr. R. Hahnwald and moderated by Andrea Ulbrich, PTB Project Coordinator.

At the workshops the differences in the Member States' laws and implementation procedures were discussed. Brunei Darussalam, Indonesia, Malaysia, the Philippines, Singapore, Thailand and Vietnam shared information on their existing metrology laws. Subsequently, activities to build up trust and mutual recognition procedures among the ASEAN Member States were considered. These measures will help to avoid duplications for, e.g. product testing or type approvals.

A first activity agreed upon was a benchmarking of the metrology laws of the ten ASEAN Member States. The laws were compared against OIML D 1 *Considerations for a Law on Metrology* [2] and the *ASEAN Trade in Goods Agreement (ATIGA)* [3]. The benchmark results were presented during the second workshop in Jakarta.

- In the first session, Dr. Kochsiek presented the “Results of Benchmarking Metrology Laws and the Next Steps”, covering:
  - i. Results / Outcome of the WG 3- PTB Workshop in Cambodia on June 2, 2014;
  - ii. Objectives of metrology legislation;
  - iii. Benchmark of the laws on metrology of the ASEAN Member States;
  - iv. Summary of the benchmark (see below);
  - v. Follow-up actions.
- Dr. Kochsiek then recommended the following actions to be taken by the ASEAN Member States:
  - i. Considering improvements of relevant law provisions at national level;
  - ii. Consideration of conformity assessment procedures, e.g. type approval. A procedure should be developed regarding how to deal with the problem



ASEAN Workshop participants

of the existence of type approval and/or conformity assessment procedures in only some ASEAN Member States;

- iii. Development of sub-law regulations;
- iv. Consideration of harmonized technical requirements according to
  - OIML Documents and Recommendations,
  - APLMF documents.

The summary of the benchmark results are:

1. OIML D 1 and ATIGA aim at different targets, however, the ATIGA requirements in the field of legal metrology concerning trade in goods are fully compatible with D 1. Thus if the D 1 guidelines are followed, the corresponding ATIGA requirements are fulfilled as well. For a comparison, refer to Table 1.
2. The legal rules and regulations vary considerably in the ten countries, especially concerning the related implementation procedures and practice. For this reason, as a first step, a benchmark was performed focusing on the national laws on metrology. The legislation stemmed from different time periods, some more than 30 years ago and others quite recent. The legislations also differ in their goals (either all areas of metrology, or restricted to legal metrology; in legal metrology again restricted to trade or to selected categories of measuring instruments). Comparing the detailed outcomes of this benchmarking, most findings show great promise for the ASEAN Economic Community. Refer to Table 2.

A current positive development is that some Member States have recently revised their laws on metrology and others are in the process of doing so.

3. It turned out that some countries implemented their by-laws – compared with international best practice – in a satisfactory manner. In several other member states the sub-legislation still needs intensive improvement and harmonization with contemporary requirements.
4. During discussions, participants deplored the non-existence of well-equipped testing laboratories and educated staff for performing type approvals of measuring instruments in about half of the ASEAN Member States. Some countries have not required any type approvals up to now.

Mr. Hahnewald, PTB Key Expert to the Working Group on Legal Metrology, gave a presentation on the need for confidence-building measures and planning for

a comparison among the ASEAN Member States of their procedures on handling imported measuring instruments.

In group discussions the necessary steps to prepare a type approval comparison, based on one of the following possible alternatives were discussed. The alternatives were 1) a measuring instrument is imported with a foreign type approval either a) from an ASEAN Member State or b) from another foreign country; 2) a measuring instrument is imported without any type approval; 3) a measuring instrument is imported with a conformity declaration of the manufacturer.

The three groups discussed and presented the step-by-step process of handling the measuring instrument. The results of three groups are summarized below:

- i. Specific measuring instruments should be selected for a comparison of the procedures of the ASEAN Member States;
- ii. Non-automatic weighing instruments should be chosen based on the agreed guidelines;
- iii. An independent reference laboratory should be used. This could be a laboratory of the PTB or a suitable laboratory in the region;
- iv. Further action is envisaged by WG 3 with support from the PTB.

The ASEAN Working Group on Legal Metrology will consider the relevant OIML Documents and Recommendations concerning national technical regulations in legal metrology, which would also benefit industry in the ASEAN. For the practical implementation the Working Group will consider taking a closer look at the procedures (conformity assessment, type approval, verification, market surveillance) in each ASEAN Member State to better identify areas for future harmonization in legal metrology.

The Workshop was attended by participants from Indonesia, Cambodia, Malaysia, Philippines, Singapore, Thailand and Viet Nam, as well as the experts from the PTB, Germany (see photo). ■

## References

- [1] M. Kochsiek, C. Sanetra, ASEAN Working Group on Legal Metrology (ACCSQ – WG 3), OIML Bulletin Vol. LV, No. 4, October 2014, pp. 38 – 40
- [2] OIML D 1:2012 *Considerations for a Law on Metrology*
- [3] ASEAN Trade in Goods Agreement (ATIGA), ISBN 978-602-7643-52-9, ASEAN Secretariat, July 2013

Table 1

OIML D 1 Element		ATIGA Article(s) - Corresponding provisions	
2	Laws & regulations shall comply with Metre Conv., OIML, WTO TBT - Government shall designate NMI;	73 1.	MS committed to WTO TBT
3	- National measurement standards traceable to SI;	73 2.(b)	- Procedures consistent with international standards & practices;
4	- Provide international compatibility and acceptance; - Appropriate evaluation of NMI (peer assessment/accreditation)	76 2., 4. 76 5.	- Acceptance of results by other MS; - Cooperation among NABs and NMIs incl. legal metrology
5	Certain implementing bodies to be accredited		
6	NMI: Power & resources to negotiate for int. acceptance & recognition		
7	Designation of a Central Metrology Authority;	18 1.	Observance of the ATIGA provisions by the MS central, regional and local government and authorities
8	Designation of a Local Metrology Authority		
10	Measurements, measuring instruments, pre-packages: traceability to SI - either via own national measurement standards, or - via national standards of other countries	76 4.	- Cooperation among NABs and NMIs incl. legal metrology
11	NMI: results of calibrations, tests & measurements must be - traceable to SI, - in compliance with recommendations CGPM and OIML, - in compliance with international standards.		
12	- Definition of legal units; definition of customary units;		
13	- use of other than legal units.		
15	NMI: Source of independent and impartial expertise		
16	Regulations by Government shall aim at (...) - meeting the requirements of international trade	47	Principles on Trade Facilitation
18	Prepackages: - take account of OIML recommendations & international systems for certification of prepackages, - recognition of conformity marks of other countries (conformity marking systems by international bodies)	47	
19	Measuring instruments: in analogy to prepackages (El. 18), additionally: - enter into MRAs, OIML certification system	47	
20	Conformity assessment bodies: - appointment; - competence & impartiality - prove by accreditation; - compliance with WTO TBT Art. 5 & 6	76	Conformity Assessment Procedures
34	Conformity assessment procedures: international recognition	76 4.	MS shall accept the results of CA produced by other MS

Important notes:

Only such D 1 Elements are listed here which have special relevance to the ATIGA Agreement. Nevertheless, observance of many other D 1 Elements may affect the implementation of ATIGA.

Some D 1 Elements listed above do not have direct counterparts in ATIGA (Elements 5, 6, 11, 12, 13, 15). Their observance, however, is an indispensable presupposition for the implementation of other ATIGA provisions.

Table 2

D 1 Element		Country:																																				
no.:		1	2	3	4	5	6	7	8	9	10	11	12	13	14	15	16	17	18	19	20	21	22	23	24	25	26	27	28	29	30	31	32	33	34	35	36	
1		3	3	1	3	3					3	3	2	2		3	3		1	3	3			2	2	2	1			1	1					3		
2		3	2	0	3	3					3	3	2	2		3	1		3	1	3																3	1
3		1	1	1	3	3					3	3	2	2		3	3		1	0	3			1	1	1		2	2	3	2	3					3	
4		1	2	2	2	3	2	2	2	3			3			3	1	1	1	2	2	2					2	2	2	2	2	2	2				2	1
5		3	2	2	3	2				2	1	3		2		3	3		3	3	3																3	
6		3	2	2	2	3	3	3	3	2	2	3	2	2		3	2	2	2	2	2	1		1	2	2	1		1				1		2	2		
7		2	1	2	3	2	2		2	1	3	3		3	1	3	3		2	2	3																1	
8				3	3	3	3	3				3	3	3	3		3	3		3	3	3			2	1			1							3		
9		1	0	3	1	3	3	1	2			3	3	1	1		3	3		1	0	0	1		1											3		
10		2	2	3	2	3	2	1	1		2	3	2	2	2	3	2	2	2	2	1	2				2	2						2		3	2		
<b>Legend:</b>																																						
	0	Not acceptable in the present shape; will probably be acceptable in the forthcoming new law.																																				
	0	Revision for clarification is urgently recommended.																																				
	1	Acceptable, but recommended to change.																																				
	2	Acceptable, no need to change.																																				
	3	Not (or not satisfactorily) regulated in the law; inclusion into legislation (or correction) is recommended.																																				
	n	These D 1 Elements are of special importance for the planned AEC.																																				



## DEVELOPING COUNTRIES

### ANNOUNCING THE

# Seventh OIML Award for Excellent contributions from Developing Countries to legal metrology

### Background

Many developing countries suffer from a lack of resources for the operation of a sound legal metrology system. Although these resources cannot be provided by the OIML, the Organization supports initiatives for the development of legal metrology. To highlight the importance of metrology activities in developing countries, and to provide an incentive for their improvement, in 2009 the OIML established an Award for "Excellent contributions from developing countries to legal metrology".

This Award is intended to raise the awareness of, and create a more favorable environment for legal metrology and to promote the work of the OIML. The Award intends: "to acknowledge and honor new and outstanding activities achieved by individuals, national services or regional legal metrology organizations contributing significantly to legal metrology objectives on national or regional levels."

### How can candidates be proposed?

Nominations may be made by any individuals or organizations concerned with legal metrology, including the individual or organization seeking the Award.

Nominations should be sent to Ian Dunmill at the BIML and must contain facts, documents and arguments explaining why the candidate deserves the Award. The closing date is 1 July 2015.

### Selection procedure

The BIML will prepare a list of candidates highlighting the importance of the achievements, and will rank the applications. The Award winner will be selected by the CIML President and announced at the 50th CIML Meeting in October 2015.

### Selection criteria

The criteria which will be used to assess the candidates' contribution or achievement will include:

- its significance and importance;
- its novelty;
- its attractiveness and adaptability for other legal metrology services.

### The OIML Award

The Award will consist of:

- a Certificate of Appreciation signed by the CIML President;
- a token of appreciation, such as an invitation to make a presentation of the Award-winning achievement at the next CIML Meeting or OIML Conference at the OIML's expense;
- an engraved glass award trophy.

### Further information

For more details, please contact:

#### Ian Dunmill

BIML Assistant Director  
ian.dunmill@oiml.org

### Past Awards

- 2014 - Serbian National Metrology Institute (DMGM)
- 2013 - Weights and Measures Agency (Tanzania)
- 2012 - Loukoumanou Osséni (Benin)
- 2011 - José Antonio Dajes (Peru) and Juan Carlos Castillo (Bolivia)
- 2010 - Thai Legal Metrology Service
- 2009 - Mr. Osama Melhem (Jordan)



The OIML is pleased to welcome the following new

## ■ CIML Member

■ **Switzerland:**  
**Mr. Gregor Dudle**

## ■ OIML meetings

### June 2015

TC 17/SC 7/p 3 Evidential breath analyzers (R 126)  
30 June - 1 July, Verispect / VSL, Delft, The Netherlands

### October 2015

50th CIML Meeting  
Week of 19 October 2015, Arcachon, France

## ■ Committee Draft

Received by the BIML, 2015.01 – 2015.02

New Document: General requirements for the programme of reference material certification

E

2 CD

TC 8/SC 7/p 4

NL

### Bulletin online:

Download the OIML Bulletin  
free of charge

[oiml.org/en/publications/bulletin](http://oiml.org/en/publications/bulletin)

The  
**50th CIML Meeting**  
and Associated Events  
will take place in Arcachon, France  
in the week commencing 19 October 2015



*Website online soon*

# Call for papers

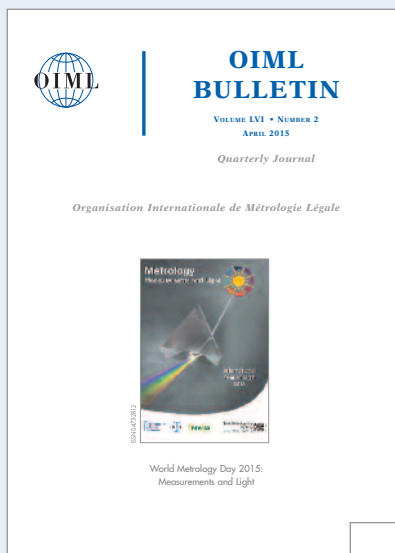

**OIML Members**  
**RLMOs**  
**Liaison Institutions**  
**Manufacturers' Associations**  
**Consumers' & Users' Groups, etc.**



- Technical articles on legal metrology related subjects
- Features on metrology in your country
- Accounts of Seminars, Meetings, Conferences
- Announcements of forthcoming events, etc.



The **OIML Bulletin** is a forum for the publication of technical papers and diverse articles addressing metrological advances in trade, health, the environment and safety - fields in which the credibility of measurement remains a challenging priority. The Editors of the Bulletin encourage the submission of articles covering topics such as national, regional and international activities in legal metrology and related fields, evaluation procedures, accreditation and certification, and measuring techniques and instrumentation. Authors are requested to submit:

- a titled, typed manuscript in Word or WordPerfect either on disk or (preferably) by e-mail;
- the paper originals of any relevant photos, illustrations, diagrams, etc.;
- a photograph of the author(s) suitable for publication together with full contact details: name, position, institution, address, telephone, fax and e-mail.

*Note: Electronic images should be minimum 150 dpi, preferably 300 dpi.*

Technical articles selected for publication will be remunerated at the rate of 23 € per printed page, provided that they have not already been published in other journals. The Editors reserve the right to edit contributions for style, space and linguistic reasons and author approval is always obtained prior to publication. The Editors decline responsibility for any claims made in articles, which are the sole responsibility of the authors concerned. Please send submissions to:

The Editor, OIML Bulletin  
BIML, 11 Rue Turgot, F-75009 Paris, France  
([chris.pulham@oiml.org](mailto:chris.pulham@oiml.org))

