



OIML BULLETIN

VOLUME LV • NUMBER 4

OCTOBER 2014

Quarterly Journal

Organisation Internationale de Métrologie Légale

ISSN 0473-2812

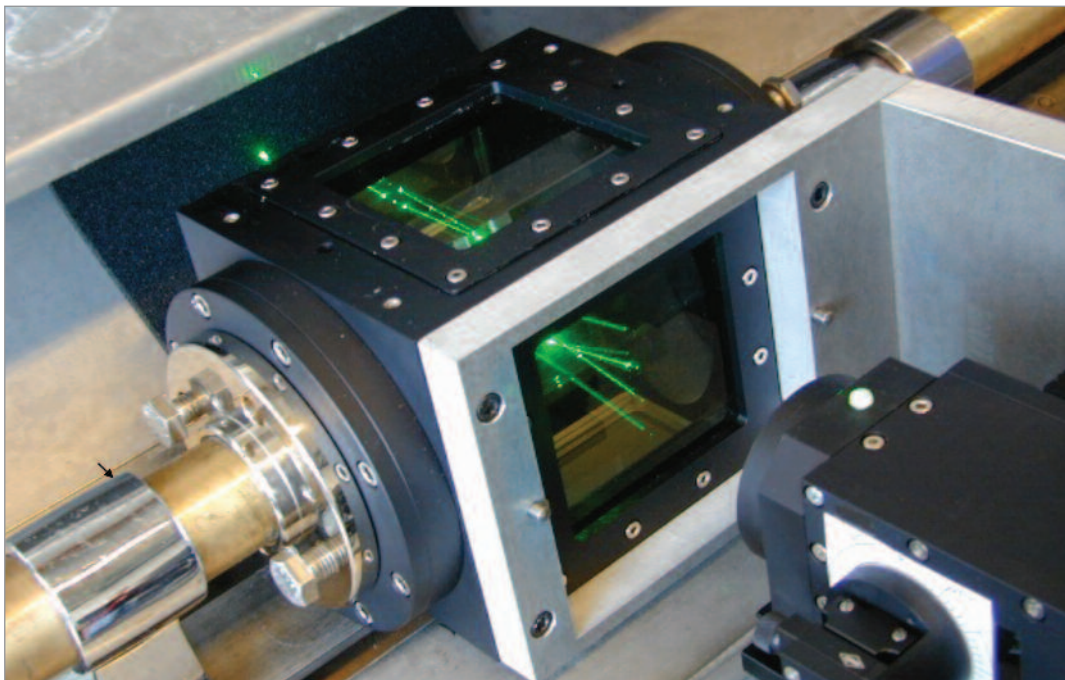

Investigation and characterization of water meter behavior
under different flow conditions



BULLETIN

VOLUME LV • NUMBER 4

OCTOBER 2014

THE OIML BULLETIN IS THE
QUARTERLY JOURNAL OF THE
ORGANISATION INTERNATIONALE
DE MÉTROLOGIE LÉGALE

The Organisation Internationale de Métrologie Légale (OIML), established 12 October 1955, is an inter-governmental organization whose principal aim is to harmonize the regulations and metrological controls applied by the national metrology services of its Members.

EDITOR-IN-CHIEF: Stephen Patoray
EDITOR: Chris Pulham

THE ONLINE BULLETIN IS FREE OF CHARGE

ISSN 0473-2812

PRINTED IN FRANCE

JOSÉ MOYARD IMPRIMEUR
8 RUE ROBERT SCHUMAN
10300 SAINTE SAVINE

OIML PRESIDUM AND PRESIDENTIAL COUNCIL

PRESIDENT

Peter Mason (UNITED KINGDOM)

VICE-PRESIDENTS

Roman Schwartz (GERMANY)
YUKINOBU MIKI (JAPAN)

MEMBERS (IN ALPHABETICAL ORDER)

Stuart Carstens (SOUTH AFRICA)
Pu Changcheng (P.R. CHINA)
Charles D. Ehrlich (UNITED STATES)
Alan E. Johnston (CANADA)
Corinne Lagauterie (FRANCE)
Cees van Mullem (NETHERLANDS)
Philippe Richard (SWITZERLAND)
Valérie Villière (AUSTRALIA)

Stephen Patoray (DIRECTOR OF BIML)

OIML SECRETARIAT BUREAU INTERNATIONAL DE MÉTROLOGIE LÉGALE (BIML)

11 RUE TURGOT - 75009 PARIS - FRANCE

TEL: 33 (0)1 4878 1282

FAX: 33 (0)1 4282 1727

INTERNET: www.oiml.org or www.oiml.int
www.metrologyinfo.org

BIML STAFF

DIRECTOR

Stephen Patoray (stephen.patoray@oiml.org)

ASSISTANT DIRECTORS

Ian Dunmill (ian.dunmill@oiml.org)

Willem Kool (willem.kool@oiml.org)

STAFF MEMBERS (IN ALPHABETICAL ORDER)

Jalil Adnani: Database Systems Management
(jalil.adnani@oiml.org)

Jean-Christophe Esmiol: IT Systems Management
(jean-christophe.esmiol@oiml.org)

Florence Martinie: Administrator, Finance
(florence.martinie@oiml.org)

Luis Mussio: Engineer
(luis.mussio@oiml.org)

Chris Pulham: Editor/Webmaster
(chris.pulham@oiml.org)

Patricia Saint-Germain: Administrator, Members
(patricia.saint-germain@oiml.org)

OIML MEMBER STATES

ALBANIA	KAZAKHSTAN
ALGERIA	KENYA
AUSTRALIA	REP. OF KOREA
AUSTRIA	MACEDONIA, THE FORMER YUGOSLAV REPUBLIC OF
BELARUS	MONACO
BELGIUM	MOROCCO
BRAZIL	NETHERLANDS
BULGARIA	NEW ZEALAND
CAMEROON	NORWAY
CANADA	PAKISTAN
P.R. CHINA	POLAND
COLOMBIA	PORTUGAL
CROATIA	ROMANIA
CUBA	RUSSIAN FEDERATION
CYPRUS	SAUDI ARABIA
CZECH REPUBLIC	SERBIA
DENMARK	SLOVAKIA
EGYPT	SLOVENIA
FINLAND	SOUTH AFRICA
FRANCE	SPAIN
GERMANY	SRI LANKA
GREECE	SWEDEN
HUNGARY	SWITZERLAND
INDIA	TANZANIA
INDONESIA	TUNISIA
ISLAMIC REPUBLIC OF IRAN	TURKEY
IRELAND	UNITED KINGDOM
ISRAEL	UNITED STATES OF AMERICA
ITALY	VIETNAM
JAPAN	ZAMBIA

OIML CORRESPONDING MEMBERS

ARGENTINA	MAURITANIA
BAHRAIN	MAURITIUS
BANGLADESH	MEXICO
BARBADOS	MOLDOVA
BENIN	MONGOLIA
BOSNIA AND HERZEGOVINA	MONTENEGRO
BOTSWANA	MOZAMBIQUE
CAMBODIA	NAMIBIA
COSTA RICA	NEPAL
DOMINICAN REPUBLIC	NIGERIA
ESTONIA	OMAN
FIJI	PANAMA
GABON	PAPUA NEW GUINEA
GAMBIA	PARAGUAY
GEORGIA	PERU
GHANA	QATAR
GUATEMALA	RWANDA
GUINEA	SEYCHELLES
HONG KONG, CHINA	SIERRA LEONE
ICELAND	SINGAPORE
IRAQ	SUDAN
JORDAN	SYRIA
DPR KOREA	CHINESE TAIPEI
KUWAIT	THAILAND
KYRGYZSTAN	TRINIDAD AND TOBAGO
LATVIA	UEMOA
LIBERIA	UGANDA
LIBYA	UKRAINE
LITHUANIA	UNITED ARAB EMIRATES
LUXEMBURG	URUGUAY
MADAGASCAR	UZBEKISTAN
MALAWI	YEMEN
MALAYSIA	ZIMBABWE
MALTA	

■ technique

- 5 Investigation and characterization of water meter behavior under different flow conditions
Gudrun Wendt

■ evolutions

- 15 Technology for totalizing weighing instruments used for receiving and shipping loose bulk products
Wolfgang Euler and Werner Braun
- 26 The development and transformation of national metrology legislation in Ukraine
Oleh Velychko
- 32 Metrology and globalization
Ysabel Reyes Ponce

■ update

- 38 ASEAN Working Group on Legal Metrology
Manfred Kochsiek and C. Sanetra
- 41 OIML Systems: Basic and MAA Certificates registered by the BIML, 2014.06–2014.08
- 47 List of OIML Issuing Authorities
- 48 New Members, Committee Drafts received by the BIML, Calendar of OIML meetings



■ technique

- 5 Investigation et caractérisation du comportement des compteurs d'eau sous différentes conditions de débit
Gudrun Wendt

■ évolutions

- 15 Technologie pour les instruments de pesage totalisateurs utilisés pour recevoir et expédier des produits en vrac
Wolfgang Euler et Werner Braun
- 26 Le développement et la transformation de la législation nationale sur la métrologie en Ukraine
Oleh Velychko
- 32 Métrologie et globalisation
Ysabel Reyes Ponce

■ informations

- 38 Groupe de Travail ASEAN sur la métrologie légale
Manfred Kochsiek et C. Sanetra
- 41 Systèmes OIML: Certificats de Base et MAA enregistrés par le BIML, 2014.06–2014.08
- 47 Liste des Autorités de Délivrance OIML
- 48 Nouveaux Membres, Projets de Comité reçus par le BIML, Agenda des réunions OIML

■ Editorial



STEPHEN PATORAY
BIML DIRECTOR

Looking forward

In preparing this Editorial, I referred back to a number of previous Editorials, and notably the one written by CIML President Peter Mason which was published in the January 2014 Bulletin. In it, he expressed his optimism for the future of the OIML based on the completion of several projects and the rise in membership and interest in the OIML. While I most certainly do have a great sense of satisfaction concerning the completion of some major work projects at the BIML, such as:

- greatly improved teamwork within the BIML,
- markedly improved financial results for the Organization,
- completion of major renovation projects at the Bureau,
- completion of the updates on most OIML Basic Publications,
- implementation of OIML B 6 *Directives for Technical Work*,
- translation of a number of Recommendations, Documents, Basic Publications and minutes into the French language, and
- the launch of a new OIML IT system, website and database system

just to name a few, it is now the future work which lies ahead that really motivates me.

As I traveled to various meetings this past year and as I have spoken to CIML President Mason and to the BIML staff about their travels, I too sense an increasing interest and expectation from both our current and prospective Members. As the world continues to move towards more trade agreements, whether they are regional or international, there is an increasing need for the International Recommendations of the OIML to form at least a small part of these agreements.

However, to ensure that our Recommendations are relevant and that they are suitable for use in these agreements, they must all be regularly reviewed and kept current. As CIML President Mason pointed out, most of the resources for this work come from our Members. While several new Member States and a large number of Corresponding Members have joined our ranks over the recent years, with the economic challenges which have continued for some time, resources available for the OIML technical work are certainly not increasing. This is one major challenge we currently face and for which we must find solutions.

A second challenge lies in the OIML Certificate System, both the Basic and the MAA. A large amount of resources went into creating both systems. The MAA has now been in full operation for nearly ten years. Before the 2013 CIML meeting we held a seminar to discuss the MAA and possible areas for improvement. An ad hoc working group was formed which recently held its first meeting to discuss details of whether or how to improve the MAA. One key question we must answer is how to increase both the number of participants and also the acceptance and use of the MAA.

We now have a solid foundation in place, we have new tools and resources to call upon, we have a highly motivated team of professionals at the BIML. I for one am always ready to help solve any problems. From the encouraging feedback I have received from our Members as well as information from others, I believe that the OIML is also ready to continue working to solve these issues. Together with CIML President Mason, I too look forward with great optimism to the future of the OIML. ■

WATER METERS

Investigation and characterization of water meter behavior under different flow conditions

GU DRUN WENDT, Physikalisch-Technische Bundesanstalt (PTB), Braunschweig, Germany

Abstract

Using the advantages of optical, non-intrusive laser techniques, the influence of different flow conditions in front of and inside mechanical water meters on the meters' metrological behavior is studied. The investigations are focused on the comparison of three-dimensional velocity distributions measured by Laser Doppler Anemometers (LDA) with the corresponding water meter error curves at ideal and disturbed flow profiles and at different flowrates. The concrete technical solutions as well as the optimized LDA data processing and presentation are explained. Besides qualitative descriptions of flow patterns by means of various 2D and 3D diagrams, dimensionless parameters are defined to realize a quantitative characterization of the flows investigated with the aim of developing a model which allows the understanding of, and – if possible – the prediction of changes in the corresponding water meter readings.

1 Metrological background

Nearly all types of flowrate measuring devices installed in pipes are affected by the flow conditions at their inlet section. So-called disturbed velocity distributions of non-regular shape, with asymmetries or swirls can lead to meter errors on an unpredictable high level of several percent [1,2]. This statement also applies to water meters. Accordingly, the related OIML Recommendation R 49 [3] prescribes a special type approval test to guarantee that the readings of the water meters lie within the predicted maximum permissible error range also under disturbed inlet flow conditions, and an appropriate flow profile sensitivity class has to be specified for each water meter type.

In the past few years, great efforts have been made to find suitable methods to investigate the correlation between different pipe configurations, resulting flow distributions over the pipe's cross section and the corresponding metrological behavior of the meters installed behind it. In this connection, for example, bends, diameter changes or partly blocked pipe sections are considered as realistic pipe configurations to be investigated. In particular, methods enabling a close look directly into the flow at the meter's inlet section or inside the meter itself are of greatest interest in order to gain a better understanding of the processes leading to changes in the meter's behavior. The results should form the basis of a theoretical model which provides an explanation and – if possible – a prediction of the variations/errors in the corresponding flow meter readings observed.

2 Universal optical unit for flow velocity measurements in pipes

As a result of the successful cooperation between the Physikalisch-Technische Bundesanstalt (PTB) and two small spin-off enterprises (ILA Inc., Germany and OPTOLUTION Inc., Switzerland), an automated modular laser system has been developed which allows measurements to be made of three-dimensional velocity distributions in liquid pipe flows. The system comprises a traversable Laser Doppler Anemometer (LDA) consisting of an Nd:YAG laser and related optics, a universally adaptable window chamber, and special software [4].

The LDA technique as a contactless optical method measures the local velocity of a flowing fluid with high temporal and spatial resolution. In the present case, the individual measuring positions inside the pipe can be freely selected in advance and in any order. A special laser beam-backtracking software program calculates and activates the necessary traveling of the LDA unit, taking into account all changes in the laser beam due to refractive effects at the transit surfaces from air to glass and water. Figure 1 shows the experimental setup with a standard window chamber adapted to a straight pipe. In the lower right corner, the head of the traversable LDA unit is seen.

The window chamber enables optical access to the pipe section under investigation. Its special design and modular structure (Figure 2) offer a high degree of variability to ensure an optimum adaptation to the respective measuring situation. The outer connecting flanges, the inner glass tube and its adapter can be flexibly configured so that they provide an exact fitting to the surrounding pipe work. That way, additional

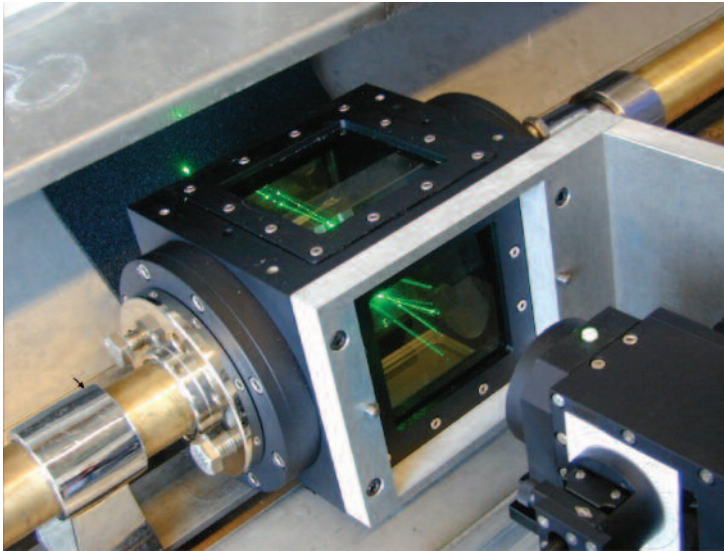

Figure 1 Experimental setup of a pipe configuration with window chamber and traversable LDA unit

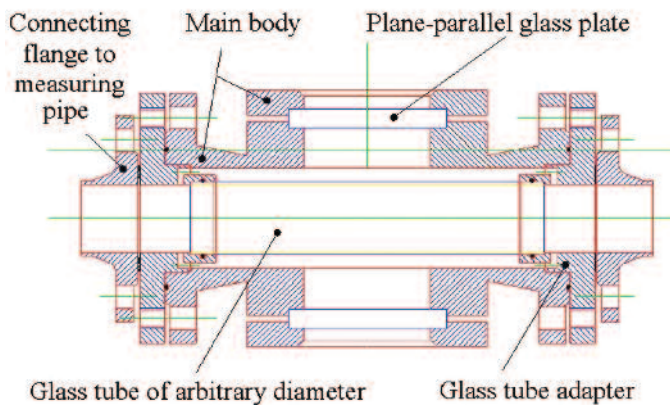

Figure 2 Construction details of the window chamber

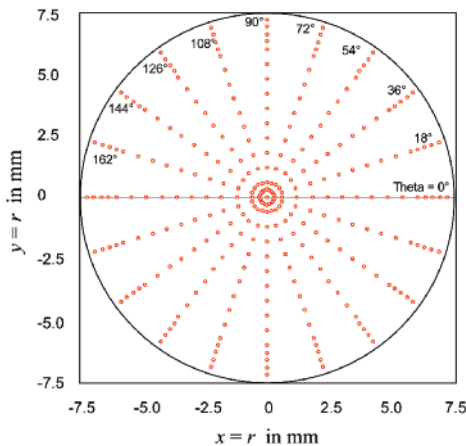

Figure 3 Measuring grid for a circular pipe cross section with a diameter of $d = 15$ mm

influences of the window chamber on the flow under test are minimized. The main body is water filled. The critical transit of the laser beams from air to glass and water takes place on the surface of a plane-parallel glass plate. This, altogether, essentially reduces possible refraction effects and guarantees the proper operation of the laser beam-backtracking system.

The laser Doppler anemometry is a punctual method. It provides the local flow velocity only within the point of intersection of the laser beams and only for the velocity component perpendicular to the crossing plane of the beams. To obtain information on the complete three-dimensional velocity distribution over the whole pipe cross section, two separate work steps have to be carried out:

- Depending on the desired resolution of the velocity field under investigation (i.e. on the density of the individual measuring points across the pipe cross section), the LDA unit should be moved successively from one measuring position to the next. Figure 3 shows the grid tailored for the current investigation. Altogether, it consists of 301 individual measuring points located along 15 concentric circles around the center point with an angular distance of 18° each. Regarding the higher velocity gradient expected towards the pipe wall, the density of points is increased in this region.
- The measurement of all three components of each velocity vector requires three different orientations of the laser unit. In the present case, this is achieved by using the LDA unit horizontally in two orientations where only its head is rotated by 90° . Afterwards the complete laser unit is moved to an upright position to obtain the third component.

After completing all the measurements, the data of each measuring point are merged and prepared for further interpretation and evaluation. The related software provides several options to present the measured values, for example, in the form of:

- spatial diagrams of the axial velocity distribution in m/s or normalized to the mean volumetric velocity $w_{vol} = Q_V / (\pi \cdot r^2)$ – see Figure 4 for an undisturbed turbulent flow after a long straight pipe,
- diagrams of the tangential velocity distribution, where the lengths of the arrows are normalized to the mean volumetric (axial) velocity; the colors represent the corresponding swirl angles – see Figure 5 for a swirl-afflicted flow behind a swirl generator,
- diagrams of the degree of turbulence in percent – see Figure 6 for an undisturbed flow, and
- single velocity profiles and degrees of turbulence along each diameter of the measuring grid – see Figure 7 for an asymmetric flow behind a swirl generator.

3 Measuring programs and experimental goals

Using the LDA techniques described above, velocity distributions in liquid flows were determined for a wide field of conditions, for instance:

- at flowrates between 60 L/h and 120 m³/h;
- in pipes with diameters between 5 mm and 300 mm;
- at temperatures between 10 °C and 50 °C;
- under “ideal” undisturbed flow conditions (after straight pipes of various lengths); and
- behind diverse disturbing pipe elements (elbows, constrictions, diffusers), standard disturbers (swirl generators, diaphragms, plates partly blocking the pipe cross section), and flow straighteners or conditioners (perforated plates, meshes, etc.).

To obtain information about the corresponding behavior of the water meters, all their error curves had been determined under exactly the same “disturbed” flow conditions as was used for the LDA investigations. Two aims are to be emphasized: the reduction in the necessary number of further investigations because of the possibility of taking advantage of similarity effects, and the identification of limits and parameter fields where the flow disturbances do not significantly affect the flow meter behavior.

However, for this purpose the graphic representations of Figures 4–7 are not entirely sufficient – they present only qualitative pictures of the flow and the processes running inside. Therefore, the determination of special parameters describing a certain flow quantitatively proves beneficial.

4 Definition of dimensionless flow-characterizing parameters

Altogether, four dimensionless parameters have been determined to completely characterize each kind of flow developing inside circular pipes. The axial velocity components are estimated by three parameters describing the shape of the profile, its symmetry and the degree of turbulence. A fourth parameter – the swirl angle – was defined to provide further information on tangential velocity components.

A detailed description of the definition and interpretation of the following parameters as well as a great amount of concrete examples are given in [5,6].

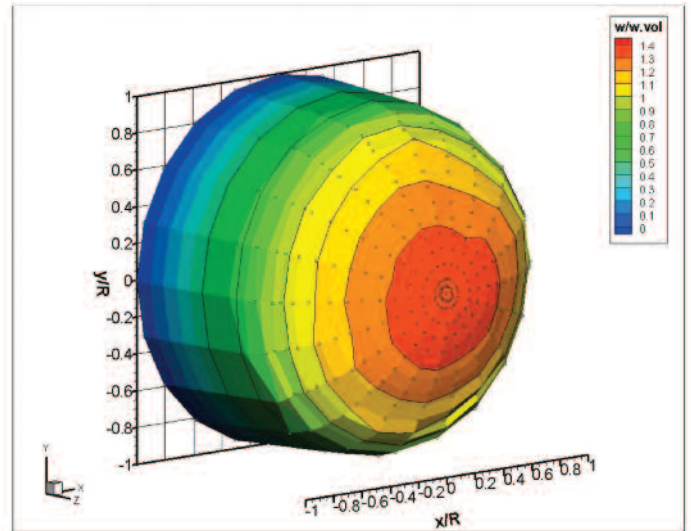

Figure 4 Normalized axial velocity distribution for an undisturbed turbulent flow; pipe diameter $d = 15$ mm, length of the straight inlet pipe $l = 50 d$, flowrate $Q_{vol} = 600$ L/h

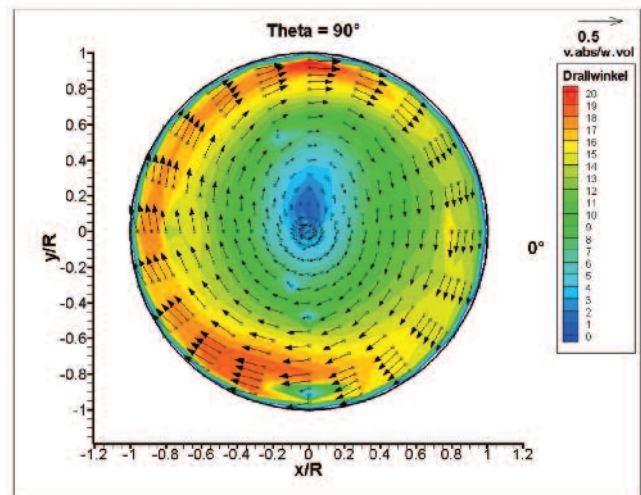

Figure 5 Normalized tangential velocity distribution for swirl-affected flow behind a swirl generator; pipe diameter $d = 15$ mm, distance between swirl generator and measuring section $l = 5 d$, flowrate $Q_v = 600$ L/h

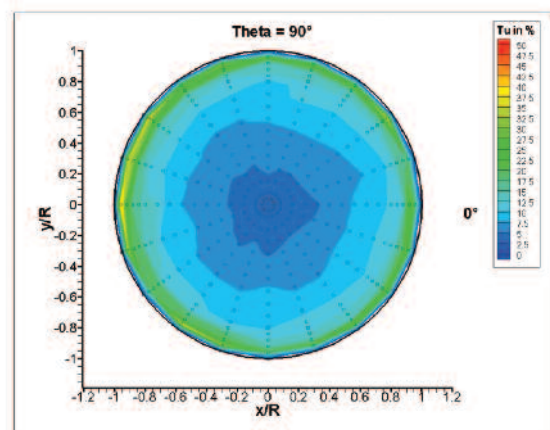

Figure 6 Percentage degree of turbulence Tu ; pipe diameter $d = 15$ mm, length of the straight inlet pipe $l = 50 d$, flowrate $Q_v = 1\,200$ L/h

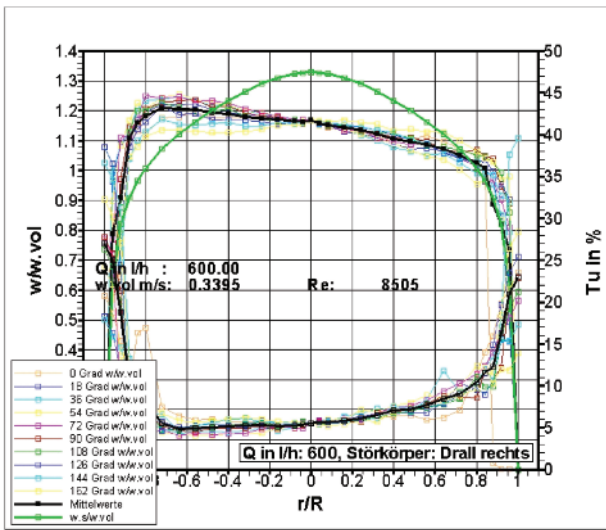

Figure 7 Normalized velocity profiles along the 10 diameters of the measuring grid (black line = their average) compared with the theoretical velocity profile of a fully developed turbulent flow (green line); pipe diameter $d = 15$ mm, distance between swirl generator and measuring section $l = 5 d$, flowrate $Q_v = 600$ L/h

4.1 Profile factor K_p

The profile factor K_p compares the shape of the profile measured $K_{p,meas}$ with the ideal profile $K_{p,s}$ of a fully developed laminar or turbulent flow:

$$K_p = \frac{K_{p,meas}}{K_{p,s}} = \frac{\int (w_m - w) dr}{\int (w_{m,s} - w_s) dr} \quad (1)$$

where w_m is the velocity at the pipe centre $r/R=0$
 w is the local velocity at r/R
 index s stands in relation to the ideal ("standard") profile.

The profile factor provides information on the flatness ($K_p < 1$) or peakedness ($K_p > 1$) of the profile. In the case of a fully developed flow, the profile factor takes the value 1. The ideal ("standard") profiles were

- the HAGEN-POISEUILLE profile for laminar flows, and
- the GERSTEN & HERWIG profile [7,8] for turbulent flows.

4.2 Asymmetry factor K_a

The asymmetry factor K_a represents the displacement of the center of the area away from the rotation symmetry line:

$$K_a = \frac{\int_0^1 r \cdot w \cdot d\left(\frac{r}{R}\right)}{2 \cdot R \cdot \int_0^1 w \cdot d\left(\frac{r}{R}\right)} \quad \text{in } \% \quad (2)$$

4.3 Turbulence factor K_{tu}

The turbulence factor K_{tu} characterizes the velocity fluctuations of the flow to be investigated. It is defined as the ratio of the maximum degree of turbulence Tu_{max} within the core area of the flow between $-0.2 \leq r/R \leq 0.2$ and the degree of turbulence of the corresponding fully developed (ideal) flow Tu_s (according to [9]):

$$K_{tu} = \frac{Tu_{max} \Big|_{\substack{r/R = -0.2 \\ r/R = 0.2}}}{Tu_s} \quad (3)$$

$$Tu = \frac{s}{w} \quad \text{in } \% \quad (4)$$

$$Tu_s = 0.13 \cdot \left[\text{Re} \left(\frac{w_m}{w_{vol}} \right) \right]_s^{\frac{1}{8}} \quad (5)$$

where s is the standard deviation of w
 \bar{w} is the mean velocity over the measuring time Δt
 w_{vol} is the mean velocity derived from the actual volume flowrate

4.4 Swirl angle Φ

Beside the three flow-characterizing parameters based upon the axial velocity components of the flow, the swirl angle Φ was defined by using information from the tangential velocity components:

$$\Phi = \arctan \left(\frac{v}{w_{vol}} \right) \quad (6)$$

where v is the tangential component of the velocity vector in the measuring point observed.

4.5 Acceptance criteria

After defining these parameters and testing their suitability, corresponding automatic calculations were included in the data evaluation software of the LDA system. Analyzing and discussing the results of more than a hundred diverse flow measurements and considering the corresponding (situation-dependent) flow meter readings, concrete quantitative limits for the four flow parameters could be found. Thus, if flow parameters measured at the inlet section of a flow meter

meet the acceptance criteria listed in Table 1, it can be expected that the flow meter is not significantly affected by the incoming flow conditions.

If only one parameter does not match the criteria, measures should be taken to avoid possible changes in the meter's behavior due to disturbances in the flow. The concrete values of the parameters provide a good orientation as to what could be done to improve the flow conditions, for example, by extending the straight pipe in front of the meter, or by inserting special flow conditioners or straighteners into the meter's inlet pipe.

5 Extension of the investigations of multi-jet cartridge water meters

5.1 Technical realization

In most of the cases, the study of the flow conditions within the pipe sections only in front of a flow meter does not yet completely explain the meter's reaction resulting in unpredictable unwanted changes in its reading. Consequently, the investigation had to be continued by modifying the LDA system to gain access to the internal flow areas of the meter and to directly study the respective flow processes depending on the concrete flow meter construction.

Due to a current source of interest, it was decided to start such investigations with small co-axial multi-jet water meters [10] consisting of a measuring cartridge attachable to the corresponding pipe section by screwing it into an appropriate meter housing (see Figure 8). This housing remains in the pipe, i.e. it becomes a permanent part of the general domestic water installation all of the time. Necessary metrological and legal activities are limited to the cartridge. All tests and, in particular, the verifications are made by not using the original housing but only a specimen; the required replacing of a water meter after expiry of the verification date applies only to the cartridge. On the other hand, each meter housing forms a part of the measuring volume and, in that way, can exert noticeable influence on the measuring behavior of the meter. Due to the lack of any theoretical or experimental data, serious doubts had been expressed as to whether a cartridge meter could be considered as a water meter in the sense of the new European Measuring Instruments Directive (MID) [11] – thus, a real need for action arose.

The most interesting area of investigation inside such a multi-jet cartridge water meter is the concentric ring gap inside the housing where the horizontally incoming water changes its direction and enters the cartridge vertically. To ensure optical access even to this region, the window chamber of the LDA system, as well

Table 1 Acceptance criteria for the flow parameters

Profile factor K_p	Range	$0.8 \leq K_p \leq 1.3$
Asymmetry factor K_a	Maximum value	$K_a \leq 1\%$
Turbulence factor K_{tu}	Maximum value	$K_{tu} \leq 2$
Swirl angle ϕ	Maximum value	$\phi \leq 2^\circ$

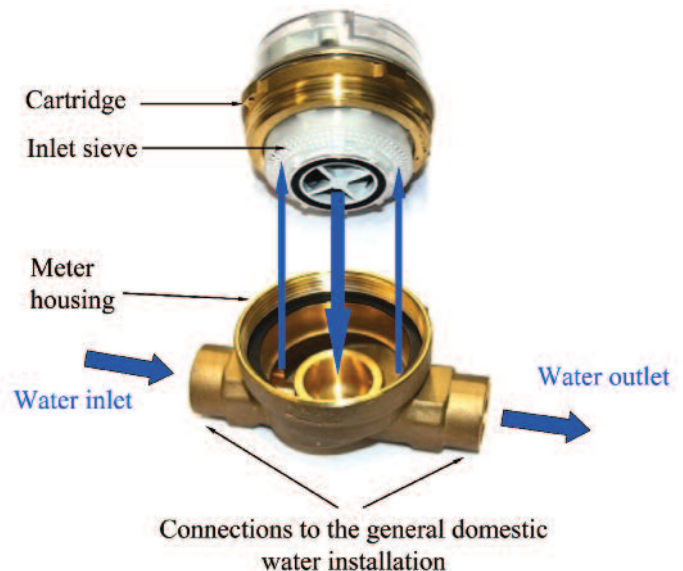

Figure 8 General principle of a multi-jet cartridge water meter

as the water meter, had to be adapted to the new measuring situation. The cartridge was completely replaced by special glass tubes exactly simulating the real water flow through the cartridge (see Figure 9).

5.2 Adaptation of the LDA system

In addition to the modifications of the water meter, the window chamber as well as the software of the LDA system had to be adapted. Now the upper cover of the window chamber has to hold a special flange which diverts the flow from the outer ring gap into the inner water meter outlet. Thus, the third measuring position that requires changes in the construction of the chamber is lacking. The new solution (see Figure 10) allows optical access to the measuring area merely by moving the LDA unit in the horizontal plane from window to window and by rotating it around its own axis.

The measuring grid was also changed: six circles of 72 measuring points each are arranged inside the ring gap (see Figure 11), the width of which amounts to 6 mm in the present case of water meters for nominal pipe diameters of 15 mm. So, altogether, each velocity distribution to be measured consists of 432 single measuring points.

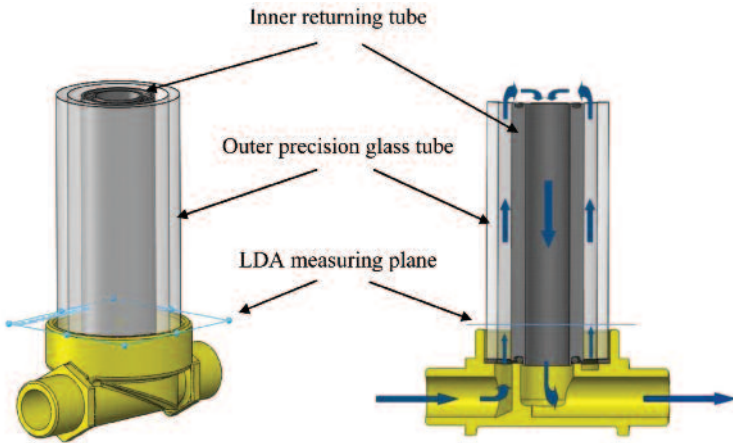

Figure 9 Modification of the multi-jet cartridge water meter to provide optical access to the area of interest inside the meter.

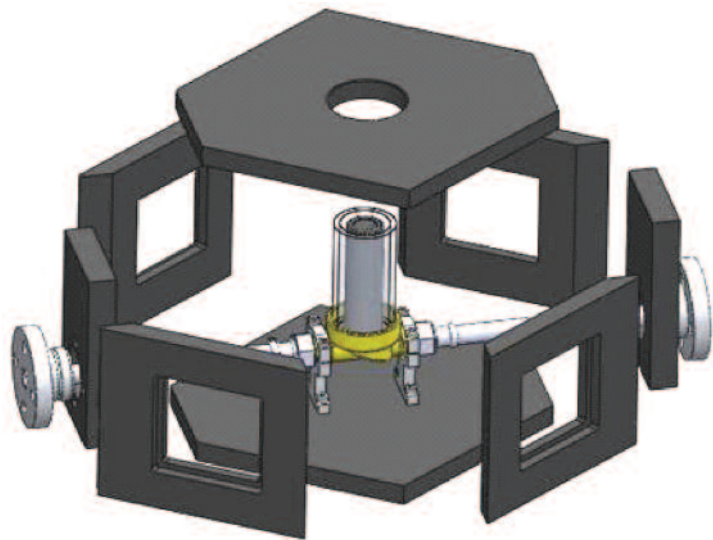

Figure 10 New construction of the window chamber allowing optical access to the LDA measuring plane inside the water meter according to Figure 9

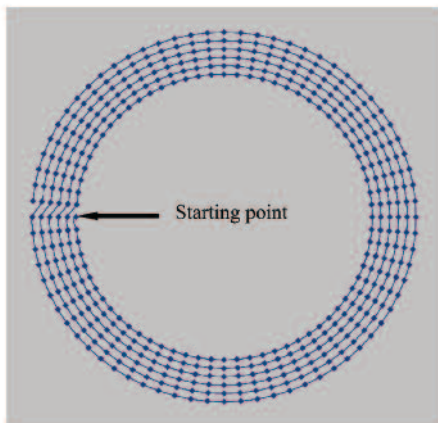

Figure 11 Measuring grid modified to measure velocity distributions inside the ring gap of a multi-jet cartridge water meter

The data processing and evaluation were modified, as well. Figure 12 shows an example of a distribution of the axial velocity component inside the ring gap (top view). Here, the incoming flow is completely unaffected by any disturbance. It enters the meter housing horizontally from the left, splits and circulates through the lower ring channel, turns in the upright direction and then moves towards the observer.

5.3 Definition of a further dimensionless flow-characterizing parameter

Also in the case of the cartridge meter investigations, the LDA measurements were carried out for a very wide range of different flow conditions and configurations which resulted in a great amount of qualitative descriptions of the corresponding velocity distributions in the form of Figure 12¹⁾ – and again the question of how to make them intercomparable arose.

Due to the specific construction of the cartridge, a minimum effect on its functionality can be expected when the flow is relatively “even” and rotation-symmetrically arranged over the whole ring gap. In that case, the wheel inside the cartridge will be driven continuously and uniformly, and the reading of the water meter should be highly reproducible. Therefore the aim was to find a parameter characterizing such an “ideal” velocity distribution – the so-called “homogeneity factor”.

Figure 13 presents, in the first instance and in correspondence with the flow conditions of Figure 12, the primary data of a complete scan consisting of $i = 1 \dots 432$ axial velocity values which are listed in the order of their determination. The horizontal red line specifies the mean volumetric velocity w_{vol} ; at a flowrate of 600 L/h it amounts to 0.227 m/s. Negative velocity values imply a reversing flow at the corresponding measuring points.

When looking for a suitable definition of the homogeneity factor, the quantity of the flowing liquid will be of essential interest, but not its velocity. Therefore, an additional fact has to be taken into account: depending on the radial position of a measuring point, its velocity value will represent different portions of the total flow due to different sizes of the corresponding elemental areas. Consequently, each velocity value has to be multiplied by an

¹⁾ It could be shown that in the present case the analysis of the axial velocity components is quite sufficient for a comprehensible evaluation of the relationship between incoming flow conditions and the following water meter reaction.

appropriate weighing factor, increasing from inside to out. Moreover, a better impression of the active distribution of the flow across the ring gap will be reached looking at the mean values of the radial sectors around the gap. Figure 14 shows the final diagram of the weighted normalized sectoral mean $z_{mean,j}$ along each traverse j inside the ring gap depending on their angular position, starting at the water inlet on the left and moving anti-clockwise around the ring gap. In accordance with the given measuring grid (see Figure 11), the angular distance amounts to 5° .

The desired, preferably uniform flow distribution across the ring gap requires that the normalized means of Figure 14 are as close as possible to the red line at $z_{mean} = 1$. Therefore, the homogeneity factor F_h can be defined as:

$$F_h = \frac{1}{72} \cdot \sum_{j=1}^{72} |z_{mean,j} - 1| \quad (7)$$

In the present example, F_h amounts to 0.63. In general, it can take a value between 0 and 1:

- $F_h = 0$ represents the case of a completely uniform flow distribution at the mean velocity level;
- $F_h = 1$ stands for an exactly 50 % blockage of the ring gap (See Figure 15).

5.4 Measured values

In real situations, the inlet of a cartridge is protected by using sieves of several designs (see, for instance, Figure 8). Thus, each incoming flow has to pass these sieves before it moves upwards through the gap. Due to the standardized construction of the water meters [10], the sieves are normally positioned inside the lower part of the housing still beneath the LDA measuring level.

Figure 16 shows an example of a ring gap flow when a sieve is put into the lower part of the housing which simulates the real case where a cartridge would be screwed in. The corresponding homogeneity factor amounts to 0.164.

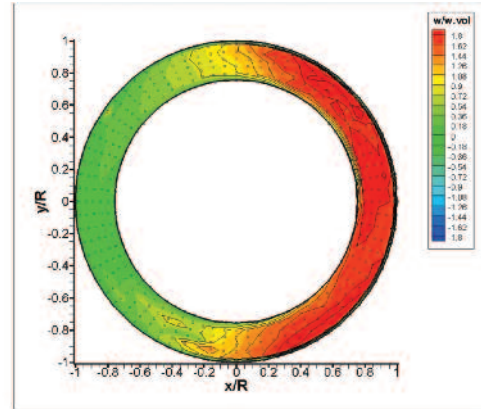

Figure 12 Distribution of the axial velocity component of an undisturbed incoming flow inside the ring gap of a multi-jet cartridge water meter for a flowrate $Q_v = 600$ L/h

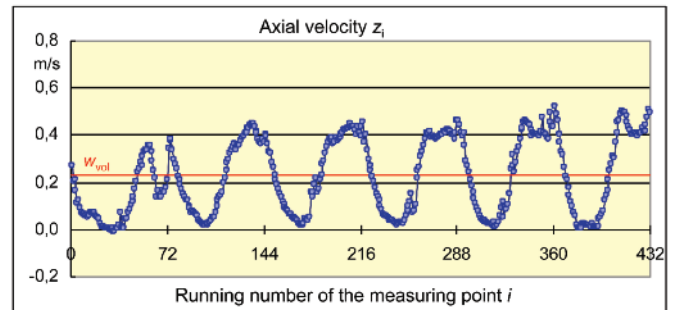

Figure 13 Axial velocity in m/s inside the ring gap in the order of its determination

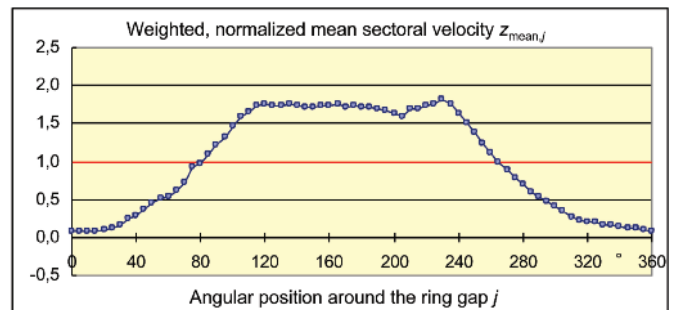

Figure 14 Weighted, normalized sectoral mean of the axial velocity components along each of the 72 traverses inside the ring gap

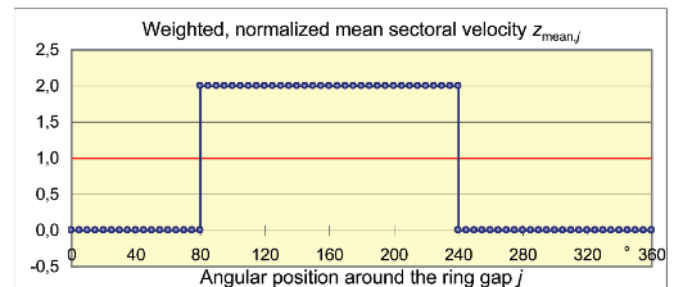

Figure 15 Weighted, normalized sectoral mean of the axial velocity components along each of the 72 traverses inside the ring gap in the case of a complete 50 % blockage of the ring gap

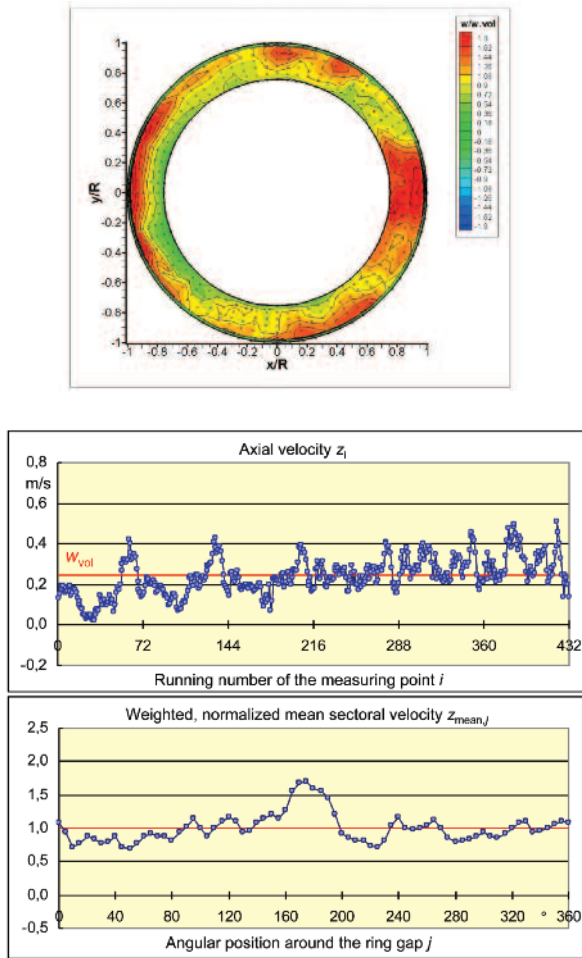

Figure 16 Axial velocity distribution and its numerical decomposition in accordance with figures 12 through 14; flowrate $Q_v = 600$ L/h through a multi-jet cartridge water meter housing equipped with a sieve

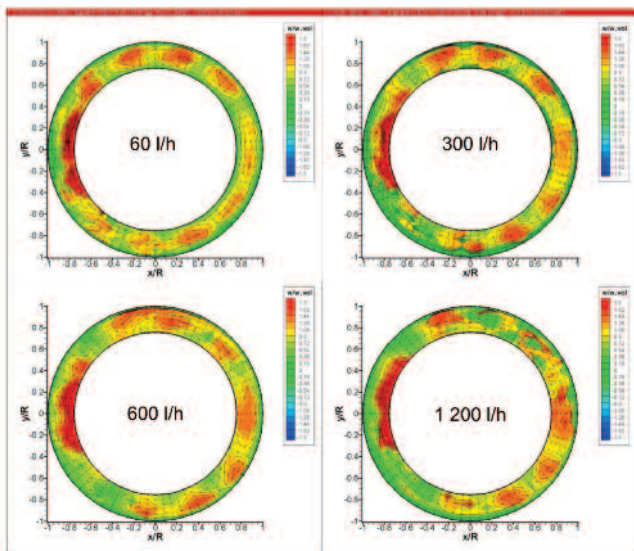

Figure 17 Axial velocity distributions in the ring gap of a multi-jet cartridge water meter after a sieve was put into the lower part of the meter housing to simulate a real cartridge inlet; flowrates between 60 L/h and 1200 L/h

The (in-)dependence of such a gap flow on the flowrate can be demonstrated by the presentations given in Figure 17. The flowrates vary between 30 L/h and 1200 L/h without changes in the measuring installation. The diagrams look quite similar.

The respective homogeneity factors amount to

- 0.229 at 60 L/h,
- 0.206 at 300 L/h,
- 0.245 at 600 L/h,
- 0.247 at 1200 L/h.

Further investigations using other sieve designs yielded similar results.

Altogether, more than 30 different measuring arrangements of 15 mm multi-jet cartridge water meters were investigated:

- under “ideal” undisturbed flow conditions (after straight pipes of various lengths);
- behind several disturbing pipe elements (elbows) and standard disturbers (swirl generators); and
- under conditions simulating strong contaminations and accumulated dirt and soil by partly sealing the sieves (see Figure 18) and the ring-shaped blocking of the inlet pipe section by up to 50 %.

For all the measuring situations investigated, the corresponding error curves of the complete cartridge meters were determined as well. So it was again possible to look for a correlation between the flow conditions in front of or inside the cartridge meter and its metrological behavior (See Figure 19).

It was possible to obtain valuable findings concerning the relationship between a concrete pipe configuration, the resulting homogeneity factor and the corresponding change in the water meter’s error curve. The homogeneity factors K_h amount to:

- 0.1 ... 0.3 for all configurations with a sieve and non-blocked meter inlet (but with disturbers and contaminated sieves),
- 0.3 ... 0.5 for all configurations with a sieve and a 50 % blocked meter inlet, and
- 0.5 ... 0.8 for all configurations without a sieve.

The error curves of the completed cartridge meters had been significantly affected only in one situation – in the case of the absence of any sieves, i.e. when the homogeneity factor is greater than 0.5. Due to the fact that all cartridge water meters possess protecting means at their inlet section and that the dimensions of the “interface” between cartridge and housing are internationally standardized [10], it can be expected that correctly installed and maintained multi-jet cartridge water meters can be treated as water meters also in accordance with the MID [11].

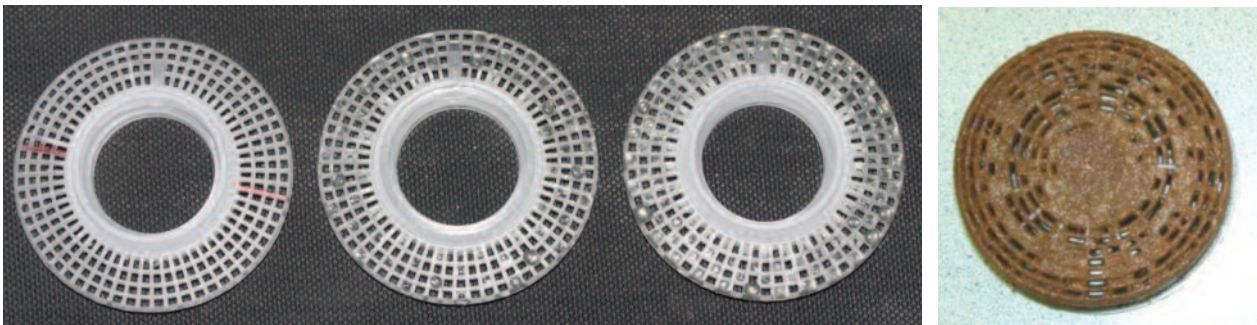

Figure 18 Inlet sieves of a multi-jet cartridge water meter.
 From left to right: Clean sieve without any dirt; sieves with blocked gaps (opening degrees of 75 % and 50 %) to simulate fouling during usage and a “normally” contaminated sieve after some years in a regular house installation

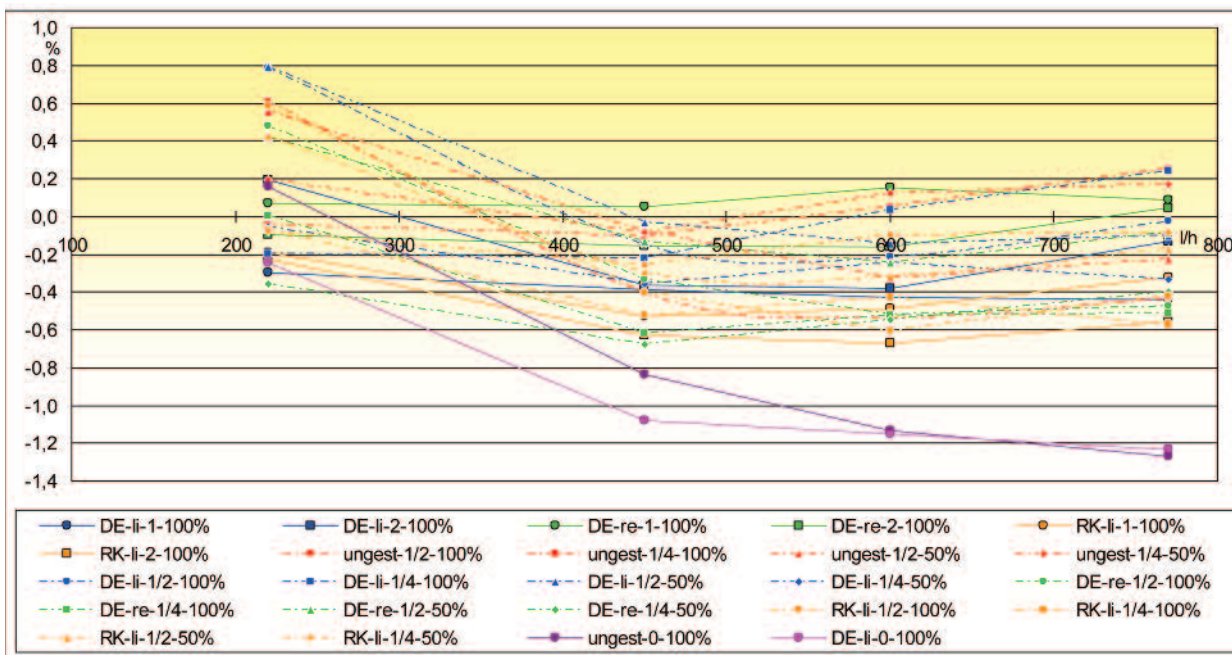

Figure 19 Selected deviations of the water meter readings from the respective undisturbed case depending on the flowrate (220 L/h ... 780 L/h)

Explanation of the error curves' marking:

DE standardized swirl generator according to [3]
 RK double bend out of plane
 ungest undisturbed
 li left-hand orientated swirl
 re right-hand orientated swirl
 0 without sieve

1 meter type 1
 2 meter type 2
 1/2 blockage of inlet sieve of 50 %
 1/4 blockage of inlet sieve of 25 %
 100 % completely open inlet section in front of the meter
 50 % ring-shaped blockage of the inlet pipe section in front of the meter by 50 % of the cross section

6 Conclusions

- Laser optical methods allow studies of flow conditions in pipes as well as inside flowrate measuring devices.
- It is possible to define dimensionless parameters characterizing the flow under several metrologically interesting aspects.
- It is possible to find acceptance criteria of these parameters providing a “non-disturbed”, i.e. a not significantly changed, behavior of a flowrate measuring device.

Acknowledgements

The author would like to thank Dr. Ulrich Müller (OPTOLUTION Inc., Switzerland) and Dr. Michael Dues (ILA Inc., Germany) for their continuous, highly competent support during each stage of applying and modifying the LDA unit. Thanks are also expressed to Andreas Hein, Torsten Jahn and Ulrich Jakubczyk for their careful, exact and diligent completion of the comprehensive experimental and technical work. ■

7 References

- [1] Adunka, F.: *Installation effects at water and heat meters*. Proc. 2nd Middle-East Conference Bahrain, 2004
- [2] Wendt, G.: *Einfluss des Strömungsprofils auf das Messverhalten von Wasser- und Wärmemessern*. PTB-Bericht PTB-MA-79, 2007, pp. 25-41
- [3] OIML R 49 (2013) *Water meters for cold potable water and hot water*. Part 1: Metrological and technical requirements. Part 2: Test methods. Part 3: Test report format.
- [4] Lederer, T.; Wendt, G.; Matthies, P. N.; Többen, H.; Müller, U.; Dues, M.: *Verfahren zur Messung von Geschwindigkeitsverteilungen eines durch einen Rohrquerschnitt strömenden Fluids und Messanordnung zur Durchführung des Verfahrens*. German Patent No. 10 2006 039 489
- [5] Müller, U.; Dues, M.; Wendt, G.; Rose, J.; Baumann, H.: *Richtlinie zur strömungstechnischen Validierung von Kalibrier-Prüfständen im Rahmen der EN 1434*. Richtlinie der AG Laseroptische Strömungsmesstechnik, PTB Berlin, 2006
- [6] Dues, M.; Müller, U.: *Messtechnische Erfassung des Strömungsprofils – Kennzahlen zur Charakterisierung der Strömungsbedingungen*. PTB-Bericht PTB-MA-79, 2006, pp. 43-74
- [7] Gersten, K.; Herwig, G.: *Strömungsmechanik. Grundlagen der Impuls-, Wärme- und Stoffübertragung aus asymptotischer Sicht*. Braunschweig Wiesbaden: Vieweg-Verlag, 1992
- [8] Gersten, K.: 2005 *Fully developed turbulent pipe flow*. In: Fluid mechanics of flow metering. Editor: W. Merzkirch, Springer-Verlag Berlin Heidelberg New York, 2005
- [9] Durst, F.; Fischer, M.; Jovanovic, J.; Kikura, H.: *Methods to set up and investigate low Reynolds number, fully developed turbulent plane channel flows*. J. Fluids Eng. **120** (1998), pp. 496-503
- [10] European Standard EN 14154: 2005 + A2:2011 *Water meters*
- [11] Directive 2014/32/EU of the European Parliament and of the Council of 26 February 2014 on the harmonisation of the laws of the Member States relating to the making available on the market of measuring instruments (recast)

HISTORY OF WEIGHING

Part 12: Technology for totalizing weighing instruments used for receiving (unloading) and shipping (loading) loose bulk products

WOLFGANG EULER, HENNEF/SIEG – COLOGNE/BONN and
WERNER BRAUN, BALINGEN/ZOLLERNALBKREIS

In Part 11, we explained what bulk products are. Since cereals and rice have been the most important staple for thousands of years, we will deal in more detail with these bulk products – as well as with their treatment and processing. This field is covered by OIML R 107 *Discontinuous totalizing automatic weighing instruments (totalizing hopper weighers)*.

1 and 2 Grain and agribulk terminals

Figure 1 shows the receiving (unloading) process in front of the silo facility of the J. Müller Corporation – AGRI Gruppe – Brake, Unterweser (Germany). Here, Canadian cereals are just being unloaded from a large overseas cargo ship. The cereals are transported to the storage silos which can be seen in the picture, and are stored there temporarily. The cereals are unloaded by means of the lifter, with the help of suction units or mechanical units and via a discontinuous totalizing automatic weighing instrument (in the following abbreviated to “TAWI”)¹ which is located in the tower which can be seen in the picture, and then via drag chain conveyers and elevators. In nearly all silo facilities all over the world, the functional processes are quite similar to those described here, no matter whether the storage facilities are large or small, or whether they are used for silos in which cereals are stored at harvest time, or whether they are used for cereal and agricultural

¹ The totalizing automatic weighing instruments (TAWIs) used here are presented and described in the magazine *Mühle + Mischfutter*, No. 18, September 2013, p. 582 ff, and in the OIML Bulletin, No. 1, January 2014, p. 17 ff.

terminals all over the globe. Figure 2 (bottom left) shows the unloading of a bulk product; the bottom right picture shows the upper part of an elevator.

3 Technological process and the handling of loose bulk products in a mill (using cereals and flour as examples)

The handling process for loose bulk products is described in Figure 3 on the following page.

4 Constructional principle of totalizing automatic weighing instruments according to OIML R 107

The constructional principle is illustrated in Figure 4. Discontinuous totalizing automatic weighing instruments (totalizing hopper weighers) are used to weigh the mass of a bulk product. The mass depends on the flow of the product and varies from one weighing operation to the next. Such bulk weighers are used,

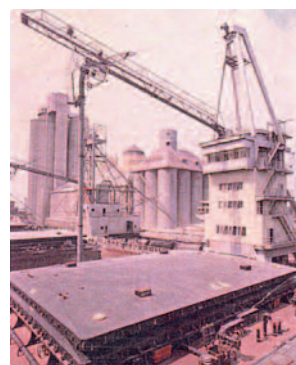

Figure 1 J. Müller Corporation - AGRI Gruppe - Brake, Unterweser (Germany)



Figure 2 Grain and agribulk terminals

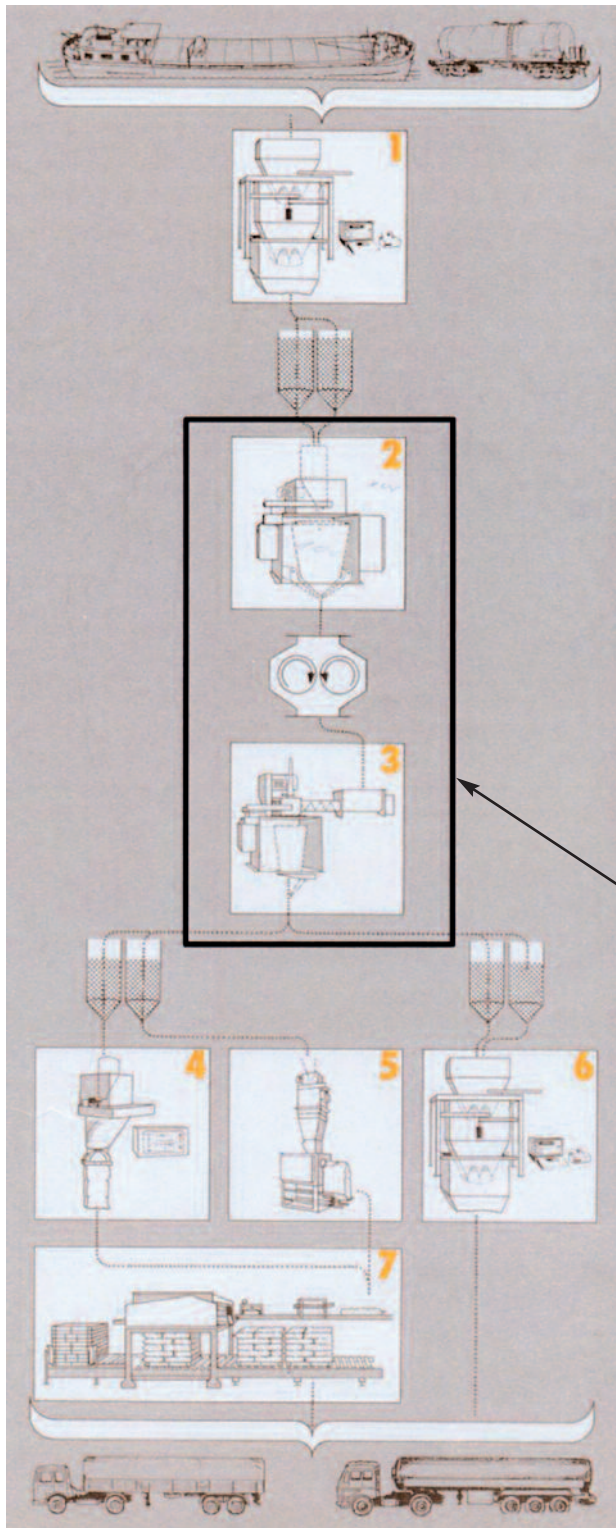
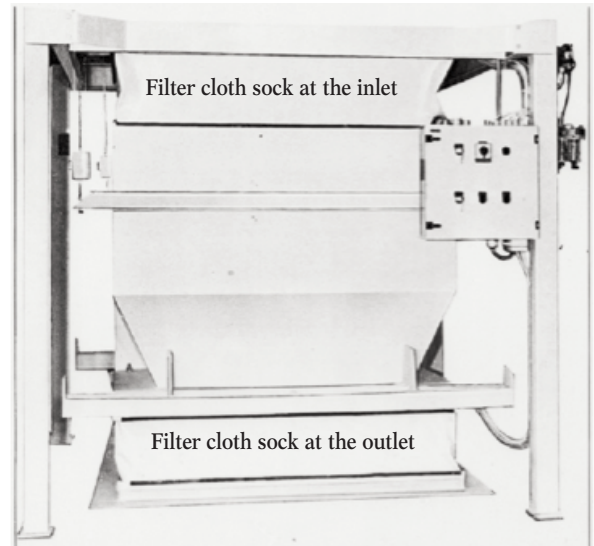
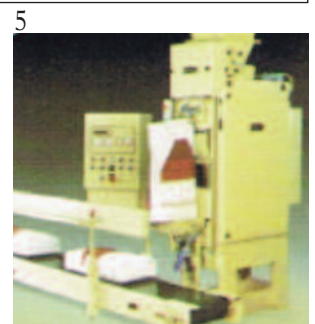

Figure 3 Handling process for loose bulk products

(1) Weighing instrument for unloading cereals from 750 kg to 10 000 kg. This receiving weighing instrument is a so-called “open weighing system”. This means that the weighing hopper (which is also called the “load receptor”) is located between the inlet and the outlet. What is important is that the inlet and the outlet must be of the same size (the reason for this is explained below).



Inside the black frame:
 The mill extraction system: These scales are usually not subject to approval.
 (2) Weighing instrument leading to the first milling breaker. Processes 100 % of the cereal input.
 (3) Usually, several weighing instruments are located here, e.g. for different types of flour, bran and impurities.



Bagging of different types of flour:

- (4) Open bags
- (5) Valve bags
- (6) Flour shipping weigher, principle as described in 1
- (7) Palletizing facility

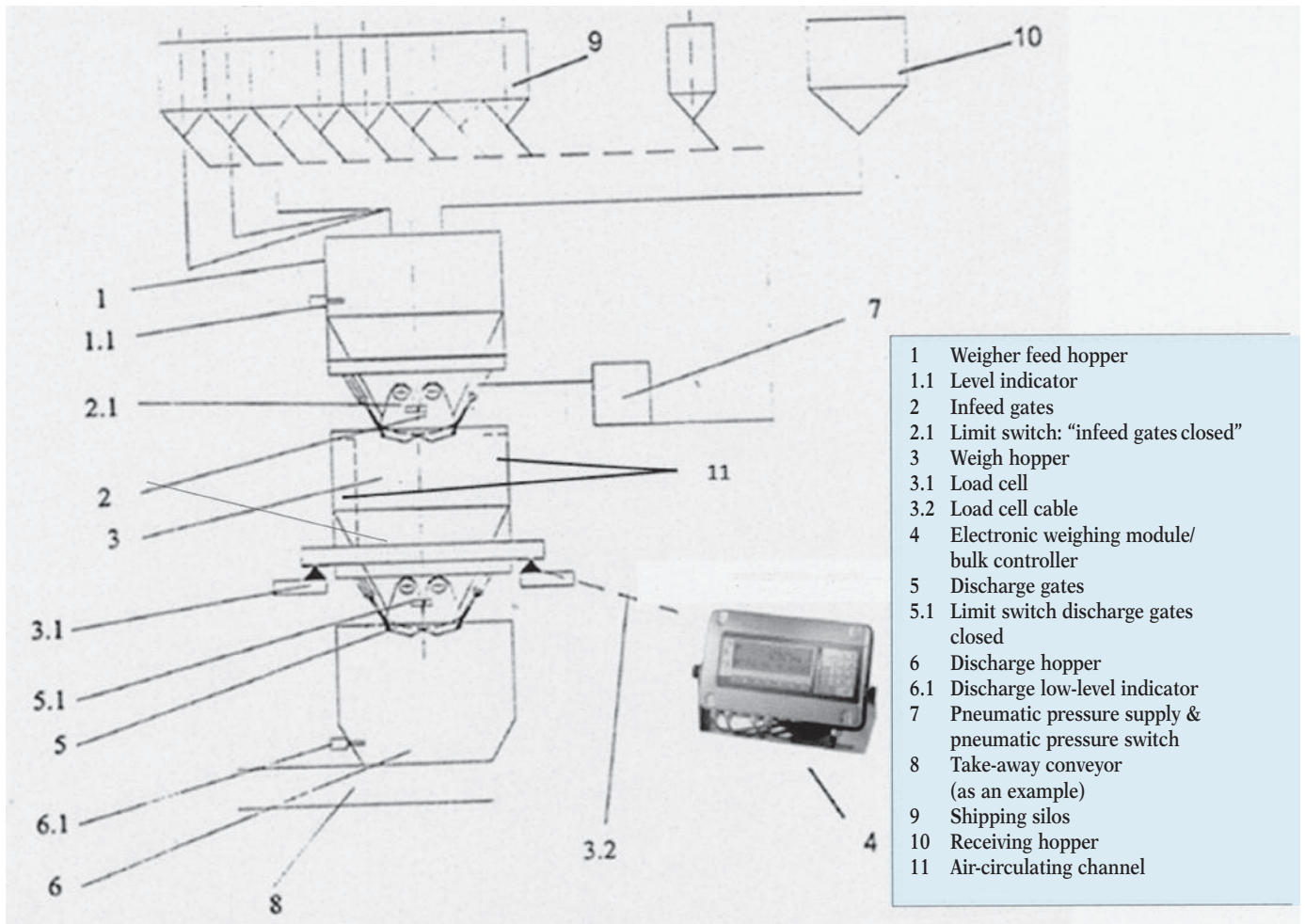

Figure 4 Constructional principle of totalizing automatic weighing instruments according to OIML R 107

for example, as weighing instruments for the loading and unloading of lorries and ships transporting products which are sold in loose or bulk form such as cereals, rice, flour, concentrated feed (raw materials), etc.

If bulk is to be unloaded, the infeed gates (2) open after the automatic hopper weigher has been started. If, on the other hand, a ship or a vehicle is to be loaded with bulk directly from one of the shipping silos (cylinders), then the level indicator (1.1) must show – before the infeed gates open – that there is a sufficient quantity of the product in store (this must be sufficient for two to three weighings).

If a ship or a vehicle is to be loaded with bulk directly from the silo, a quantity indicator for the silo is not required. The different quantities of bulk still pouring down from the various shipping silos to the "bulk weighing system – weigh hopper" after the loading process has finished are set up in the parameters of the electronic, totalizing weighing system *Bulk controller*

(4). Using this method, exact loading masses are achieved, as the different slide gates of the silo close as soon as the respective quantity of bulk has been reached. In this way, the transport paths between the shipping silos and the bulk weigher run until they are empty. If the next product is the same, there is no empty transport.

After the infeed gates (2) have opened, the bulk product is fed into the weigh hopper (3). The measurement signal of the load cells (3.1/3.2) is transmitted to the bulk controller (4).

During the filling process, the bulk product is separated into the three different categories: coarse, medium (if available) and fine by means of the bulk controller until the declared mass is reached. In the loading/unloading mode, the bulk controller (4) constantly operates with the infeed gates fully open (2). The classification into coarse, medium and fine takes place only during the last two weighings (depending on

the configuration), in order to achieve as exact a loading mass as possible.

When the declared target mass has been reached, the infeed gates close. The information that the infeed gates are closed is given by a sensor (electronic limit switch 2.1). During the time the weighing instrument is stabilizing, a setting-down time begins, after which the automatic stability detector is queried (stability over 1, 2 or 3 totalization scale intervals (d_t) during two to three measuring cycles). When the bulk weigh hopper is fully stabilized, the value of the full weighing instrument is either recorded (in the case of back-weighing) or (in the case of discharge weighing) tared (by subtraction).

What is determined is therefore the actual mass of the bulk product that has been applied to the load receptor (i.e. to the weighing hopper) of the weighing instrument. The actual mass is determined by continuous addition (totalizing) of the results of as many single weighings as desired.

After the mass value has been totalized, the discharge low-level indicator (6.1) in the discharge hopper (6) is queried. This discharge low-level indicator is positioned in such a way that it is ensured that the discharge hopper can accommodate at least one full weighing at the maximum capacity of the weighing instrument. If the silo indicator displays "OK for emptying", the discharge gates (5) open. The closing of the discharge gates is initiated depending on the mass. This means that the discharge gates (5) close when an adjustable mass value in the lower weighing range has not been reached, plus an additional safety time. The information that the gates are closed is given by a sensor (electronic limit switch 5.1). The product is removed by, for example, a take-away conveyor (8), a drag-chain conveyor or an elevator.

Weighing instruments for loading and unloading ships and vehicles are provided with a pneumatic pressure controller and with a reserve tank for compressed air (7). If creep or an abrupt drop in the compressed air occurs, this is detected by the pressure controller. Discontinuous totalizing automatic weighing instruments (totalizing hopper weighers) have been designed in such a way that when the compressed air fails, the weighing instrument completes the current weighing cycle and then stops in the base position "Stop! - Empty" with the weighing container discharged. Any further weighing process is stopped. Only when sufficient compressed air (4 to 6 bar) is available again, is the bulk weigher released automatically by the pressure controller (7) to continue the loading or unloading process. The entire pneumatic system is located in position 7.

Since during the operation of discontinuous totalizing automatic weighing instruments (totalizing hopper weighers) no operating staff is present, it must be ensured by the mode of operation of the automatic

weighing instrument that faults in the weighing process are either eliminated by constructive measures or that they are detected and notified by automatic monitoring devices.

Possible faults in the weighing process are, for example

- exceeding the maximum capacity, or
- irregularity in the discharge hopper (discharge of the bulk product).

The following operating modes of a discontinuous totalizing automatic weighing instrument (totalizing hopper weigher) are possible:

- discharge weighing: weighing where the bulk product flows out of the previously tared, full weighing container and the mass of the removed product is directly indicated (subtractive weighing);
- back-weighing: weighing of the bulk product which remains in or on the load receptor after the weighing container has been discharged. The result of this weighing is subtracted from the weighing result that has previously been obtained for the filled weighing container. The mass of the full weighing instrument is stored, and the mass after discharge of the weighing instrument is subtracted from the previously stored value. The mass determined in this way is the current mass for the delivered bulk product quantity.

5 Circulating air compensation/air recirculation in the case of totalizing automatic weighing instruments (receiving and shipping weighers)

5.1 Sheathed system

The sheathed system is shown in Figure 5, for which the key is as follows:

1. Maintenance unit consisting of water separator, pressure reducer and, if applicable, lubricant.
2. Reserve compressed air container with back pressure valve and pressure controller.
3. Load cell cover.
4. Compressed air antifreeze device.
5. Terminal box for connecting the load cells.
6. Terminal box for the general connection of the electrical devices such as, e.g. solenoid valves, monitoring sensors, silo indicators, etc.

6 Circulating air compensation/air recirculation during filling and discharging (sheathed, closed system)

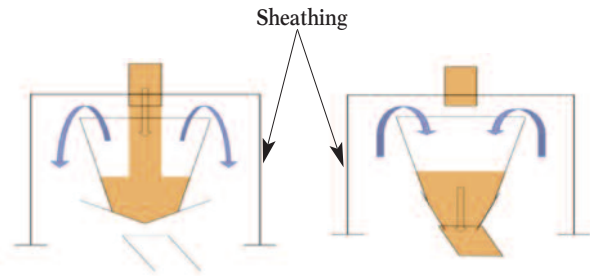

Figure 6 Air compensation/recirculation

In the case of sheathed, closed weighing systems, the air circulation compensation or the air recirculation do not, as a rule, represent any particular difficulty. When the bulk product flows or is let into the load receptor, the air present in the weighing container escapes into the lower part of the weighing system. When the product is discharged, the opposite process takes place, i.e. the product flowing out of the load receptor presses the air up, back into the weighing container.

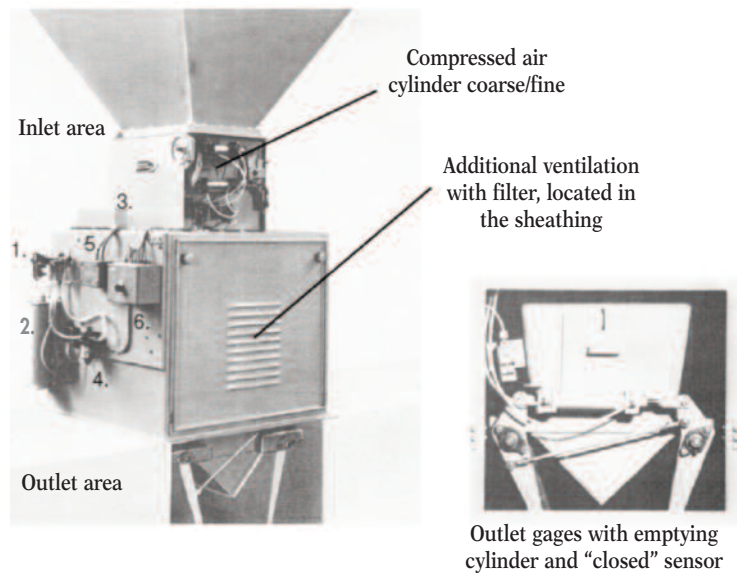

Figure 5.1 Sheathed system

7 Open system

The weighing load container is visible; the size of the inlet area and of the outlet area is the same - refer to Figure 7.

In the case of the “open weighing system”, the air recirculation during the filling or discharge processes is of great importance, and also of course for the weighing accuracy. It is therefore important that the size of the inlet and outlet areas is the same, so that no weighing difference occurs due to the air recirculation, especially not due to a strong “air suction” caused by the product flowing out.

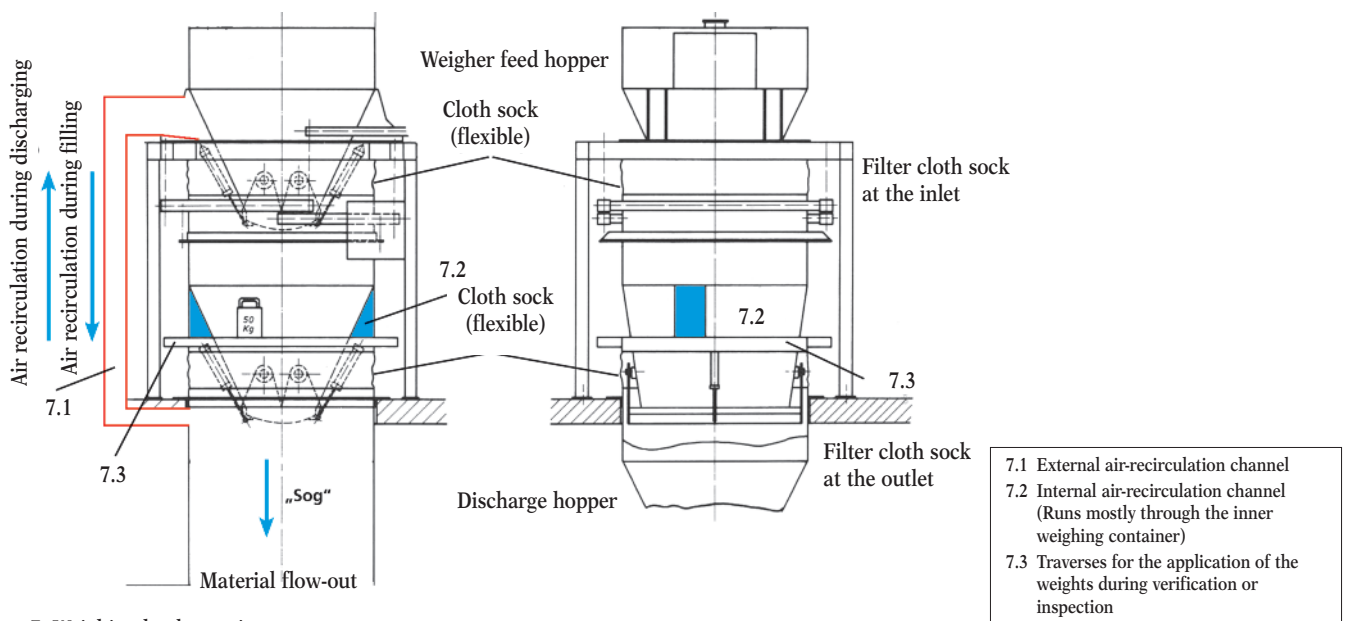

Figure 7 Weighing load container

8 Open system of conical design

The inlet and outlet areas are not the same size. The weighing container is visible - refer to Figure 8.

Due to the difference between the size of the outlet area and the – larger – size of the inlet area, weighing differences may occur. To prevent such weighing differences, suitable technical measures must be taken, especially when the air circulation is strong due to large amounts of loaded/unloaded bulk product which cause strong air suction when flowing out of the system.

Exceptions: In dosing weighers (e.g. in silos for concentrated feed), the inlet and outlet conveying speed of the bulk product is usually relatively low. Differences in the weighing results therefore hardly ever occur. Also, such dosing weighers are usually not subject to legal control.

9 Bulk controller – Key control levels. Static verification test with weights and dynamic control with static weighing operation and with a product

9.1 Introduction to the end of receiving/shipping

Mechanical shocks can, of course, also be caused by hammer mills, pellet presses, elevators, etc. This situation can be improved by means of vibration dampers and/or flexible connections between the steel plate area of the storage tank and the inlet area of the weighing instrument.

If such disturbances are not properly suppressed or eliminated, they may lead to the maximum permissible errors on verification or the maximum permissible errors in service being exceeded. This can also cause weighing errors during the receiving or shipping of loose bulk products.

The technology systems for the construction – as well as for the pneumatics, sensors, silo indicators, load cells and pressure cells – of receiving and shipping weighers are already comprehensive and substantial. Since the introduction of strain gauge load cells in the 1950s, mass has, among other things, been determined by force measurements and electronic components such as, for example, analogue-to-digital converters and the associated obligatory functional software. Today, many people – and even experts – are, for the above reasons, unfortunately no longer familiar with “mass” determination in practical applications.

In the following, we will deal in detail with the bulk controller, its functional software and the verification/technological tests and requirements according to OIML R 107. For this purpose, the “original data” of a totalizing receiving or shipping weigher in operation are used (see Figure 9 and Figure 10).

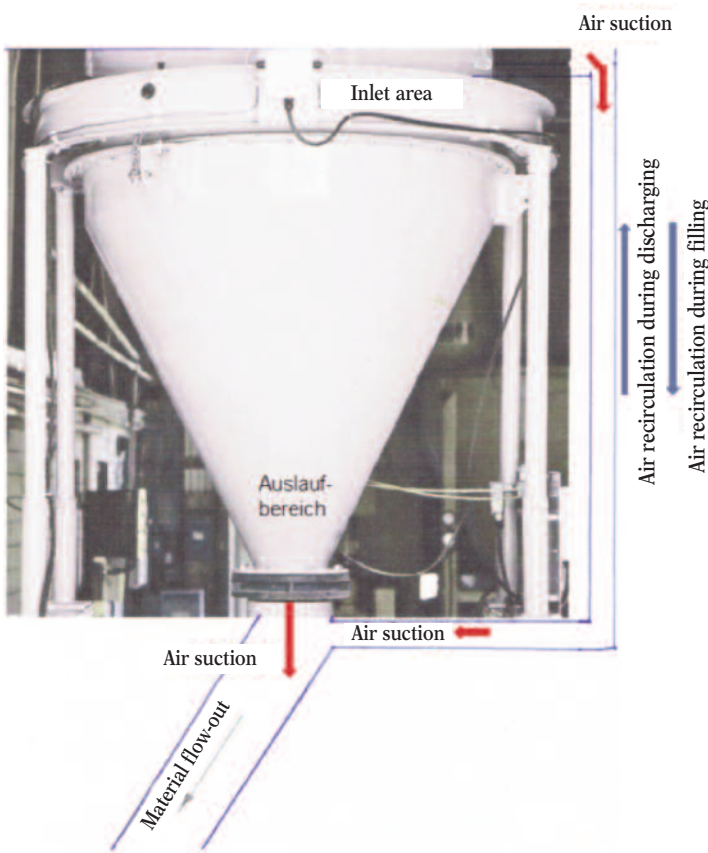

Figure 8 Weighing hopper

In the case of “open weighing systems” of conical design, too, an air-recirculation channel is needed during the loading/unloading operation. The “air suction” which originates from the bulk product flowing out causes a differential air influence, since the size of the inlet area is much broader than the size of the outlet area. Thereby, the air suction can be more or less strong.

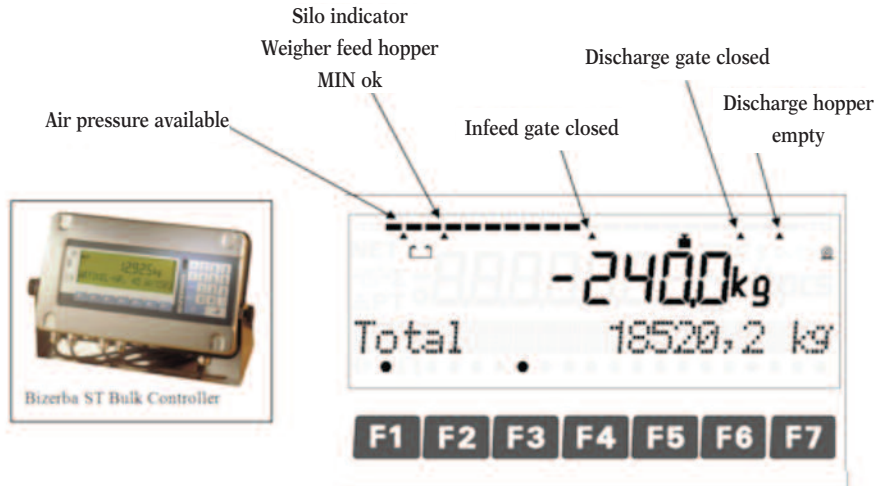



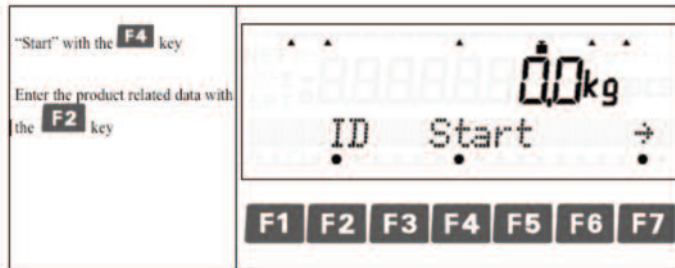

Figure 9 The most important, but simple and easy-to-understand control levels of a bulk controller: basic mask with display of the total mass showing the weighing instrument after the discharge (discharge weighing). Before, 240.0 kg of a product was on the receptor. The **“Total”** in the bottom row of the display indicates the new totalized mass.

Symbol Meaning

-  The weigher has been emptied.
-  The weigher has been verified. If it has not been verified, this symbol will flash.
-  Value at rest (stabilization time) of the weigher: The value at rest is just being recorded. This value at rest will then be added to the total mass.

Start



The weigher has started



When “Stop” is activated, the weigher will carry out the complete weighing cycle until the end. After discharge has taken place and after the discharge gates have closed, the weigher will interrupt the further

operating cycle in the state “Stop! – Empty”. The **“Prüfstop”** (“test stop”) function will be explained later in the section “Metrological requirements”.

The weigher has been stopped

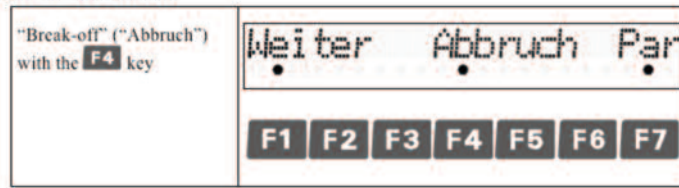

In the "stopped" state, the receiving/shipping mode can be continued with the "Weiter" – F1 key ("Continue"). This means that the next operating cycle begins with the

opening of the infeed gates. The receiving/shipping mode can be terminated with the "Abbruch" ("break-off") key.

Finish

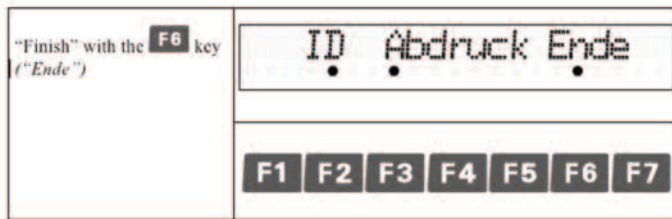

The printout from the printer which is connected to the bulk controller is often used as a delivery note. Apart from the date and the time of day, it contains the data of the customer or of the supplier as well as the product designation, etc. and, of course, the total mass of the weigher. By activating the "Ende" key, the bulk controller takes on its basic state and can then be restarted for the next receiving/shipping cycle.

9.3 Metrological requirements

9.2 Checking of totalizing automatic weighing instruments (TAWIs) according to OIML R 107

Static test with weights. Maximum permissible errors.

Load m , expressed in totalization scale intervals (d_t)	Maximum permissible error
$0 \leq m \leq 500$	$\pm 0.5 d_t$
$500 < m \leq 2\,000$	$\pm 1.0 d_t$
$2000 < m \leq 10\,000$	$\pm 1.5 d_t$

Note: The table above is identical to OIML R 76 Non-automatic weighing instruments (NAWIs) – Class III – Medium accuracy.

The totalization scale interval d_t must not be smaller than 0.01 % and not greater than 0.2 % of the maximum capacity Max of the TAWI.

Accuracy classes according to OIML R 107: 0.2, 0.5, 1 and 2 (only in exceptional cases).

Minimum capacity, Min: Smallest discrete load that can be weighed automatically.

Overload: The actual maximum discrete load on the load receptor is more than $9 d_t$.

Maximum permissible error of the mass of the totalized load in %.

The minimum totalized value load, Σ_{min} , must not be smaller than:

- a) the value of the load at which the maximum permissible error for automatic weighing on initial verification is equal to the totalization scale interval d_t , and
- b) not smaller than the minimum capacity, Min.

Refer to the Table at the top of the next page.

Example:

Accuracy class "0.5":

$d_t = 0.2 \text{ kg}$

$\Sigma_{min} \geq 400 d_t = 400 \times 0.2 \text{ kg} = 80 \text{ kg}$ and

Permissible error = $80 \text{ kg} \times 0.25 \%$ (at initial verification) = $0.2 \text{ kg}, d_t$

At 80 kg, the permissible error on verification is thus equal to the totalization scale interval d_t .

Accuracy class	Percentage of the mass of the totalized load in %		Smallest value of the totalized load (Σ_{\min})
	maximum permissible errors on initial verification	maximum permissible errors in service	
0.2	+/- 0.10 %	+/- 0.20 %	$1000 \times d_t$
0.5	+/- 0.25 %	+/- 0.50 %	$400 \times d_t$
1	+/- 0.50 %	+/- 1.00 %	$200 \times d_t$
2	+/- 1.00 %	+/- 2.00 %	$100 \times d_t$

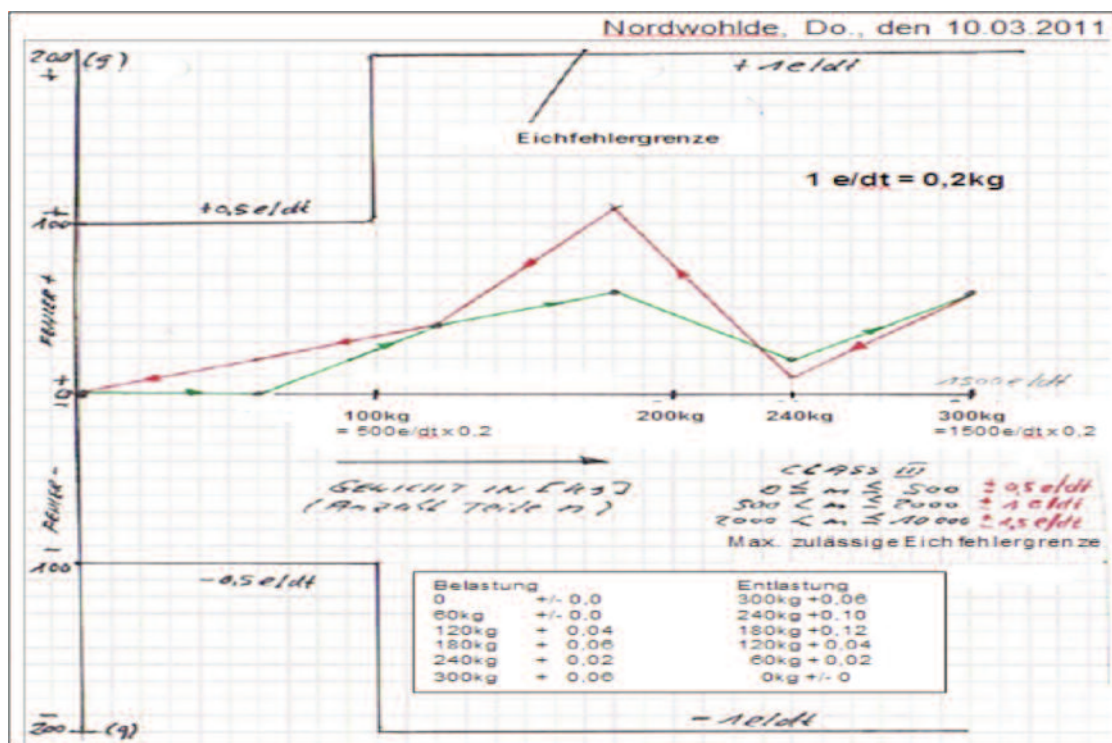

Figure 10 Test diagram with weights prior to the static verification test

A realistic example, related to the conversion/modernization described below:

Accuracy class “0.2”:

$d_t = 0.2 \text{ kg}$

$\Sigma_{\min} \geq 1000 d_t = 1000 \times 0.2 \text{ kg} = 200 \text{ kg}$

Permissible error = $200 \text{ kg} \times 0.1 \% \text{ (at initial verification)} = 0.2 \text{ kg}, d_t$

Verification plates: The verification plate shown at the top of the next page as an example was used at “Nordwohlder Mühle” in Norwohld (near Bassum/Bremen) – however not for the actual verification but for

the conversion of a mechanical Chronos weighing instrument into an electronic bulk weighing system (force measurement with load cell) Bizerba ST, 2010/2011.

EC type examination certificate: DE-09-MI006-PTB012, fabr. No.: 2162850/023694.

In the case of table housings, the verification plate is applied to the rear of the ST bulk controller.

The data plate of the weighing instrument is applied in a clearly visible way close to the electronic mass display.

The type plate is applied to the weighing instrument itself. Via the fabrication numbers on the verification

Type **Bizerba ST Bulk / G300 - 400** Ser. No. **2162850/023694**

Accuracy classes **0,2** Approval sign **DE-09-M1006-PTB012** Year **2010** **230 V** **50-60 Hz** **4-6 bar**

Max **300 kg** Min **20 kg** e **0,2 kg** d **0,02 kg** d_t **0,2 kg** T **-300 kg** **-10 °C** **+40 °C**

DISCONTINUOUS TOTALIZING AUTOMATIC WEIGHING INSTRUMENTS (TOTALIZING HOPPER WEIGHERS):

Products	Density kg/dm ³	Hopper capacity (dm ³)	Accuracy cl. (OIML R 107)	Σ _{min}	Σ _{min} ^{kg}	Initial verification (%)	In-Service (%)
Grain	0,5-0,75	400	<input checked="" type="checkbox"/> 0.2	1000 x d _t	200	± 0.10	± 0.2
			<input type="checkbox"/> 0.5	400 x d _t		± 0.25	± 0.5
			<input type="checkbox"/> 1.0	200 x d _t		± 0.50	± 1.0
			<input type="checkbox"/> 2.0	100 x d _t		± 1.00	± 2.0

Maximum permissible errors on initial verification (mpe-static): ± 0.5 e=d; for 0 ≤ m ≤ 500; ± 1.0 e=d; for 500 < m ≤ 2000; ± 1.5 e=d; for 2000 < m ≤ 10000 (loads m expressed in scale intervals e / totalization scale intervals d)

Max **300 kg** Min **20 kg** d_t **0,2 kg** T **-300 kg** Σ_{min} **200 kg**

Type **Bizerba ST Bulk / G300 - 400**

Fabr./Ser.No. **2162850/023694** Baujahr/year **2010**

Bizerba GmbH & Co. KG
72336 Balingen

plate of the ST bulk controller and the type plate on the weighing instrument, it is documented and ensured that these belong together.

9.4 Dynamic verification test in static weighing operation with a product

Tests with a bulk product

Bulk receiving or bulk shipping weighers in accordance with OIML R 107 or automatic totalizing hopper weighers must be tested with a bulk product at the place of installation under normal conditions. Prerequisites for the tests are, among other things, that the automatic totalizing hopper weigher is suited for the bulk product to be weighed, as well as for the efficiency of the mass comparator t/h and for the bulk product to be weighed.

All facilities which are close to the automatic totalizing hopper weigher or to the TAWI such as, for example, conveyor belts, dust-extractors, elevators, etc., must be in operation or must be operated during the testing. In the test procedures, special attention must be paid to oscillating air columns/air recirculation.

Test quantity

The tests with a bulk product must be carried out at loads close to Min and when the automatic totalizing hopper weigher is loaded with a test quantity which corresponds at least to the smallest quantity conveyed, Σ_{min}. In the functional test, at least 5 weighing cycles must be carried out.

Test procedure when the weighing unit of the automatic totalizing hopper weigher or of the TAWI is used as a weighing instrument for testing

If single loads are to be weighed in non-automatic operation, it must be possible to interrupt the automatic operation two times during each weighing cycle. If the automatic totalizing hopper weigher/TAWI is used as a weighing instrument for testing, the analogue display for the single test loads must be determined by the addition of standard weights, or a 10-fold higher resolution must be available for control purposes.

Interruption before discharging, after taring of the filled weighing instrument to 000.0 kg – I_T (A_{tare}): Push (Prüfstop – “Test stop”, see page 21)

The automatic determination of the mass after subtractive taring must be interrupted in automatic operation.

After the weighing system has come to a rest (after shakers, belts elevators and the dust-extracting system have been switched off and air pressure equalization has been effected), the analogue value of the mass is determined as the result of the weighing instrument for testing (“Stop! – Empty”) and recorded. After that, the automatic totalizing hopper weigher/TAWI is released for automatic operation.

Interruption after discharging and determination of the discharged product quantity – P_B (S_{gross} – Static): Push (Prüfstop – “Test stop”, see page 21)

After the discharged product quantity has been determined, automatic determination of the mass is again interrupted in automatic operation (after shakers, belts, elevators and the dust-extracting system have been switched off and air pressure equalization has been effected). The analogue value of the discharged product quantity of the mass is determined as the result of the weighing instrument for testing (“Stop! – Full”) and recorded. After that, the automatic totalizing hopper/TAWI is released for automatic operation.

TAWI – Weighing instrument with discharge weighing		kg
I_T test stop Tara = Print or displayed value of the i^{th} single load A_{tare} / autom. operation	I_T	000.0
P_T test stop Tara = Displayed value of the i^{th} single load S_{tare} / in non-automatic operation	P_T	+ 000.00
I_B test stop Gross = after hopper discharge in A_{gross} / automatic operation	I_B	- 240.0
P_B test stop Gross = after hopper discharge S_{gross} / in non-automatic operation Weight addition	P_B	- 239.98 +000.02 - 240.00
Maximum permissible error on initial verification: $240.0 \text{ kg} \times 0.1 \% = \pm 0.240 \text{ kg}$. Test OK and passed. $E = \text{Error}$	E	- 000.02

I_T – tara- A_{tare} – value in automatic operation of the instrument after subtractive tare of the filled receptor

I_B – gross- A_{gross} – gross weight value in discharged mass in discharged mode

P_T – test stop Tara = S_{tare} tare value in non-automatic (**static**) mode

P_B – test stop Gross = S_{gross} gross load in non-automatic (**static**) mode

$E = \text{Error of measurement}$, $E = A_{\text{net}} - S_{\text{net}} = (- 240 \text{ kg} - 239.98 \text{ kg} = - 000.02 \text{ kg})$

Coming in 2015

The next two articles in this series will be on OIML R 61 *Automatic gravimetric filling instruments - AGFI - Bagging / Big bag*, and R 51 *Automatic catchweighing instruments - checkweighers and price labellers for discount groups*. ■

INFRASTRUCTURES

The development and transformation of national metrology legislation in Ukraine

OLEH VELYCHKO,
 Director of the Institute of State Enterprise
 “Ukrmetrteststandard”,
 Kyiv, Ukraine

1 Introduction

Modern metrology is characterized by close collaboration and cooperation among all the countries in the world, since a single country cannot accomplish all the necessary metrological tasks alone. Metrology is a discipline in which the key element is a high degree of international, regional and national coordination [1–4].

With the growth of globalization and regionalization, new trade requirements and economic prerequisites arise which must be resolved by the national metrological infrastructures. In fact, the aim of these infrastructures is to achieve an acceptable level of satisfaction on the part of society, industry and the scientific community. However, developing adequate coordination of the concepts of legal, fundamental and industrial metrology at the national level, together with their requirements and procedures, is a difficult and lengthy process.

For the Global Metrology System to function effectively, above all harmonization is required at the national level of metrology legislation on the basis of the relevant documents, Recommendations and standards of the various international organizations involved. The OIML was established to promote the global harmonization of legal metrology procedures and OIML D 1 *Considerations for a Law on Metrology* [5] is particularly instrumental in this. Ukraine has been an OIML Corresponding Member since January 1997 [6, 7].

Transforming national metrological legislation with the aim of effectively adapting the activity of the National Metrology Service to bring it into line with modern requirements in the framework of the Global Metrology System is an important and difficult task.

2 National metrology legislation

The legislative basis of the *State Metrology System and the State Committee of Ukraine for Standardization, Metrology and Certification* (Derzhstandard, DSTU) was established when Ukraine gained independence in 1992. This was done via a decree of the Cabinet of Ministers of Ukraine entitled *On traceability assurance* (no. 40-93 dated 1993-04-26) with traceability assurance as one of its responsibilities.

In 1996 a draft law entitled *On metrology and metrological activities* was developed which highlighted all the major aspects of the organization and management of metrological activities. It was accepted by the Verkhovna Rada of Ukraine (the national Parliament) and adopted as Ukrainian Law in 1998. The content of this law has been harmonized with the guidelines of OIML Documents such as

- OIML D 1:1975 *Law on metrology*,
- OIML D 3:1979 *Legal qualification of measuring instruments*,
- OIML D 12:1985 *Fields of use of measuring instruments subject to verification*,
- and other relevant documents [6, 7].

The modern legislative basis of the National (State) Metrology Service of Ukraine includes the Law of Ukraine *On metrology and metrological activities* (no 113/98 of 1998-02-11), updated in 2004 (no 1765-IV of 2004-06-15). Present day activities of the State Metrology Service are based on this law on units of measurement, standards and measuring instruments. The main provisions of this law are harmonized with standards, rules on metrology and OIML publications which are generally accepted throughout the world [8, 9].

Derzhstandard was transformed into the State Committee of Ukraine for Technical Regulation and Consumers’ Police (Derzhspozhyvstandard, DSSU) in 2000. From 2011 its functions in the field of metrology were transferred to the Department of Technical Regulation (DTR) of the Ministry of Economic Development and Trade of Ukraine (MEDT).

Work on developing a new draft of the Law *On metrology and metrological activities* has been ongoing since 2011. European experts are also involved in the drafting process.

3 National metrological organizational structures

The State (National) Metrology Service (NMS) of Ukraine comprises

- the DTR of MEDT,
- State Scientific Metrological Centers (SSMC),
- the Service of Uniform Time and Etalon Frequencies (SUTEF),
- the Service of Reference Materials for the Composition and Properties of Substances and Materials (SRMCP),
- the Service of Standard Reference Data on Physical Constants and Properties of Substances and Materials (SSRD),
- metrological centers, and
- regional bodies [10, 11].

The main objectives of the DTR focus on implementing common scientific and technical policy in the field of metrology, including

- organizing and carrying out fundamental research in the field of metrology,
- organizing and developing national measurement standards,
- determining procedures for the development, approval, registration and maintenance of measurement standards, as well as their comparisons with national and international measurement standards,
- determining the general metrological requirements for measuring instruments, equipment and measurement procedures,
- type approval of measuring instruments,
- determining general requirements for the verification, calibration and metrological evaluation of measuring instruments, and
- participating in cooperative projects with international organizations.

The main SSMC in Ukraine are the National Scientific Centre “Institute of Metrology” (NSC “IM”, Kharkiv) and the State Enterprise “All-Ukrainian State Scientific and Research Centre of Standardization, Metrology, Certification and Consumer Protection” (SE “Ukrmetrteststandard”, Kyiv).

The NSC “IM” is a leading center for assuring the uniformity of measurements in Ukraine. Its role is to

- carry out fundamental and applied research in the field of metrology,
- organize the development, maintenance and improvement of national and secondary measurement standards used in traceability schemes,
- carry out state testing of measuring instruments in designated fields of measurements,
- carry out verification and metrological certification of measuring instruments in designated fields of measurements, and
- develop normative documents in the field of metrology.

SE “Ukrmetrteststandard” is designated as a leading center of the NNS of Ukraine. It performs the following functions:

- development, maintenance and improvement of measurement standards;
- maintenance of the national (state) register of approved types of measuring instruments;
- state testing of measuring instruments in designated fields of measurements;
- verification and metrological certification of measuring instruments in designated fields of measurements;
- realization of state metrological supervision (SMS) in designated regions;
- development of normative documents in the field of legal metrology (testing for type approval and verification of measuring instruments, etc.).

The main objective of the metrological centers and the regional bodies are initial verification, re-verification and metrological certification of measuring instruments, and the realization of state metrological supervision in designated regions.

4 The scope of the activities of the National Metrology Service

State metrological control and supervision (SMCS) is exercised by the NMS in accordance with a procedure laid down by the DTR [10, 11].

The domains of responsibility of the SMCS concerning both business and the public are

- measuring instruments and measurement data acquisition systems,
- measurement methodology and normative documents specifying the requirements for measurements,
- prepacked products during packaging and selling, and
- other fields envisaged by the metrological regulations and rules.

The State Metrological Supervision (SMS) covers measurement results used for

- diagnosis and curing of human illnesses,
- quality inspection of drugs,
- quality and safety inspection of foods,
- environmental inspection,
- job safety inspection,
- geodesic and hydro meteorological work,
- trade and commercial operations and settlements between a purchaser (consumer) and a seller (supplier, manufacturer, executor) including the fields

- of personal and public services, telecommunications and postal services,
- fiscal, banking and customs operations,
- records of energy and material resources (electrical and heat power, gas, water, oil products, etc.) except internal records made by enterprises, organizations and citizens as business entities,
- work carried out on the instructions of the courts, public prosecutor's office, arbitration court and other public bodies,
- mandatory product certification, and
- registration of national and international certificates.

The following types of state metrological control (SMC) are established:

- state tests and type approval of measuring instruments;
- metrological certification of measuring instruments;
- verification and re-verification of measuring instruments;
- accreditation for the right to carry out state tests, verification of measuring instruments, perform measurements and carry out certification of measurement procedures, etc.

Measuring instruments produced in series or imported into Ukraine in batches are subject to state acceptance and inspection tests for conformity with the approved type. Approved types of measuring instruments are entered by the DTR into the state register of measuring instruments authorized for use in Ukraine. Measuring instruments which are not subject to state tests, and which fall within the scope of the SMS, are subject to metrological certification.

Measuring instruments which fall within the scope of the SMS, and which

- are in operation,
- have finished production,
- have been repaired and released for sale,
- have been hired out, or
- have been imported into Ukraine
- are subject to verification.

In Ukraine, the mandatory condition for type approval and the verification and re-verification intervals for the most widespread measuring instruments are as follows [10, 11]:

- trade scales:1 year
- gas meters:5 years
- water meters:2 years
- heat meters:2 years
- electricity meters:8–16 years
- taximeters:1 year
- noise meters:1 year

- gas analyzers:1 year
- medical glass thermometers:x
- tonometers:1 year
- fuel dispensers:1 year
- manometers:1 year
- dosimeters:1 year
- alcoholometers at exhalation:1 year
- instruments for checking velocity: ...1 year

5 The main ways of transforming national metrology legislation

The NMS legislative basis, its rules and its technical and organizational basis in Ukraine are defined by the Ukrainian law on metrology. Harmonization of the NMS activity with the requirements of international standards, guides and recommendations in the field of metrology is a very complex task not only due to differences in economic development, but also due to differences in national legislation ideology and structure [11, 12].

The approach of national metrological legislation to international standards and practice is rendered complex by several factors, such as the difficulty in selecting the metrology system model, uncertainty in the selection of the appropriate documents, limitations to practical implementation, problems with inadequacy of terms and definitions, etc.

The conception of the new draft of the Ukrainian law on metrology should take into account the need for gradual, step by step implementation of the changes to the metrology regulations in order to avoid any unpredictable negative after-effects. As a result of the implementation of this law, the concepts of calibration, traceability of measurement and metrological conformity should be implemented into metrological practice in compliance with the definitions in the relevant international Recommendations, vocabularies and standards [13, 14].

The requirements of the European Directive 2014/32/EU on measuring instruments (MID) [16] have been declared as being the basis for the transformation in Ukraine of the regulations on legal metrological control of measuring instruments. The concepts of calibration, traceability of measurement and metrological conformity are implemented into metrological practice in compliance with the relevant definitions in the VIM and in ISO/IEC 17025 [13, 16].

On 5 June 2014 the Parliament of Ukraine adopted a key new legal act: the *Law on Metrology and Metrological Activities* (no. 1314-VII dated 2014-06-05). The adoption of this law signifies a major breakthrough in the

modernization of Ukrainian technical legislation and its alignment with the requirements of the World Trade Organization and the EU. The new law aims at creating an effective and transparent metrology system in Ukraine and will ensure that metrological activity is carried out on the basis of international and European requirements (e.g. OIML D 1, European Directives and WELMEC Guides). A clear delineation of administrative and commercial metrological services will contribute significantly to the elimination of corruption-inducing conflicts of interest.

The main components of the new national metrological legislation are as follows:

- organization structure;
- equipment subject to national control;
- type approval;
- initial verification and re-verification;
- metrological inspection (supervision); and
- calibration service.

The main components of the current state (old Laws, 1993, 1998, 2004 from 1993-04-26 to 2014-07-01) and the transformation of the national metrological legislation (new Law from 2016-01-01) in Ukraine are shown in Table 1.

A major part of the transformation of the national metrology legislation in Ukraine is a transition from SMCS to the conformity assessment of measuring instruments and the verification of instruments in use. Conformity assessment of legally regulated measuring instruments to the requirements of technical regulations, including initial verification and type approval, shall be performed if it is provided for by the relevant technical regulations. The type approval certificate of an instrument is a document that confirms that the type has been approved.

Conformity assessment of instruments to the requirements of technical regulations shall be performed by the appointed conformity assessment bodies. The conformity assessment procedure shall be established by the technical (and other) regulations. Conformity assessment of instruments that are not used in the area of legally regulated metrology shall be conducted on a voluntary basis.

Legally regulated measuring instruments in use shall be liable to periodic verification and verification after repair, and may also be subject to extraordinary, expert and inspection verification. Verification of measuring instruments not used in the area of legally regulated metrology and which are in use shall be performed on a voluntary basis.

In Ukraine, the accreditation of calibration laboratories is also conducted in line with the requirements of the special law of Ukraine *On accreditation of conformity assessment bodies* (no. 2407-

III dated 2001-05-17) in accordance with the requirements of ISO/IEC 17025 (article 10) [16].

6 Summary

The new national law on metrology will allow national metrological legislation to be adapted to the requirements of the most recent standards and recommendations of the various international metrology organizations, and will also allow the activity of the national metrology service in Ukraine to be effectively promoted. ■

References

- [1] M. Kochsiek. *Trends in legal metrology towards a global measurement system*. OIML Bulletin Vol. XLIV No. 1 Jan. 2003 pp. 7–9.
- [2] M. Kochsiek, A. Odin. *Towards a global measurement system: Contributions of international organizations*. OIML Bulletin Vol. XLII No. 2 April 2001 pp. 14–19.
- [3] M. Kochsiek, A. Odin. *An efficient metrological infrastructure – benefit for industry and society*. OIML Bulletin Vol. XXXIX No. 2 April 1998 pp. 26–32.
- [4] M. Kochsiek, A. Odin. *NMIs in present-day metrology*. OIML Bulletin Vol. XXXVII No. 2 April 1996 pp. 27–32.
- [5] OIML D 1:2012: *Considerations for a Law on Metrology*.
- [6] O. Velychko. *Metrological activity in Ukraine*. OIML Bulletin Vol. XXXVIII No. 3 July 1997 pp. 36–41.
- [7] O. Velychko. *Harmonization of the legislative acts and normative documents on metrology in Ukraine*. OIML Bulletin Vol. XLI No. 2 April 2000 pp. 19–24.
- [8] O. Velychko, T. Gordiyenko. *Implementation of the European Directive on Measurement Instruments in Ukraine*. OIML Bulletin Vol. LI No. 2 April 2010 pp. 23–29.
- [9] O. Velychko. *The optimization of multifunctional national metrological systems*. OIML Bulletin Vol. LI No. 3 July 2010 pp. 11–16.
- [10] O.N. Velichko. *Metrological activity in Ukraine*. Measurement Techniques Vol. 42 December, 1999 No 12 pp. 1109 – 1115.

Table 1 Components of the current state and transformation of the national metrological legislation

Component	Current state at 2014-07-01 (current Law)	Transformation from 2016-01-01 (new Law)
Organization structure	<p>State Metrology Service (article 13);</p> <ul style="list-style-type: none"> • DTR of MEDT (article 14); • SSMCs (article 15); • SUTEF, SRMCP, and SSRD (article 16); • regional bodies of MEDT; • metrological services of central bodies of executive power, enterprises and organizations (article 17) 	<p>National Metrology Service (article 9):</p> <ul style="list-style-type: none"> • DTR of MEDT (article 10); • <i>the central body in the SMS;</i> • SSMCs (article 12); • SUTEF, SRMCP, and SSRD (article 13); • state enterprises of MEDT; • metrological services of the central bodies of executive power, enterprises and organizations (article 14); • <i>conformity assessment bodies for measuring instruments and verification laboratories</i>
Equipment subject to national control	<ul style="list-style-type: none"> • objects of the SMCS (article 19); • scopes of the SMCS (article 20); • types of the SMCS (article 21) 	<ul style="list-style-type: none"> • metrological supervision and its types (article 20); • <i>state market surveillance of the compliance of legally regulated measuring instruments with the requirements of technical regulations</i> (article 21); • <i>metrological supervision of legally regulated measuring instruments in use</i> (article 22); • metrological supervision of pre-packaged goods (article 23)
Type approval	<ul style="list-style-type: none"> • approval by the DTR of MEDT (article 26); • realization of state testing by the SSMCs (article 26); • realization of state testing by the regional bodies (article 26) 	<ul style="list-style-type: none"> • <i>conformity assessment of measuring instruments</i> (article 16); • <i>procedure for conformity assessment of legally regulated measuring instruments</i> (article 16); • <i>procedure for maintaining the State Registry of approved types of measuring instruments</i> (article 16)
Initial verification and re-verification	<ul style="list-style-type: none"> • realization by the regional bodies (article 28); • realization by the SSMCs (also using national measurement standards) (article 28); • authorization in SMS (articles 22, 23) 	<ul style="list-style-type: none"> • <i>initial verification – module of conformity assessment of measuring instruments</i> (article 16) • verification of measuring instruments in use (article 17); • authorization for performing verification of measuring instruments in use (article 18, 19)
Metrological inspection	<ul style="list-style-type: none"> • realization of SMS by the metrological centers and regional bodies (articles 29, 30); • realization of SMS by the metrological inspectors (articles 31–35) 	<ul style="list-style-type: none"> • powers of the central body in the area of metrological supervision (articles 24); • rights and obligations of state metrological supervision inspectors (articles 25, 26)
Calibration service	<ul style="list-style-type: none"> • realization of calibration by the SSMCs (article 40); • realization of calibration by the metrological centers and regional bodies (article 40) 	<ul style="list-style-type: none"> • calibration of measuring instruments in general (article 27); • realization of calibration of measuring instruments by the SSMCs, calibration laboratories and metrological centers (article 27)

- [11] O. Velychko. *Transformacion moderna de los sistemas metrologicos multifuncionales nacionales*. Boletin Cientifico Tecnico INIMET No 2 de 2011 (julio–diciembre) 9–25 (in Spanish).
- [12] O. Velychko, S. Pronenko. *Toward the transformation of national metrology legislation*. Proceedings of Intern. Metrology Conf. CAFMET 2010. Cairo, Egypt 2010 7 p.
- [13] OIML V 2-200:2012. *International Vocabulary of Metrology - Basic and General Concepts and Associated Terms (VIM)*. 3rd Edition (Bilingual E/F). (Edition 2010 with minor corrections).
- [14] OIML V 1:2013 *International vocabulary of terms in legal metrology (VIML) (bilingual French-English) / Vocabulaire international des termes de métrologie légale (VIML) (bilingue français-anglais)*.
- [15] *Directive 2014/32/EU of the European Parliament and of the Council of 26 February 2014 on the harmonisation of the laws of the Member States relating to the making available on the market of measuring instruments (recast)*. Official Journal of the European Union L 96/149. 29.3.2014.
- [16] ISO/IEC 17025:2005 *General requirements for the competence of testing and calibration laboratories*.

Oleh Velychko

*Director of the Institute of State Enterprise
"Ukrmetrteststandard",
Kyiv,
Ukraine*



CUBA

Metrology and globalization

YSABEL REYES PONCE,
INIMET, Cuba

Introduction

Globalization reaches all fields of human development, and therefore metrology is no exception.

The most disadvantaged sovereign states have to accept terms or actions that may be detrimental to their performance and hence their sovereignty. Trade is one of the most affected areas, restricted as it is by technical barriers that sometimes prevent the fulfillment of requirements. The states with less means must act quickly, take initiatives and be creative if they intend to be competitive under such circumstances.

In this situation they play a key role, as they must design policies and infrastructures that make their activity credible, and they must all speak a single language despite the differences in their level of economic development.

In today's globalized world, metrology is responsible for identifying the determinants to guarantee the fulfillment of requirements, indicators and specifications needed to make competitive quality goods and services of international acceptance, which facilitates the elimination of technical barriers to trade on the basis of the mutual recognition of reliable, safe and comparable measurement results.

Globalization in metrology involves the use, insofar as it is possible, of widely recognized international documents – in the broadest sense of the word *document* [1] – that is, policy statements, procedures, specifications, calibration tables, charts, manuals, posters, signs, memoranda, software, drawings, plans, etc. that lay the foundations of the aforesaid documentary infrastructure. In the case of international normative documents, they can be adopted as recommended or mandatory, according to each country's needs and interests. Globalization in metrology also entails, among other things, the use of the SI as an expression of uniformity in reporting measurement results and the reproduction of units of measurements, i.e., their realization as established at international level by official organizations and bodies.

Objectives

In keeping with Cuba's plans to create a general embracing culture of metrology among professionals and people at large and, particularly, to make both the staff in charge of the measurements and our goods and services more competitive, the present article approaches some topics of metrology that demand Cuba's special attention in today's globalized world in order to guarantee the right conceptualization and understanding at national and international level, speaking a common language to adequately reach the above-mentioned goals.

Development

Global system of measurement

Within the framework of globalization, metrology operates under a global system of measurement made up of various actors of paramount importance to any successful process, especially the international organizations that provide for the worldwide uniformity of measurement results, compliance with product and service specifications, and quality measurements, which involves technical elements centered on the individual, who is in charge of carrying out the measuring process with the accuracy and quality that globalization requires.

The most important international organizations in this respect are:

- International Organization of Legal Metrology (OIML);
- World Trade Organization (WTO);
- International Organization for Standardization (ISO);
- International Electrotechnical Committee (IEC);
- International Bureau of Weights and Measurements (BIPM);
- International Laboratory Accreditation Cooperation (ILAC);
- International Accreditation Forum (IAF).

According to their field of knowledge, each of them makes the following contributions.

Basic regulations on metrology

In its capacity as facilitator to unify metrology-related activities in its member countries, the OIML provides guidance on how to deal with every aspect of measurement and its legal treatment – based on OIML D 1 – and the criteria to be followed in order to set

up the Law and its purposes [2]. Globalization in metrology presupposes that each country abides by these recommendations in such a way that their metrological infrastructure complies with the relevant provisions and thus contributes to the mutual recognition of results and the elimination of technical barriers to trade, among other goals.

Cuba relies on its *Law of Metrología* [3] – *Decree-Law 183*, currently under revision – which covers the following subjects:

- a legal system of units of measurement;
- measuring instruments and systems;
- physical standards and metrological traceability;
- official time;
- National Service of Metrology and its authority;
- legal metrological control;
- manufacture, importation, marketing, repair, leasing and sale of measuring instruments and systems;
- enforcement: violations, sanctions, etc.

This essential document also includes considerations about the institutional framework for metrological assurance in the fields of production, services, science and technological innovation. Its contents must be known to, and in some cases mastered by, both the metrological community and the leaders of measurement-related organizations.

Some of the elements addressed in this Law are paramount to quality in measurement, since they cover all the objective and subjective aspects that play a key role in the expected results. The latter are linked to the staff and their competence, whereas the former relate to various factors, as summarized in Figure 2.

Competence of personnel

As stated above, a globalized world imposes the use of a common language and common actions in such a way

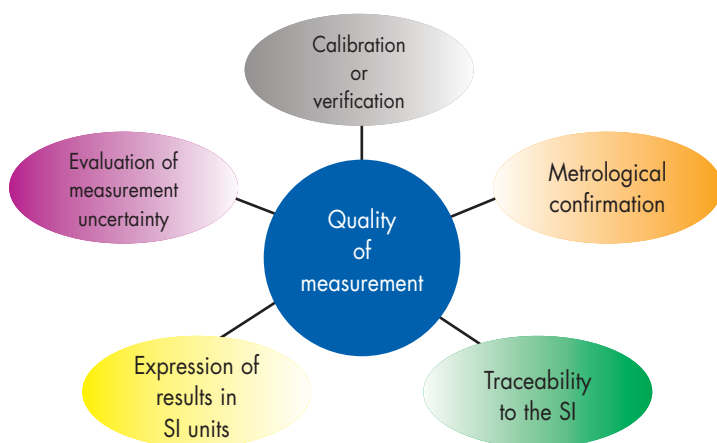

Figure 2 Main elements to achieve quality in measurement

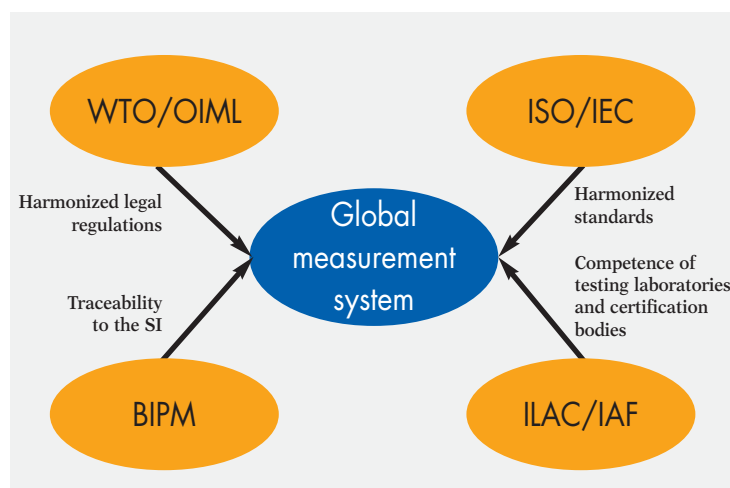

Figure 1 Role of international organizations in the global system of measurement

that everyone clearly understands what needs to be done and how to do it. The correct use of terms and their definitions, which opens the door to comprehension among the parties by facilitating the identification and understanding of the relevant activity, is pivotal.

For the sake of communication among metrologists, the OIML published OIML V 2-200:2010 *International Vocabulary of Metrology – Basic and General Concepts and Associated Terms (VIM)*, adopted by Cuba [4]. Today we already apply the 2012 edition of the VIM (OIML V 2-200:2012). Among others, the terms and definitions described in this document relate to:

- field of application;
- quantities and units;
- measurements;
- devices for measurement;
- properties of measuring devices; and
- measurement standards.

Regarding the use of the words measure and measurement, the document itself underscores the possibility of using either, so in this article preference is given to the term measurement taking into account the traditional and widespread use of this term. The VIM is the kind of document that all metrologists should rely upon on a daily basis, as it provides all the necessary elements of global communication on metrology and states that, when it comes to this field, it will have priority of use if any of its terms is defined in the vocabulary of other fields of knowledge or by another organization.

Laboratory competence

Mutual recognition of measurement results is based on the laboratory's demonstration of technical competence.

ISO and the IEC published a document describing how competent laboratories should perform and the management and technical requirements they should meet if they expect international recognition of their measurements.

To this end, Cuba adopted the said document [1] and has used it since 2006 as a stepping stone to meet the requirements that make it possible for testing and calibration laboratories to prove their competence in measurement.

The document cross-references management requirements to ISO management system requirements, including:

- document approval, issue and changes;
- review of requests, tenders, contracts, and purchase of services and supplies;
- subcontracting of tests and calibrations;
- service to the customer;
- control of nonconforming work, complaints, improvement;
- corrective and preventive actions, technical records;
- internal audits and management reviews.

While each of these elements plays a key role *vis-à-vis* the right performance of laboratory management, an essential purpose is served by management reviews, which cover – if properly conducted – all the above elements and provide complete and comprehensive information about laboratory activity, in addition to the fact that this process involves the entity's top management, including the leaders of its political organizations, as sources of insight and experiences with a view to decision-taking and improvement.

The technical requirements address every aspect needed to make reliable measurements, namely:

- personnel;
- facilities and environmental conditions;
- standard and non-standard measurement methods and method validation;
- estimation of uncertainty of measurement;
- measuring equipment and measurement traceability;
- reference standards and reference materials; and
- sampling.

Laboratory accreditation, a voluntary act that gives organizations an advantage and provides confidence among customers, can help provide evidence of competence.

If a laboratory is evaluated as competent and its competence is supported by accreditation, then it can be deemed to be a laboratory accredited to the international requirements of ISO/IEC 17025 and operating under an ISO 9000 [5] management system.

Uniformity and accuracy of measurements

Uniformity and accuracy of measurements means that measurement results should be expressed in legal units and with a given level of probability (uncertainty).

Traceability of measuring equipment, referred to calibration through a chain of metrological traceability or to verification in the case of legal metrology, leads to the establishment of its level of accuracy and reliability. The OIML counts on its various technical committees to develop recommended normative documents of methods to carry out measurements. As far as it is possible and necessary, the OIML Member Countries – 60 Member States, including Cuba, and 67 Corresponding Members – adopt these documents, which allows them to optimize their resources by avoiding duplicate measurements and thus eliminate technical barriers to trade.

Cuba has normative documents in place for the calibration and verification of measuring instruments and systems for conventional mass, pressure, volume, electricity, density, dimensional, physicochemical, temperature and radiation measurements, among other quantities.

OIML Recommendations have been the basis of our normative documentary infrastructure for the calibration and verification of measuring equipment and, as such, they have contributed to the uniformity of our results.

From time immemorial, the units of measurement have been pivotal to materialize the exchange of goods and trade in general. All countries need to speak a single language and be able to mutually recognize their results based on a common way of expression using widely accepted units of measurement.

Within the global measurement system, the uniformity of measurement results and traceability are indissolubly linked to one another. Although the traditional concept of traceability refers to the measurement units of the International System of Units (SI), its meaning has extended to make room for other references for the benefit of a uniform expression of results of other kinds of measurements, for instance, chemical, biological and microbiological.

To this end, the BIPM [6] has issued a guide to preserve the uniformity and proper use of measurement units worldwide that includes:

- definitions of measurement units;
- classification;
- conversion from other systems of units; and
- SI grammar.

More and more countries are joining the Metre Convention and thus adhering to this form of global expression of measurement units as a way to eliminate technical barriers to trade. In this connection and taking

into account that the transition to a different system of units has strong economic implications, alternatives are allowed at international level to keep such a transition on hold until a definitive solution to that problem is found, for instance, through the visible use of conversion tables for the said units.

Cuba has established both the legal measurement units [7] and those still accepted on a temporary basis, and there is a mandatory program underway for the development and implementation of plans to eliminate the unaccepted units as soon as possible.

The base SI units are the ampere (A), candela (cd), kelvin (K), kilogram (kg), metre (m), mole (mol), and second (s). This stems from historical rather than logical reasons: the selection of these seven base units is somewhat arbitrary and could have been made in a different way. In this system, the kilogram remains the only materialized unit.

As to the measurement units and their definitions, governments and metrologists alike should be on the alert for the decisions of the General Conference of Weights and Measures (CGPM) [8] which, in light of technological and scientific progress and the evidence of some inconsistencies in the sustainability of some standards' parameters (taking into account the results of their preservation or the calculation of their constants), has redefined some units so that they are all derivable from constants of nature and have clear boundaries.

The kilogram redefinition affects the realization of other measurement units, e.g., the ampere, and this must be kept in mind.

It is recommended that the traditional representation of the system be maintained to protect its historical link with traditional language, but the order to present such units will change to: s, m, kg, A, K, mol, and cd. The second and the metre keep their definition, but not their form of expression perhaps.

The universal constants associated with each of the base units are:

- the ground state hyperfine splitting frequency of the caesium-133 atom, $\Delta\nu(^{133}\text{Cs})_{\text{hfs}}$, is exactly 9 192 631 770 Hertz, Hz;
- the speed of light in a vacuum c is exactly 299 792 458 metres per second, $\text{m}\cdot\text{s}^{-1}$;
- the Planck constant h is exactly $6,626\ 06 \times 10^{-34}$ joule second, J·s;
- the elementary charge e is exactly $1,602\ 17 \times 10^{-19}$ C;
- the Boltzmann constant, k_B , is exactly $1,380\ 6 \times 10^{-23}$ joule per kelvin, $\text{J}\cdot\text{K}^{-1}$;
- the Avogadro constant, N_A , is exactly $6,022\ 14 \times 10^{23}$ mol^{-1} ;
- the luminous efficacy of monochromatic radiation of frequency 540×10^{12} Hertz is exactly 683 lumen per watt, $\text{lm}\cdot\text{W}^{-1}$.

In addition to the fact that all units are derivable from constants of nature, the new SI will allow significant changes in the standard relative uncertainty of some fundamental physical constants.

All this will surely have practical, technical and legal implications for some (mainly developing) countries.

Expression of measurement uncertainty

For all purposes, measurement uncertainty provides information about the quality of the result, which the lower it is, the better the result, as long as no source of uncertainty or element of interest has been distorted or neglected during the estimation.

Various international bodies and organizations approach the estimation of uncertainty in areas of their interests. The *Joint Committee for Guides in Metrology* (JCGM) of which the OIML is a member organization developed the *Guide to the expression of uncertainty in measurement* [9], known as the GUM, as the starting point for the scientific community to develop specific procedures for this parameter.

This is a topic of concern to some metrologists because of the difficulties for several fields of knowledge and the form that some concepts are presented in the GUM, which is not easy to understand and lacks examples for some kinds of measurements. In order to estimate uncertainty in biological and microbiological measurements – mostly linked to an exponential distribution – a broader treatment of chemical measurements and more specific information and examples are needed. Lack of total competence to estimate uncertainty calls for the establishment of a working group whose members have deep knowledge of, for instance, the parameter to be measured, its process of origin, its method of measurement, mathematics, and statistics. This is a topical subject that Possolo [10], 2013, recently discussed in depth and to which efforts are being devoted for the sake of better understanding and more representative examples.

Globalization in metrology is evidenced by the fact that, nowadays, measurement results are often not accepted without a statement of uncertainty. We speak of measurements in general, that is, for any purpose: calibration, testing, special measurements and, recently, verification as well.

Despite these considerations, many editorial boards or committees – even top-ranking ones – often fail to demand information about the expression of the measurement uncertainty as a requirement of acceptance of a journal article, even if it is valid scientific proof of the relevant result.

Measurement management system

Many examples can be cited of the importance of measurements. Quality becomes obvious in production and service processes that use measurements through the guarantee of compliance with the standards and the metrological confirmation of the measuring equipment involved to make sure that they give the right indications. Quality cannot be achieved without quality measurements.

The measurement process encompasses all measurements carried out in the stages of design, testing, production and inspection, which can include research and technological innovation activity. Figure 3 shows the model proposed by ISO for this system [11], adopted by Cuba in 2007.

This system has two key stages at input and output level, namely the customers and their process measurement requirements and the results achieved in keeping with their request. Its conceptualization includes the following elements:

- management responsibility;
- resource management;
- metrological confirmation and conduction of the measurement process;
- measurement management system, analysis and improvement; and
- interaction with customers and feedback.

As the essence of a Measurement Management System, **metrological confirmation** is a required set of operations to make sure that the measuring equipment meets requirements for the intended use.

This model makes possible

- to manage the risk that measurement processes and measuring equipment give wrong results in detriment of product quality,
- to guarantee that both the equipment and the processes are adequate for an intended use. If the system is effective, this is applicable to:
 - for measuring equipment used to prove compliance with specified requirements,
 - testing and calibration laboratories,
 - for suppliers whose Quality Management System uses measurement results to prove compliance with specified requirements,
 - for other organizations which use measurements to prove compliance with specified requirements.

Aspects related to management responsibility – i.e. human resources, information resources, records, identification and material resources – are approached from the same viewpoints and as profoundly as the ISO documents related to the aforesaid Management Systems. In this case, **metrological confirmation** is the distinguishing element of the process, and its fundamental principles can be summarized as follows:

- declaration that the equipment is fit for use, that is, already calibrated or verified, as applicable. Failure to meet this requirement makes confirmation impossible;
- identification of the equipment’s metrological characteristics, either on the basis of the manufacturer’s specifications or through experimental practice, since they must be checked within the framework of the process. For this reason, knowing the measurement requirements of the process whose quality needs to be guaranteed is also indispensable;
- satisfaction of the characteristics that guarantee the process requirements;
- checking of the expression of measurement results in SI units to guarantee uniformity and contribute to consumer protection;
- estimation of measurement uncertainty through every known source of measurement variability, in such a way that measurement quality can be established and its result subsequently compared with itself or a similar one;
- issuance of the relevant certificate stating the conditions under which this result was and will thereafter be achieved.

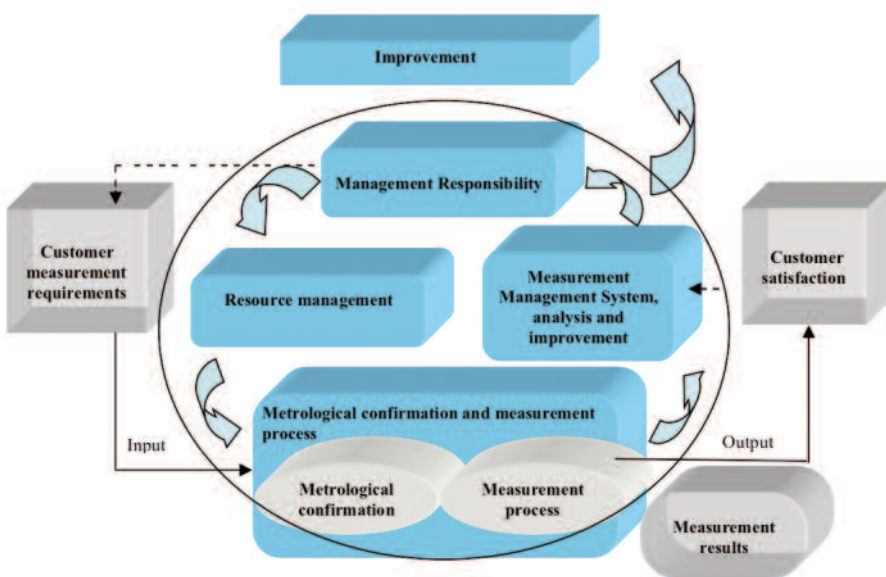

Figure 3 Measurement Management System model

Metrological confirmation is used by the organization in order to analyze the results of the various stages of the measurement process, identify opportunities for improvement and, therefore, reach higher quality levels.

Conclusions

A comprehensive analysis of Cuba's performance in metrological work in line with international regulations and guidelines provides evidence that our activity is consistent with the plans and projects imposed by globalization and our resolve to guarantee the **quality** of our measurements and, accordingly, all production, service, research and technological innovation processes involving the use of measurements, regardless of the limitations facing our country, which are mostly of an economic nature.

The proper assimilation of the above conceptual elements will directly benefit our level of qualification, as it will develop our intellectual and practical skills and therefore help us reach the quality goals laid down in the aforesaid projects.

Achieving reliable measurement results has a very clear and direct legal, economic, scientific and technological impact.

From the **legal** standpoint, they affect

- public guarantee,
- safety,
- official measurements, and
- consumer protection.

From the **economic** standpoint, they affect

- quality,
- ability to access and compete in the international market, and
- economic efficiency.

From the **scientific** and **technological** standpoint, they affect

- scientific development, and
- technological innovation. ■

Bibliography

- [1] NC-ISO/IEC 17025, Requisitos generales para la competencia de los laboratorios de ensayo y de calibración, 2006
- [2] OIML D 1: Considerations for a Law of Metrology, 2012
- [3] Decreto-Ley No. 183: De la Metrología, 1998 (in revision)
- [4] NC-OIML V 2: Vocabulario Internacional de Metrología - Conceptos Fundamentales y Generales y Términos Asociados (VIM), 2012
- [5] NC ISO: 9000: Sistemas de gestión de la calidad - Fundamentos y Vocabulario, 2005
- [6] Le Système International d'Unités / International System of Units, 8. edition, Bureau International des Poids et Mesures. Organisation Intergouvernementale de la Convention du Mètre, 2006
- [7] Decreto-Ley No.62: De la Implantación del Sistema Internacional de Unidades, 1982
- [8] Conférence Générale des Poids et Mesures (24. Réunion) Paris, October 17-21, 2011
- [9] JCGM 100:2008 *Guide to the Expression of Uncertainty in Measurement* (GUM 1995 with minor corrections), published by the OIML as OIML G 100:2008
- [10] Possolo A., Updating the guidelines for evaluating and expressing uncertainty of NIST measurement results. 7. Brazilian Congress of Metrology, November 24 to 27, 2013, Ouro Preto, Brazil
- [11] NC-ISO 10012: Sistemas de gestión de las mediciones. Requisitos para los procesos de medición y los equipos de medición, 2007

Author contact details

Ysabel Reyes Ponce

Instituto Nacional de Investigaciones en Metrología,
INIMET

Consulado 206 e/ Animas y Trocadero
Centro Habana
La Habana, Cuba

ysabel@inimet.cu / Tel: 864-3360 / Fax: 866-7696

REGIONAL NEWS

ASEAN Working Group on Legal Metrology meeting

M. KOCHSIEK, CIML-Past President
and PTB Consultant

C. SANETRA, PTB Consultant

The best practice in metrology law development for ASEAN Consultative Committee on Standards and Quality - Working Group on Legal Metrology (ACCSQ - WG 3)

Within the scope of the Physikalisch-Technische Bundesanstalt (PTB) technical cooperation project “Improving Quality Infrastructure in ASEAN”, PTB and the ASEAN Consultative Committee on Standards and Quality - Working Group on Legal Metrology (ACCSQ - WG 3) agreed to hold a workshop on June 2, 2014 in Siem Reap, Cambodia.

Since 2009, PTB has supported the ACCSQ and its Related Bodies through consultancy and technical trainings concerning quality infrastructure – a collective term for all measures that are necessary to prove the compliance of goods and services with the directives of the state for the protection of its citizens (based on technical regulations) or the compliance with the standards which are required by the customers. The workshop on *Best Practice In Metrology Law Development* supports the efforts of WG 3 towards a harmonized legal metrology legislation and administration in the region.

The objective of the workshop, which was conducted by three PTB experts Dr. Clemens Sanetra, Mr. Rainer Hahnwald and Dr. Manfred Kochsiek, was to seek a common understanding on best practices in developing metrology laws, particularly on how to build qualification and confidence in regulated areas. Topics which were addressed during the workshop are as follows:

- quality infrastructure in regulated and non-regulated areas,
- metrological infrastructure of a country based on international best practice with legal metrology as an important part thereof,
- analysis of selected existing laws, and
- international acceptance through OIML certification systems.

As a result of this activity, the ASEAN Member States (AMS) became more aware of the differences in handling and recognizing the procedures that concurrently exist within the region. The participants also jointly determined ways of building better confidence related to measurement activities among AMS, especially in regulated areas.

To provide more insight into the topics that were discussed, presentations were delivered by the PTB's experts and by representatives from Indonesia and Viet Nam.

In the first session, the issue of quality infrastructure on regulated and non-regulated areas was elaborated by Dr. Sanetra. This included:

- explanation and examples of state regulated areas which are mainly for protection purposes, and non-regulated areas that promote competitiveness and create added value for the economic development of a country;
- presentation of the quality infrastructure components, their functions and interactions in a systemic approach;
- national and international recognition processes in respect of legal metrology and scientific metrology;
- separation of tasks of bodies/institutions for legislation, execution and jurisdiction in good governance practice;
- roles of Legal Metrology Organizations (LMO) and National Measurement Institutes (NMI), as well as their interactions in regional and international metrological organizations.

In the second session, Dr. Kochsiek explained about the metrological infrastructure of a country based on international best practices – legal metrology as an important part. His presentation made reference to the structure and recommendations in OIML D 1 *Considerations for a Law on Metrology*, and at the same time complemented the statements from Dr. Sanetra's presentation. Important messages delivered were:

- the regulated area is much broader and deals with more challenges than the “classical legal metrology” activities, which focuses mainly on weighing instruments, fuel dispensers and utility meters. Nowadays, legal metrology responsibilities are extended into various fields such as in food safety, environmental protection, health care, etc.; they not only cover the mechanical parts but more and more the electronic and software parts;
- legal metrology is not an isolated issue but part of the national metrological infrastructure together with the NMI and a national coordination for metrology at government level;
- although tasks of legal metrology are a national issue, nowadays challenges through global trade require

more and more harmonization of criteria and implementation in the field of legal metrology;

- global harmonization of requirements is mostly completed, however the comparable implementation is not yet reaching satisfactory level. New options are more and more applied, such as through the conformity assessment bodies.

In the third session, the speakers invited the participants to discuss the status of metrology laws and their implementations in ASEAN:

- ▷ What needs to be regulated?
- ▷ How should the NMI and LMO be set up?
- ▷ Who should be the enforcement body?
- ▷ Who should be the service provider?
- ▷ Who is responsible for the legislation – lawmaker?
- ▷ Who is responsible for the execution – verifier?
- ▷ Who is responsible for jurisdiction – sanctions, fines..?

The results of the discussion based on the AMS inputs, and as concluded by the experts are listed below:

- there is no regional legislation in ASEAN on legal metrology (similar to that implemented in the EU);
- for some of the AMS, their national laws are still not fully harmonized;
- requirements and implementation procedures, especially for type approval processes differ from one AMS to another;
- harmonized regional recognition criteria and procedures within the ASEAN region do not exist.

Therefore:

- the mutual recognition of test results by the AMS (conformity declarations, type approval certificates) is required;
- confidence-building measures are necessary to resolve this issue whereby the peer review method is one of the best solutions to be considered.

Experiences gained in the revision of laws in the two AMS were shared. Firstly, Indonesia provided a guest speaker to present its experience on the current revision process for its Standards and Conformity Assessment Law and the preparation to revise its Metrology Law.

Indonesia is now revising laws and regulations related to national quality policy.

A new Law on Standardization and Conformity Assessment is now under final discussion in the Indonesian Parliament.

Provisions are included in the draft Law concerning the Government's provision of having an internationally recognized source of metrological traceability.

The provision includes the arrangement of a metrological infrastructure consisting of NMI, Calibration Service and Reference Materials Producers.

The planned revision of the existing Law on Legal Metrology is expected to complement the Law on Standardization and Conformity Assessment.

Harmonization among ASEAN countries of laws related to metrology, standardization and conformity assessment is needed as a fundamental basis for the ASEAN Economic Community (AEC).

During the following session, Viet Nam shared information on its newly developed metrology law, including the process of drafting and enacting the law on metrology, establishing legal metrology documents and developing and issuing technical regulation in metrology.

Lessons learnt from the two cases presented are that in some AMS, a coordinated metrological infrastructure is not yet implemented. The NMI and the LMO are

Introduction to the ASEAN Economic Community (AEC)

The ASEAN Leaders adopted the ASEAN Economic Blueprint at the 13th ASEAN Summit in November 2007 in Singapore to serve as a coherent master plan guiding the establishment of the ASEAN Economic Community 2015.

The ASEAN Economic Community (AEC) shall be the goal of regional economic integration by 2015. AEC envisages the following key characteristics: (a) a single market and production base, (b) a highly competitive economic region, (c) a region of equitable economic development, and (d) a region fully integrated into the global economy.

The AEC areas of cooperation include human resources development and capacity building; recognition of professional qualifications; closer consultation on macroeconomic and financial policies; trade financing measures; enhanced infrastructure and communications connectivity; development of electronic transactions through e-ASEAN; integrating industries across the region to promote regional sourcing; and enhancing private sector involvement for the building of the AEC. In short, the AEC will transform ASEAN into a region with free movement of goods, services, investment, skilled labour, and freer flow of capital.

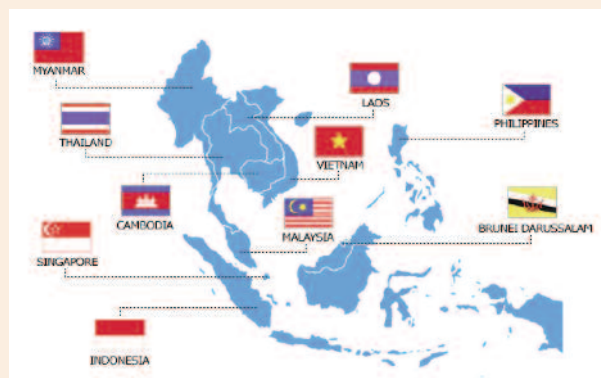

The ten ASEAN Economic Community Member Countries

working under different ministries and different provisions. The new approach following OIML D 1 establishes a coordinated metrological infrastructure, which assures collaboration and complementarity between NMI and LMO. Viet Nam achieved this approach through the recently established new metrology law and Indonesia is in the process of introducing this concept.

Following the presentations, the participants formed discussion groups on the following questions:

- i) A measuring instrument is being exported from one AMS to another AMS, one with a type approval certificate and one without a type approval certificate. What is the procedure?
- ii) Under which conditions should the AMS recognize type approval certificates from another AMS?
- iii) What are the criteria for mutual recognition of measurements among AMS?
- iv) How can confidence in measurements in regulated areas among AMS be improved?

Out of the discussion it became clear that due to the significant differences in the laws and implementation procedures, trust-building measures and mutual recognition procedures need to be developed and implemented to avoid duplications or gaps, e.g. in type approval processes.

The workshop also identified differences in the implementation of the various metrology laws and determined that type approval is not carried out in most of the AMS. This and the extensive deliberations by participants have indicated areas on which WG 3 should focus with high priority.

The main findings of this workshop indicated that in order to move forward and further harmonize legal metrology in ASEAN the following actions are required to be implemented:

- build up confidence in measurements in regulated areas between AMS;
- introduce harmonized type approval procedures for AMS;
- consider third party assessment for verification offices / laboratories, if necessary;
- introduce and implement “mandatory” regulations in ASEAN for legal metrology related activities such as introducing the ASEAN Directive on Legal Metrology.

As a first activity resulting from this workshop (to further support harmonization efforts), PTB offered to study the provisions in the existing metrology laws of the ten AMS and to objectively benchmark them against an international best practice, e.g. OIML D 1. Following the benchmarking more specific actions could be defined with WG 3.

One recommendation given to WG 3 members for their work plan is that the recognition and correct implementation of type approval certification should be given a high priority. As in any market, specifically within a single market environment, the large number of instruments used in the regulated area may have a huge negative impact, if it is not reliable and questionable. The correct approval process of measuring instruments will definitely reduce many anticipated market surveillance problems and disputes in the future.

Finally some recommendations were given for further harmonization measures, and for confidence-building measures. ■

Contact details:

Andrea Ulbrich (PTB Project Coordinator):
andrea.ulbrich@ptb.de

Dr. Wan Abd Malik Wan Mohamed (Chairman of
ACCSQ-WG 3): wanmalik@sirim.my



About 30 participants – legal metrology experts from the ASEAN Member States (AMS) discussed best practices for developing metrology laws.

Several ASEAN Member States are currently either in the process of or are considering revising their metrology laws.

Thus the Workshop aimed to better enable the AMS to take international good practices into account when revising their legislation.

OIML Systems

Basic and MAA Certificates registered

2014.06–2014.08

Information: www.oiml.org section “OIML Systems”

The OIML Basic Certificate System

The *OIML Basic Certificate System for Measuring Instruments* was introduced in 1991 to facilitate administrative procedures and lower the costs associated with the international trade of measuring instruments subject to legal requirements. The System, which was initially called “OIML Certificate System”, is now called the “OIML Basic Certificate System”. The aim is for “OIML Basic Certificates of Conformity” to be clearly distinguished from “OIML MAA Certificates”.

The System provides the possibility for manufacturers to obtain an OIML Basic Certificate and an OIML Basic Evaluation Report (called “Test Report” in the appropriate OIML Recommendations) indicating that a given instrument type complies with the requirements of the relevant OIML International Recommendation.

An OIML Recommendation can automatically be included within the System as soon as all the parts - including the Evaluation Report Format - have been published. Consequently, OIML Issuing Authorities may issue OIML Certificates for the relevant category from the date on which the Evaluation Report Format was published; this date is now given in the column entitled “Uploaded” on the Publications Page.

Other information on the System, particularly concerning the rules and conditions for the application, issue, and use of OIML Certificates, may be found in OIML Publication B 3 *OIML Basic Certificate System for OIML Type Evaluation of Measuring Instruments* (Edition 2011) which may be downloaded from the Publications page of the OIML web site. ■

The OIML MAA



In addition to the Basic System, the OIML has developed a *Mutual Acceptance Arrangement* (MAA) which is related to OIML Type Evaluations. This Arrangement - and its framework - are defined in OIML B 10 (Edition 2011) *Framework for a Mutual Acceptance Arrangement on OIML Type Evaluations*.

The OIML MAA is an additional tool to the OIML Basic Certificate System in particular to increase the existing mutual confidence through the System. It is still a voluntary system but with the following specific aspects:

- increase in confidence by setting up an evaluation of the Testing Laboratories involved in type testing,
- assistance to Member States who do not have their own test facilities,
- possibility to take into account (in a Declaration of Mutual Confidence, or DoMC) additional national requirements (to those of the relevant OIML Recommendation).

The aim of the MAA is for the participants to accept and utilize MAA Evaluation Reports validated by an OIML MAA Certificate of Conformity. To this end, participants in the MAA are either Issuing Participants or Utilizing Participants.

For manufacturers, it avoids duplication of tests for type approval in different countries.

Participants (Issuing and Utilizing) declare their participation by signing a Declaration of Mutual Confidence (Signed DoMCs). ■

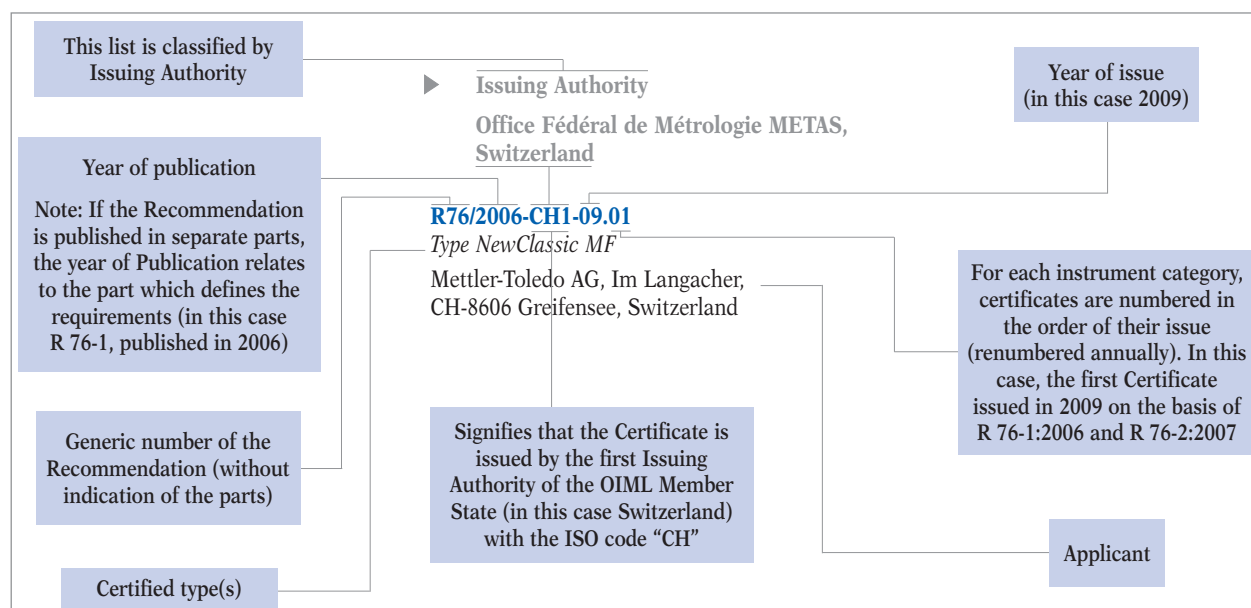

INSTRUMENT CATEGORY
CATÉGORIE D'INSTRUMENT

Water meters intended for the metering of cold potable water and hot water

Compteurs d'eau destinés au mesurage de l'eau potable froide et de l'eau chaude

R 49 (2006)

- ▶ Issuing Authority / *Autorité de délivrance*
Ministero dello sviluppo economico - Direzione generale mercato, concorrenza, consumatori, vigilanza e normativa tecnica, Italy

R049/2006-IT1-2014.01

Water meter intended for the metering of cold potable water and hot water - Type: PROMAG W800 (DN25 up DN800)

Endress + Hauser Flowtec AG, Kagenstrasse 7, CH-4153 Reinach BL 1, Switzerland

- ▶ Issuing Authority / *Autorité de délivrance*
National Measurement Office (NMO), United Kingdom

R049/2006-GB1-2007.01 Rev. 3

Family of cold-water meters utilising a common volumetric measuring element, with a nominal capacity of 36 revs/litre and having a rated permanent flowrate Q3 of 2.5 m³/h

Elster Metering Ltd., 130 Camford Way, Sundon Park, Luton LU3 3AN, United Kingdom

R049/2006-GB1-2008.01 Rev. 2 (MAA)

Family of cold-water meters utilising a common volumetric measuring element, with a nominal capacity of 13.2 revs/litre and having a rated permanent flowrate Q3 of 6.3 m³/h

Elster Metering Ltd., 130 Camford Way, Sundon Park, Luton LU3 3AN, United Kingdom

R049/2006-GB1-2009.01 Rev. 3 (MAA)

Family of cold-water meters utilising a common volumetric measuring element, with a nominal capacity of 16.5 revs/litre and having a rated permanent flowrate Q3 of 2.5 m³/h (R250) or 4.0 m³/h (R400)

Elster Metering Ltd., 130 Camford Way, Sundon Park, Luton LU3 3AN, United Kingdom

R049/2006-GB1-2010.04 Rev. 1 (MAA)

Family of cold-water meters utilising a common volumetric measuring element, with a nominal capacity of 5.5 revs/litre and having a rated permanent flowrate Q3 of 10 m³/h

Elster Metering Ltd., 130 Camford Way, Sundon Park, Luton LU3 3AN, United Kingdom

R049/2006-GB1-2010.05 Rev. 1

Family of cold-water meters, designated Octave, utilizing an ultrasonic measuring element and having a rated permanent flowrate Q3 between 40 m³/h and 1000 m³/h

Arat Ltd., Dalia - Ramot Menashe, POB19239 Dalia, Israel

R049/2006-GB1-2011.03 Rev. 2 (MAA)

Family of cold-water meters utilising a common volumetric measuring element, with a nominal capacity of 3.25 revs/litre and having a rated permanent flowrate Q3 of 10 m³/h or 16 m³/h

Elster Metering Ltd., 130 Camford Way, Sundon Park, Luton LU3 3AN, United Kingdom

R049/2006-GB1-2014.01

Family of cold-water meters, designated Q200, utilizing fluidic oscillator technology and having a rated permanent flowrate Q3 of 4.0 m³/h

Elster s.r.o., 8. aprila 259, SK-91601 Stara Tura, Slovakia

- ▶ Issuing Authority / *Autorité de délivrance*
Physikalisch-Technische Bundesanstalt (PTB), Germany

R049/2006-DE1-2008.02 Rev. 8

Water meter intended for the metering of cold potable water - Type: Q200 Q3=1.6 (E, P, M), Q200 Q3=2.5 (E, P, M), SM250 (E, P, M), SM700 (E, P, M)

Elster Metering Ltd., 130 Camford Way, Sundon Park, Luton LU3 3AN, United Kingdom

INSTRUMENT CATEGORY
CATÉGORIE D'INSTRUMENT

Automatic catchweighing instruments

Instruments de pesage trieurs-étiqueteurs à fonctionnement automatique

R 51 (2006)

- ▶ Issuing Authority / *Autorité de délivrance*
NMI Certin B.V., The Netherlands

R051/2006-NL1-2014.03

Automatic catchweighing instrument - Type: I-Series

Yamato Scale GmbH, Hanns-Martin-Schleyer Straße 13, DE-47877 Willich, Germany

R051/2006-NL1-2014.04

Automatic catchweighing instrument - Type: AW-5600, AW-560 CPR

Teraoka Seiko Co., Ltd., 13-12 Kugahara, 5-Chome, Ohta-ku, JP-146-8580 Tokyo, Japan

- ▶ Issuing Authority / *Autorité de délivrance*
National Measurement Office (NMO),
United Kingdom

R051/2006-GB1-2008.01 Rev. 0

CW3 Checkweigher

Loma Systems Group and ITW Group, Southwood, Farnborough GU14 0NY, United Kingdom

R051/2006-GB1-2008.01 Rev. 9

CW3 Checkweigher

Loma Systems Group and ITW Group, Southwood, Farnborough GU14 0NY, United Kingdom

R051/2006-GB1-2009.04 Rev. 2

VersaWeigh, VersaGP, Versa RxC, Versa RxM and Teorema Checkweighers

Thermo Ramsey Italia S.R.L., Strada Rivoltana km 6/7, IT-20090 Rodano (MI), Italy

INSTRUMENT CATEGORY

CATÉGORIE D'INSTRUMENT

Metrological regulation for load cells (applicable to analog and/or digital load cells)

*Réglementation métrologique des cellules de pesée
(applicable aux cellules de pesée à affichage
analogique et/ou numérique)*

R 60 (2000)

- ▶ Issuing Authority / *Autorité de délivrance*
NMI Certin B.V.,
The Netherlands

R060/2000-NL1-2014.05 (MAA)

Single point load cell, with strain gauges - Type: WL 1022

Acecells Instruments (ZJ) Co. Ltd., No. 123 Zhenning West Road, Jiaochuan Street, Zhenhan District, Ningbo, P.R. China

R060/2000-NL1-2014.06 (MAA)

Single point load cell, with strain gauges - Type: WL1260 and WL1263

Acecells Instruments (ZJ) Co. Ltd., No. 123 Zhenning West Road, Jiaochuan Street, Zhenhan District, Ningbo, P.R. China

R060/2000-NL1-2014.07 (MAA)

Single point load cell, with strain gauges - Type: WL1241, WL1243 and WL 1245

Acecells Instruments (ZJ) Co. Ltd., No. 123 Zhenning West Road, Jiaochuan Street, Zhenhan District, Ningbo, P.R. China

R060/2000-NL1-2014.10

Bending beam load cell, with strain gauges, equipped with electronics - Type: FIT/5

Hottinger Baldwin Messtechnik GmbH, Im Tiefen See 45, DE-64293 Darmstadt, Germany

R060/2000-NL1-2014.12 (MAA)

Shear beam load cell, with strain gauges - Type: SBO-A

Digi-Star L.L.C., W5527 Hwy 106, 53538 Fort Atkinson, WI, United States

R060/2000-NL1-2014.13 (MAA)

Bending beam load cell, with strain gauges - Type: PA08R, PA08G and PA08L

Shekel Electronics Scales, Kibbutz Beit Keshet, IL-M.P. Lower Galilee 15247, Israel

- ▶ Issuing Authority / *Autorité de délivrance*
National Measurement Office (NMO),
United Kingdom

R060/2000-GB1-2011.02 Rev. 2 (MAA)

MS S-type stainless steel compression and tension load cell

Zhejiang South-Ocean Sensor Manufacturing Co., Ltd, N° 58, Nanyang Road, Qianyuan Town, Deqing County, CN-313216 Huzhou City, Zhejiang Province, P.R. China

- ▶ Issuing Authority / *Autorité de délivrance*
Physikalisch-Technische Bundesanstalt (PTB),
Germany

R060/2000-DE1-2014.01

Compression load cell - Type: PR 6201

Sartorius Mechatronics T&H GmbH, Meiendorfer Strasse 205, DE-22145 Hamburg, Germany



INSTRUMENT CATEGORY
CATÉGORIE D'INSTRUMENT

Nonautomatic weighing instruments
Instruments de pesage à fonctionnement non automatique

R 76-1 (1992), R 76-2 (1993)

- Issuing Authority / *Autorité de délivrance*
NMI Certin B.V.,
The Netherlands

R076/1992-NL1-2011.14 Rev. 1

Non-automatic weighing instrument - Type: PCS
Grupo Epelsa S.L., c/Punto Net, 3, Polígono Industrial
TECNOALCALÁ, 28805 Alcalá de Henares (Madrid),
Spain

R076/1992-NL1-2014.29

Non-automatic weighing instrument - Type: PS-series
Snowrex International Co., Ltd., 2F No. 9, Lane 50, Sec. 3,
Nan-Kang Road, Taiwan-Taipei, Chinese Taipei

R076/1992-NL1-2014.36

*Non-automatic weighing instrument - Type: Total Care Scale
(P1900, P1840, 135266, 150298, 1900V)*
Hill-Rom, 1069 State Route 46 East, 47006 Batesville,
Indiana, United States

- Issuing Authority / *Autorité de délivrance*
National Measurement Office (NMO),
United Kingdom

R076/1992-GB1-2010.04 Rev. 3 (MAA)

SW Series
CAS Corporation, #262, Geurugogae-ro, Gwangjeok-
myeon, Yangju-si, Gyeonnggi-do, Rep. of Korea

INSTRUMENT CATEGORY
CATÉGORIE D'INSTRUMENT

Non-automatic weighing instruments
Instruments de pesage à fonctionnement non automatique

R 76-1 (2006), R 76-2 (2007)

- Issuing Authority / *Autorité de délivrance*
NMI Certin B.V.,
The Netherlands

R076/2006-NL1-2010.13 Rev. 2

*Non-automatic weighing instrument - Type: 830x/840x
(where x represents a number from 0 to 9)*
Datalogic ADC, Inc, 959 Terry Street, 97402 Eugene,
OR, United States

R076/2006-NL1-2012.06 Rev. 1 (MAA)

Non automatic weighing instrument - Type: ICS.
Mettler-Toledo (Albstadt) GmbH, Unter dem
Malesfelden 34, DE-72458 Albstadt, Germany

R076/2006-NL1-2014.02 (MAA)

Non-automatic weighing instrument - Type: AB, RJ
Shinko Denshi Co., Ltd, 3-9-11 Yushima, Bunkyo-ku,
JP-113-0034 Tokyo, Japan

R076/2006-NL1-2014.02 Rev. 1 (MAA)

Non-automatic weighing instrument - Type: AB, RJ
Shinko Denshi Co., Ltd, 3-9-11 Yushima, Bunkyo-ku,
JP-113-0034 Tokyo, Japan

R076/2006-NL1-2014.22 (MAA)

Non-automatic weighing instrument - Type: bRite
Mettler-Toledo (Changzhou) Measurement Technology
Ltd, N° 111, West TaiHu Road, ChangZhou XinBei
District, CN-213125, Jiangsu, P.R. China

R076/2006-NL1-2014.25 (MAA)

Non-automatic weighing instrument - Type: HE
Mettler-Toledo Instrument (Shanghai) Co., Ltd,
589 GuiPing Road, Shanghai 200233, P.R. China

R076/2006-NL1-2014.25 Rev. 1 (MAA)

*Non-automatic weighing instrument - Type: HE. . .
Moisture analyzer*
Mettler-Toledo Instrument (Shanghai) Co., Ltd,
589 GuiPing Road, Shanghai 200233, P.R. China

R076/2006-NL1-2014.26 (MAA)

Non-automatic weighing instrument - Type: BM5
Balancas Marques de Jose Pimienta Marques, Ltda.,
Parque Industrial de Celeiros (2a Fase), Apartado 2376,
4701-905 Braga, Portugal

R076/2006-NL1-2014.27 (MAA)*Indicator - Type: LP-500*Dibal S.A, Astinze Kalea,, 24-Pol. Ind. Neinver,
ES-48160 Derio (Bilbao-Vizcaya), Spain**R076/2006-NL1-2014.28 (MAA)***Indicator - Type: XK3118T4*Keli Sensing Technology (Ningbo) Co., Ltd., No. 199 of
Changxing RD, Jiangbei district, Ningbo, P.R. China**R076/2006-NL1-2014.30 (MAA)***Non-automatic weighing instrument - Type: DPS-5600*Teraoka Seiko Co., Ltd., 13-12 Kugahara, 5-Chome,
Ohta-ku, JP-146-8580 Tokyo, Japan**R076/2006-NL1-2014.31 (MAA)***Non-automatic weighing instrument - Type, AW-5600,
AW5600CP, AW-5600CPR, AW-5600FX*Teraoka Seiko Co., Ltd., 13-12 Kugahara, 5-Chome,
Ohta-ku, JP-146-8580 Tokyo, Japan**R076/2006-NL1-2014.32 (MAA)***Non-automatic weighing instrument - Type: SM-5000,
SM-5300, SM-5400, SM-5500, SM-5500H*Teraoka Weigh-System PTE Ltd, 4 Leng Kee Road,
#05-03/04/05 & 11, SIS Building, SG-159088 Singapore**R076/2006-NL1-2014.33 (MAA)***Indicator or analog data processing device -**Type: ITx000E-. . . , Type: ITx000ET-. . . , Type: ITx000M-. . .
..(x=3, 4, 6 or 8)*SysTec Systemtechnik und Industrieautomation GmbH,
Ludwig-Erhard-Str. 6, DE-50129 Bergheim, Germany**R076/2006-NL1-2014.38 (MAA)***Indicator - Type: DI-770*Shanghai Teraoka Electronic Co., Ltd., Tinglin Industry
Developmental Zone, Jin Shan District,
CN-201505 Shanghai, P.R. China► **Issuing Authority / Autorité de délivrance****National Measurement Office (NMO),
United Kingdom****R076/2006-GB1-2012.04 Rev. 2 (MAA)***ZM301, ZM303, ZM305 and ZQ375 Series*Avery Weigh-Tronix, Foundry Lane, Smethwick B66 2LP,
United Kingdom**R076/2006-GB1-2012.05 Rev. 2 (MAA)***ZQ375 Checkweigher*Avery Weigh-Tronix, Foundry Lane, Smethwick B66 2LP,
United Kingdom**R076/2006-GB1-2012.09 Rev. 1 (MAA)***LI-700E*Digi Europe Ltd, Digi House, Rookwood Way, Haverhill,
Suffolk CB9 8DG, United Kingdom**R076/2006-GB1-2013.02 (MAA)***ZM201, ZM205 Series*Avery Weigh-Tronix, Foundry Lane, Smethwick B66 2LP,
United Kingdom**R076/2006-GB1-2014.03 (MAA)***FJ3-XXX, GJW-XXXX, HJW-XXX OR HJP-XXX Hanging
scales where XXXX denotes alternative approved models.*Excell Precision Co. Ltd., 6F, No. 127, Lane 235,
Pao-Chiao Road, Hsin Tien, TW-Taipei Hsien,
Chinese Taipei**R076/2006-GB1-2014.05 (MAA)***CI-600 Series*CAS Corporation, #262, Geurugogae-ro, Gwangjeok-
myeon, Yangju-si, Gyeonggi-do, Rep of Korea**R076/2006-GB1-2014.08 (MAA)***DD700, DD700IC and DD700I*Societa Cooperativa Bilanciai Campogalliano a.r.l,
Via S. Ferrari, 16, IT-41011 Campogalliano (Modena),
Italy► **Issuing Authority / Autorité de délivrance****Physikalisch-Technische Bundesanstalt (PTB),
Germany****R076/2006-DE1-2012.02***Non-automatic, electromechanical price-computing
weighing instrument for direct sales to the public -
Type: XC . . .*Bizerba GmbH & Co. KG, Wilhelm-Kraut-Strasse 65,
DE-72336 Balingen, Germany**R076/2006-DE1-2012.03 Rev. 2***Non automatic electromechanical weighing instrument -
Type: SQP*Sartorius Weighing Technology GmbH, Weender
Landstrasse 94-108, DE-37075 Gottingen, Germany**R076/2006-DE1-2014.01***Nonautomatic electromechanical weighing instrument -
Type: MSX*Sartorius Scientific Instruments (Beijing) Co., Limited,
Tianzhu Airport Industrial Zone, Yu An Road No. 33,
Zone B, 101300 Beijing, P.R. China

INSTRUMENT CATEGORY
CATÉGORIE D'INSTRUMENT

Automatic level gauges for fixed storage tanks
Jaugeurs automatiques pour les réservoirs de stockage fixes

R 85 (2008)

- ▶ Issuing Authority / *Autorité de délivrance*
National Measurement Office (NMO),
United Kingdom

R085/2008-GB1-2009.01 Rev. 1

Family of probes and consoles used for measuring the level of fuel, or other liquids, in storage tanks
Gilbarco Veeder Root, Crompton Close, Basildon,
Essex SS14 3BA, United Kingdom

INSTRUMENT CATEGORY
CATÉGORIE D'INSTRUMENT

Instruments for measuring vehicle exhaust emissions

Instruments de mesure des gaz d'échappement des véhicules

R 99 (2008)

- ▶ Issuing Authority / *Autorité de délivrance*
NMI Certin B.V.,
The Netherlands

R099/2008-NL1-2014.01

Exhaust gas analyzer - Brand: Motorscan - Type: Totalgas 8050-AN
EOS S.R.L., Via Monte Aquila, 2, IT-43124 Parma, Italy

INSTRUMENT CATEGORY
CATÉGORIE D'INSTRUMENT

Automatic rail-weighbridges
Ponts-bascules ferroviaires à fonctionnement automatique

R 106 (1997)

- ▶ Issuing Authority / *Autorité de délivrance*
National Measurement Office (NMO),
United Kingdom

R106/1997-GB1-2007.01 Rev. 3

Railweight TSR4000
Avery Weigh-Tronix, Foundry Lane, Smethwick B66 2LP,
United Kingdom

INSTRUMENT CATEGORY
CATÉGORIE D'INSTRUMENT

Fuel dispensers for motor vehicles

Distributeurs de carburant pour véhicules à moteur

R 117 (1995) + R 118 (1995)

- ▶ Issuing Authority / *Autorité de délivrance*
State General Administration for Quality Supervision and Inspection and Quarantine (AQSIQ), China

R117/1995-CN1-2013.01

Fuel dispenser - Type: ZC-11111, ZC-11122, ZC-22222
Zhejiang Genuine Machine Co., Ltd., Special Industrial Park Puqi Yueqing, 325609 Zhejiang, P.R. China

- ▶ Issuing Authority / *Autorité de délivrance*
National Measurement Office (NMO),
United Kingdom

R117/1995-GB1-2014.01

Liquids other than water, Encore family
Gilbarco Veeder Root, Crompton Close, Basildon,
Essex SS14 3BA, United Kingdom

The OIML is pleased to welcome the following new

■ CIML Members

- **Bulgaria:**
Mr. Dimitar Stankov
- **Cyprus:**
Mr. Ionnis Economides
- **Turkey:**
Prof. Dr. Necip Camuscu
- **Zambia:**
Mr. Benjamin Musonda

■ OIML meetings

November 2014

49th CIML Meeting and Associated Events
3-6 November - Auckland, New Zealand

December 2014

TC 8/SC 1/p 6: Revision of R 80
Date to be confirmed - Braunschweig, Germany

Bulletin online:

Download the OIML Bulletin
free of charge

oiml.org/en/publications/bulletin

www.oiml.org
Stay informed



www.metrologyinfo.org
Joint BIPM-BIML Web Portal

■ Committee Drafts

Received by the BIML, 2014.06 – 2014.09

Revision of OIML R 61 Automatic gravimetric filling instruments. Part 1: Metrological and technical requirements - Tests, and Part 2: Test report format	E	4 CD	TC 9/SC 2	UK
Revision of OIML R 60-1 Metrological regulation for load cells. Part 1: Metrological and technical requirements	E	3 CD	TC 9	US
Protein measuring instruments for cereal grain and oil seeds	E	5 CD	TC 18/SC 8	AU
Guidance for defining the system requirements for a certification system for prepackages	E	1 CD	TC 6/p 5	ZA



OIML BULLETIN

VOLUME LV • NUMBER 4
OCTOBER 2014

Quarterly Journal

Organisation Internationale de Métrologie Légale

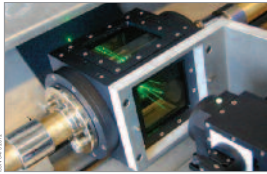

Investigation and characterization of water meter behavior under different flow conditions

Call for papers

OIML Members

RLMOs

Liaison Institutions

Manufacturers' Associations

Consumers' & Users' Groups, etc.



OIML BULLETIN

VOLUME LV • NUMBER 2/3
APRIL/JULY 2014

Quarterly Journal

Organisation Internationale de Métrologie Légale



World Metrology Day 2014: Measurements and the global energy challenge

- Technical articles on legal metrology related subjects
- Features on metrology in your country
- Accounts of Seminars, Meetings, Conferences
- Announcements of forthcoming events, etc.



OIML BULLETIN

VOLUME LV • NUMBER 1
JANUARY 2014

Quarterly Journal

Organisation Internationale de Métrologie Légale



OIML meets in Ho Chi Minh City, Viet Nam for its 48th meeting

The **OIML Bulletin** is a forum for the publication of technical papers and diverse articles addressing metrological advances in trade, health, the environment and safety - fields in which the credibility of measurement remains a challenging priority. The Editors of the Bulletin encourage the submission of articles covering topics such as national, regional and international activities in legal metrology and related fields, evaluation procedures, accreditation and certification, and measuring techniques and instrumentation. Authors are requested to submit:

- a titled, typed manuscript in Word or WordPerfect either on disk or (preferably) by e-mail;
- the paper originals of any relevant photos, illustrations, diagrams, etc.;
- a photograph of the author(s) suitable for publication together with full contact details: name, position, institution, address, telephone, fax and e-mail.

Note: Electronic images should be minimum 150 dpi, preferably 300 dpi.

Technical articles selected for publication will be remunerated at the rate of 23 € per printed page, provided that they have not already been published in other journals. The Editors reserve the right to edit contributions for style, space and linguistic reasons and author approval is always obtained prior to publication. The Editors decline responsibility for any claims made in articles, which are the sole responsibility of the authors concerned. Please send submissions to:

The Editor, OIML Bulletin
BIML, 11 Rue Turgot, F-75009 Paris, France
(chris.pulham@oiml.org)



OIML BULLETIN

VOLUME LV • NUMBER 4
OCTOBER 2013

Quarterly Journal

Organisation Internationale de Métrologie Légale



The new www.oiml.org revealed