

# BULLETIN

DE

L'ORGANISATION

INTERNATIONALE

DE MÉTROLOGIE LÉGALE

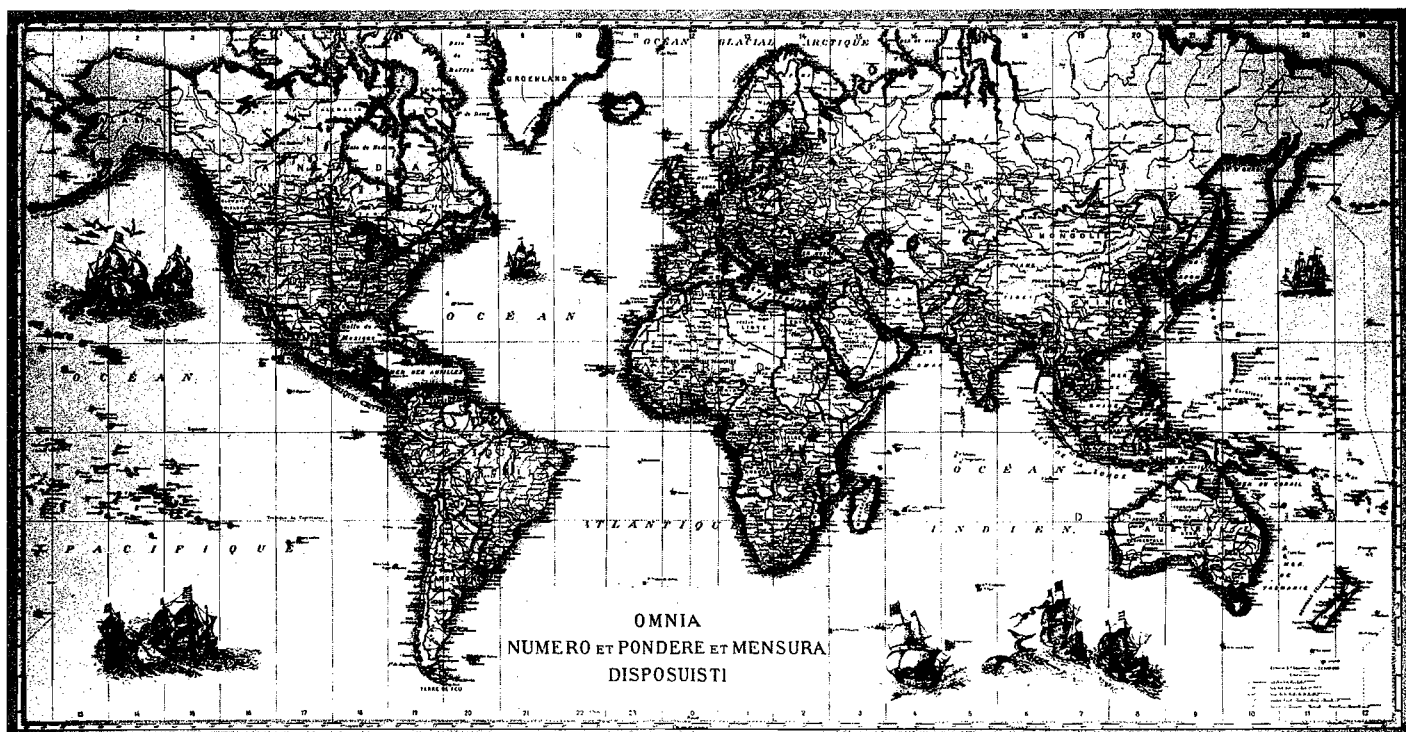

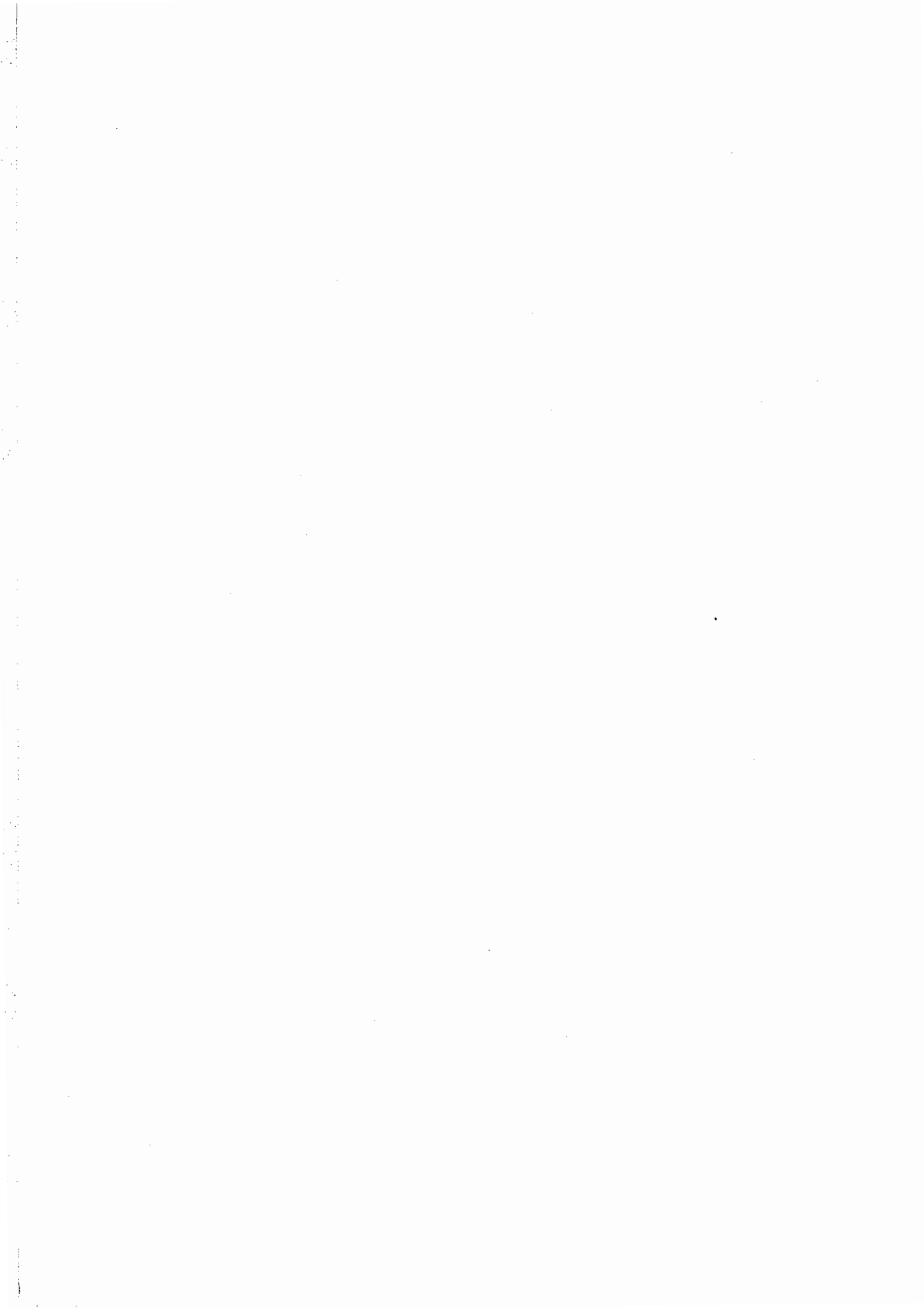

**BULLETIN**  
**de**  
**L'ORGANISATION INTERNATIONALE de MÉTROLOGIE LÉGALE**

**SOMMAIRE**

	Pages
Vingt-sixième réunion du CIML .....	3
Relations entre l'OIML et l'industrie de fabrication d'instruments de mesure .....	4
Twenty-sixth meeting of CIML .....	5
Relations between OIML and industries manufacturing measuring instruments .....	6
ALLEMAGNE – Metrological control of medical measuring instruments by E. SEILER .....	7
ALLEMAGNE – Non-invasive blood pressure measurement by S. MIEKE .....	18
AUTRICHE – Theory and simulation of oscillometric blood pressure measurements by H. TÖMBÖL .....	30
AUSTRALIE – Pattern approval and verification of a vapour recovery flow metering system by I. HOERLEIN .....	41
 <b>INFORMATIONS</b>	
Membres du CIML .....	51
Système de Certificats OIML .....	53
Réglementation dans les pays de la CEE et AELE .....	55
Regulations in the countries of EEC and EFTA .....	56
OIML seminar Clean Air Measurement .....	57
Workshop on medical measuring instruments .....	59
Réunions OIML Meetings .....	60
 <b>DOCUMENTATION</b>	
Publications .....	61
États membres de l'Organisation Internationale de Métrologie Légale .....	69
Membres actuels du Comité International de Métrologie Légale .....	70
Adresses des Services des Membres Correspondants .....	75

Abonnement pour 1992 : Europe : 200 F-français  
Autres pays : 250 F-français  
Chèques postaux : Paris 8 046-24 X  
Banque de France : B.P. 140-01 - 75049 Paris Cedex 01  
Comptes Courants, Banques Étrangères, Compte n° 5051-7

**BUREAU INTERNATIONAL DE MÉTROLOGIE LÉGALE**  
11, Rue Turgot – 75009 Paris – France  
Tél. 33 1 48 78 12 82 Le Directeur : Mr B. ATHANÉ  
et 42 85 27 11 Téléfax : 33 1 42 82 17 27  
Télex : 234 444 SVP SERV F ATTN OIML

## Editorial

La métrologie légale est, dans bien des pays, concentrée sur les instruments utilisés dans les transactions commerciales.

Les mesurages dans les domaines de la santé et de la sécurité des personnes exigent cependant des efforts croissants afin d'assurer un fonctionnement correct des instruments auquel les utilisateurs, et en particulier les autorités médicales, peuvent se fier.

Thermomètres médicaux et instruments de mesure de la pression sanguine furent parmi les premières Recommandations de l'OIML qui sont actuellement en cours d'être complétées afin de tenir compte des développements électroniques.

Ce Bulletin contient des articles dans ce domaine, dans le but particulier d'expliquer en détail le principe de fonctionnement et l'essai des instruments de mesure de la pression sanguine basés sur la méthode oscillométrique.

Les deux premiers de ces articles ont été présentés lors d'un cours de formation en Allemagne en 1991, qui sera répété en 1992, voir page 59.

*Legal metrology is in many countries concentrated on instruments used for commercial transactions.*

*Measurements in the field of public health and safety require however increasing efforts to ensure correct instrument performance on which users and in particular the medical authorities can rely.*

*Clinical thermometers and blood pressure measuring instruments were among the first Recommendations issued by OIML and are presently being completed to take into account electronic developments.*

*This issue of the Bulletin contains articles in this field with the particular aims of explaining in detail the principle of operation and testing of oscillometric blood pressure measuring instruments.*

*The first two of these articles formed part of a training course in the Federal Republic of Germany in 1991 which will be repeated in 1992, see announcement on page 59.*

*Correction: The legend to Table 1, page 8 in Bulletin N° 124, September 1991 should read "Official regulations and controls of clinical thermometers and sphygmomanometers".*

## **VINGT-SIXIÈME RÉUNION DU COMITÉ INTERNATIONAL DE MÉTROLOGIE LÉGALE**

Le Comité International de Métrologie Légale (CIML) a tenu sa vingt-sixième réunion à Paris, du 7 au 9 octobre 1991. Sur les 49 États Membres de l'OIML 40 étaient représentés par une soixantaine de participants dont certains avaient également assisté à la Conférence Générale des Poids et Mesures tenue la semaine précédente également à Paris.

Parmi les décisions importantes du Comité, on notera tout d'abord l'élection du Professeur M. Kochsiek, Directeur à la Physikalisch-Technische Bundesanstalt (Allemagne) comme Vice-Président du CIML. Le CIML a également élu comme Adjoint au Directeur du BIML, Monsieur Ph. Degavre, Ingénieur à l'Inspection Générale de Métrologie de Belgique, qui prendra ses fonctions en octobre 1992.

Le Comité a pris connaissance des travaux menés par le BIML en étroite consultation avec tous les États Membres, pour revoir les procédures de travail techniques de l'OIML, améliorer la présentation et la rédaction des Recommandations Internationales et reconsidérer l'ensemble du programme technique de l'OIML pour mieux le concentrer sur les tâches prioritaires. Dans l'établissement des nouvelles procédures et des règles de présentation et de rédaction des Recommandations de l'OIML, le BIML s'était largement inspiré des Directives récemment mises au point en commun par l'ISO et la CEI.

A l'issue des discussions, le Comité a donné des directives au BIML pour l'aboutissement de ces travaux.

Trois nouvelles Recommandations Internationales ont été approuvées dans les domaines de l'acoustique et des vibrations, ainsi qu'une révision de la Recommandation R 76 sur les instruments de pesage à fonctionnement non automatique.

Le Comité a par ailleurs pris note des progrès effectués dans la mise sur pied des organes nationaux chargés de faire fonctionner le Système de Certificats OIML (des informations sur ce système sont d'ailleurs périodiquement données dans le Bulletin); le Comité a appris que les premiers certificats OIML devraient être délivrés vers la fin de l'année 1991.

Des rapports sur l'organisation de cours de formation destinés en particulier à des techniciens de pays en développement (cours pour lesquels le BIML a été autorisé à engager des fonds sur le budget réservé à l'activité en faveur des pays en développement), ainsi que sur un séminaire technique sur les instruments de mesure de la pollution de l'air, ont reçu le plein soutien des Membres du CIML. Le Comité a par ailleurs pris note avec intérêt du développement des relations entre l'OIML et diverses institutions internationales ou régionales à buts connexes (en particulier la CEI et l'ISO, qui au même moment tenaient à Madrid le premier Sommet Mondial de la Normalisation, et des organes européens de normalisation, CEN et CENELEC, dont l'activité dans le domaine de la métrologie va en se développant).

Le Comité a également discuté des relations entre l'OIML et les constructeurs d'instruments de mesure. On trouvera ci-après une note à ce sujet.

Le Comité a enfin décidé de tenir sa vingt-septième réunion en novembre 1992, en Grèce, à l'occasion de la neuvième Conférence Internationale de Métrologie Légale, et sa vingt-huitième réunion en 1993 à Berlin.

## **Relations entre l'OIML et l'industrie de fabrication d'instruments de mesure**

Même si la plupart des activités de l'OIML sont menées par les fonctionnaires gouvernementaux chargés, dans leur pays, des activités de métrologie légale, l'OIML constitue aussi un forum dans lequel toutes les autres parties intéressées par la réglementation des instruments de mesure peuvent également participer, s'exprimer et contribuer aux décisions finales.

Parmi ces parties, la plus concernée est certainement celle constituée par les fabricants d'instruments de mesure qui doivent satisfaire aux exigences de performances fixées par les réglementations nationales et harmonisées par les Recommandations Internationales de l'OIML.

Depuis sa création, l'OIML s'est efforcé d'associer pleinement tous les fabricants intéressés à ses travaux techniques.

Cette participation prend deux formes:

- au niveau d'un pays, les constructeurs peuvent participer aux groupes de travail nationaux chargés de définir l'attitude du pays vis-à-vis de tel ou tel projet de Recommandation OIML,
- au niveau régional ou international, les associations de constructeurs peuvent, sur leur demande, être admises comme institutions en liaison au sein des groupes de travail OIML qui les concernent.

Mais l'intérêt des constructeurs ne se limite pas à participer aux travaux de l'OIML pour indiquer ce qui est techniquement possible et assurer que les Recommandations de l'OIML sont effectivement écrites en termes de performances métrologiques à atteindre et non en termes de solutions techniques et exigences de conception. Une fois qu'une Recommandation OIML est publiée, il est en effet dans l'intérêt des constructeurs qu'elle soit effectivement mise en application dans les réglementations nationales des États Membres.

C'est dans ce contexte que le Comité International de Métrologie Légale, lors de sa vingtième réunion, a pris connaissance d'une lettre du CECIP (Comité Européen de Constructeurs d'Instruments de Pesage) abordant ces questions.

A l'issue des discussions, le Comité s'est félicité de l'intention des constructeurs membres du CECIP d'inciter leurs autorités nationales à rapidement mettre en application les Recommandations OIML dans les réglementations nationales.

Le Comité a rappelé qu'à plusieurs reprises dans le passé il avait demandé à ses Membres d'associer étroitement les constructeurs aux travaux techniques de l'OIML, comme cela est clairement précisé dans le "Guide à l'intention des Membres du CIML" et il a demandé que les modalités de cette participation soient bien précisées dans les futures directives pour les travaux techniques de l'OIML.

Le Comité a enfin rappelé que la politique de travail de l'OIML vise clairement à la publication de Recommandations écrites en termes de performances métrologiques à atteindre et de méthodes d'essai, et non en termes d'exigences sur la conception des instruments, qui risqueraient de freiner l'innovation dans ce domaine.

## **TWENTY-SIXTH MEETING OF THE INTERNATIONAL COMMITTEE OF LEGAL METROLOGY**

The International Committee of Legal Metrology (CIML) held its twenty-sixth meeting in Paris from the 7th to the 9th October 1991. Of the 49 Member States of OIML, 40 were represented by about 60 people, some of whom had also attended the General Conference on Weights and Measures in Paris the preceding week.

Among the Committee's more important decisions is to be noted first the election of Professor M. Kochsiek, Director of the Physikalisch-Technische Bundesanstalt (Germany), as Vice-President of CIML. The CIML also elected Mr Ph. Degavre, Ingénieur at the Belgian Inspection Générale de Métrologie, as Assistant to the Director of BIML; he will take up his duties in October 1992.

The Committee took note of BIML's proposals, developed in close consultation with all the Member States, to revise the procedures for the technical work of OIML, to improve the drafting and presentation of its International Recommendations, and to reconsider the entire technical work programme of OIML in order to concentrate more on the tasks of highest priority. In developing the new procedures BIML has drawn largely on the Directives recently adopted in common by ISO and IEC.

Following a discussion the Committee gave instructions to BIML for the completion of the work.

Three new International Recommendations in the fields of acoustics and vibration were approved, in addition to a revision of R 76 on nonautomatic weighing instruments.

The Committee also took note of progress made in the establishment of national bodies responsible for the operation of the OIML Certificate System (information about the system is given periodically in the Bulletin); the Committee learned that the first OIML certificates would be issued towards the end of 1991.

A report on the organization of training courses aimed especially at technicians from the developing countries, for which BIML was authorized to draw on the budget for activities in support of such countries, received the Committee's full support; the Committee also heard and approved an account of preparations for a technical seminar on instruments for the measurement of air pollution. The Committee noted with interest the development of relations between OIML and various international and regional institutions whose objectives are related to its own, in particular IEC and ISO, who were at the same moment holding the first World Summit on Standardization in Madrid, and the European standards bodies, CEN and CENELEC, who are increasingly active in the metrological field.

The Committee also discussed relations between OIML and manufacturers of measuring instruments (a note on that topic is appended).

Finally the Committee decided to hold its twenty-seventh meeting in Greece in November 1992 on the occasion of the Ninth International Conference of Legal Metrology, and its twenty-eighth meeting in Berlin in 1993.

## **Relations between OIML and industries manufacturing measuring instruments**

Though most of its work is the responsibility of the government officials in charge of legal metrology in its Member States, OIML also constitutes a forum in which all parties having an interest in the regulation of measuring instruments may express their views and thus contribute to and take part in the final decisions.

Among those parties the most concerned is certainly that constituted by the manufacturers of measuring instruments, which must satisfy the performance requirements laid down in national regulations and unified by OIML International Recommendations.

Ever since its creation OIML has made great efforts to bring all interested manufacturers into full association with its technical work.

That participation takes two forms:

- within a country, manufacturers may join national working groups, each of which is responsible for the formation of a national viewpoint on this or that draft OIML Recommendation,
- regional or international associations of manufacturers may be admitted at their request as liaising institutions to the OIML working groups that concern them.

But the manufacturers' interest is not limited to participating in the work to indicate what is technically possible and to ensure that OIML Recommendations are written in terms of the metrological performance to be achieved, and not of technical solutions and design requirements. Once an OIML Recommendation has been published, it is in the manufacturers' interest that it be applied in the national regulations of the Member States.

It was in that context that the International Committee of Legal Metrology, at its twenty-sixth meeting, took note of a letter from CECIP (Comité Européen de constructeurs d'Instruments de Pesage - European committee of weighing-machine manufacturers) that addressed those matters.

After a discussion the Committee expressed its satisfaction with the intentions of the manufacturers to apply pressure on the national authorities to put OIML Recommendations into effect quickly.

The Committee recalled that on a number of occasions it had asked its Members to associate manufacturers closely with the technical work of OIML, as was clearly stated in the "Guide for Members of CIML", and it asked that the manner of such participation be clearly stated in the future directives for the technical work of OIML.

Finally the Committee reiterated that the working policy of OIML aimed clearly at the publication of Recommendations written in terms of metrological performance and methods of test, and not in terms of design requirements for instruments, for that could be a restraint on innovation.



## **METROLOGICAL CONTROL OF MEDICAL MEASURING INSTRUMENTS\***

by **Eberhard SEILER**

Physikalisch-Technische Bundesanstalt

### **1. Present situation**

Technical progress has opened up new possibilities also for the doctors. For diagnosis and therapy, they no longer depend on their sensory impressions and their experience, but they can obtain detailed information about bodily functions by using highly sensitive methods of measurement and analysis. Measurements often reveal changes already at a very early stage when there are not yet any visible symptoms.

The doctors' actions are therefore increasingly influenced by measurements. Modern hospitals have large measuring and analysing systems at their disposal, but every general practitioner also uses measuring instruments as he must at least be in a position to measure the body temperature and the blood pressure.

Measurements and analyses are therefore important aids in diagnosis and therapy. Many novel therapeutical methods, for example, the application of radioactive radiation, are not possible without precise measurements, for too high a dose is detrimental and too low a dose does not produce the desired results. It must therefore be made quite sure that the measuring instruments furnish correct results. This cannot be taken for granted. Not much imagination is required to picture to oneself the possible consequences which incorrect measuring instruments may have.

It is to be regretted that there are again and again cases where patients suffer severe damage due to incorrect measurements.

Despite the high standard of measuring techniques, it cannot be altogether excluded that incorrectly indicating measuring instruments are marketed or that measuring instruments, which originally furnished correct results, change their characteristics in the course of time and produce measurement results affected by inadmissibly large errors.

It is almost impossible for the users of such medical measuring instruments, namely the doctors and their staff, to detect these errors by themselves. They are not trained for this, and they do not have the necessary test equipment at their disposal. They are often even not aware of the fact that regular tests and calibrations are necessary and that you cannot blindly trust the indications of measuring instruments.

What can be done to guarantee the reliability of medical measuring instruments ?

---

(\*) This article was presented as an introduction to the Workshop on Medical Measuring Instruments organized by Germany in April 1991.

## 2. Legal regulations for medical measuring instruments

Health is something that should be protected. In the Federal Republic of Germany, practising of the medical profession is therefore regulated by laws and regulations.

Regulations for measuring instruments used in medicine or for the production and testing of medicaments are contained in the Metrology and Verification Act [1] and its implementing regulations [2, 3].

Table 1 shows which measuring instrument categories are covered.

TABLE 1 – MEDICAL MEASURING INSTRUMENTS COVERED BY THE METROLOGY AND VERIFICATION ACT OF 1985 OF THE FEDERAL REPUBLIC OF GERMANY

Clinical thermometers (mercury-in-glass, with maximum device)  
Clinical electrical thermometers  
Clinical radiation thermometers  
Thermography units  
Automatically-evaluating electrocardiographs  
Absorption photometers  
Medical syringes  
Non-invasive blood-pressure measuring instruments  
Blood sedimentation tubes  
Haemocytometer dilution pipettes  
Cell counting chambers  
Eye tonometers  
Ophtalmodynamometers  
Therapy level dosimeters with ionization chambers  
Pure tone and speech audiometers  
Pedal-operated ergometers  
Weighing instruments  
Instruments for determining the density of fluids  
Volume measuring instruments.

On the basis of the tests and verifications prescribed for these measuring instruments, information has been obtained about their metrological properties. Some results will be given to illustrate the situation.

The most common instruments to determine the human temperature are the mercury-in-glass thermometers. They have been manufactured for more than 100 years in the shape still known to us today, and large numbers of them are being used.

Fig. 1 shows the results of verifications carried out in the past five years.

Two things are striking: first, the large number of 3 to 5 million thermometers to be verified per year and, secondly, the almost constant percentage of rejections, amounting to about 3 %. The thermometers are rejected when the requirements of the Verification Ordinance are not complied with.

The most frequent error found is the exceeding of the maximum permissible errors. Even with this simple type of measuring instrument, whose design has not changed for decades, errors occur with frequencies in the per cent range.

Fig. 2 shows the results for sphygmomanometers. In this case, stronger differentiations must be made.

In contrast to glass thermometers where we may assume that their metrological properties will remain unchanged, time-dependent changes are to be expected in the case of sphygmomanometers as is the case with other measuring instruments. Sphygmomanometers are, therefore, not only subject to initial verification but also to periodic verification. The interval between periodic verifications is two years.

About 1 % of the instruments on an average is rejected upon initial verification, that is to say, they are not verified because they are not in compliance with the regulations. This percentage increases to 10 % on subsequent verification unless the instruments have been overhauled or repaired prior to this. Even 2 %, on an average, of the instruments repaired prior to subsequent verification cannot be verified.

The situation is similar with eye tonometers used to measure the intraocular pressure of the eye. The reject rate is below 1 % on initial verification, about 4 % on subsequent verification if the instruments have been overhauled or repaired, and it is about 16 % if no repairs have been made (Fig. 3).

The results obtained for other types of measuring instruments are published annually in the PTB-Mitteilungen [4].

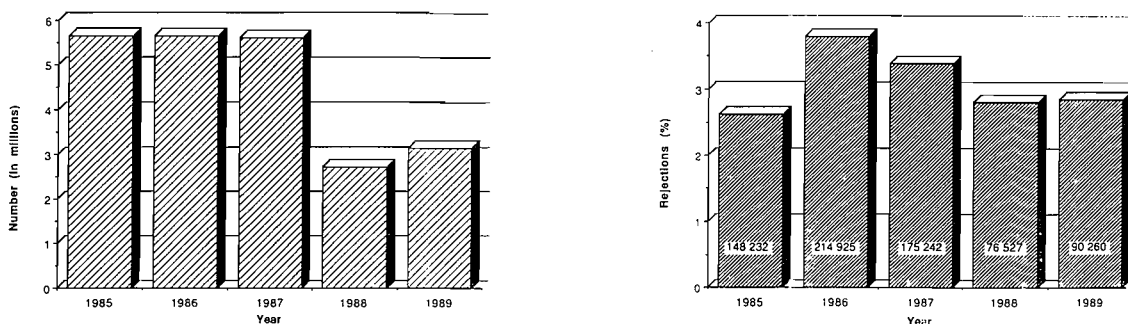

Fig. 1 – Results of initial verification of clinical mercury-in-glass thermometers

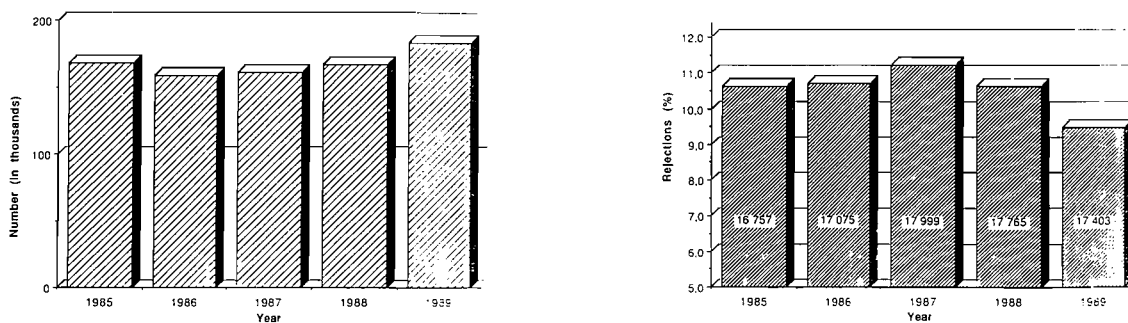

Fig. 2 – Results of reverification of sphygmomanometers without previous maintenance

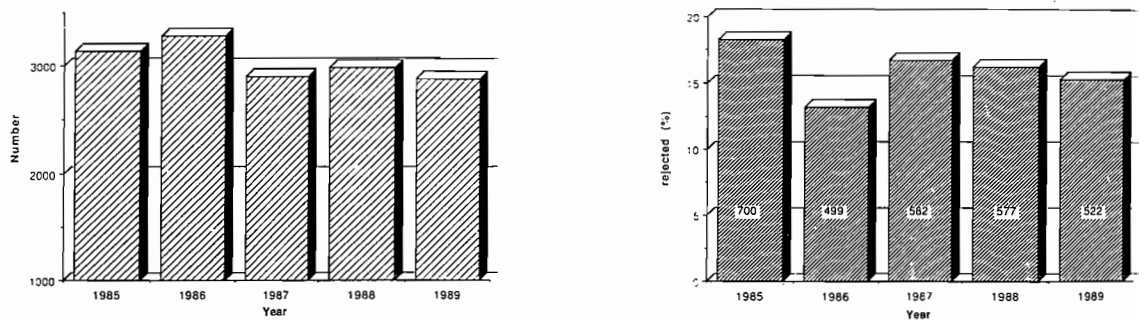

Fig. 3 – Results of reverification of eye tonometers without previous maintenance

### 3. Measures taken to ensure correct measurements

The objective to be attained by the legal measures taken can be described as follows:

Measuring instruments must be designed and constructed so that no faulty measurements are to be expected over a sufficiently long period of time when the instruments are properly used.

A glance at Table 1 shows that quite different categories of measuring instruments are concerned. The spectrum covers both simple volume measuring devices made of glass and complex therapy level doseimeters as well as automatically-evaluating electrocardiographs.

The measures prescribed to ensure correct measurement results differ in a similar way.

To give an example of simple volume measuring device made of glass, the regulations for haemocytometer dilution pipettes will be discussed in the following.

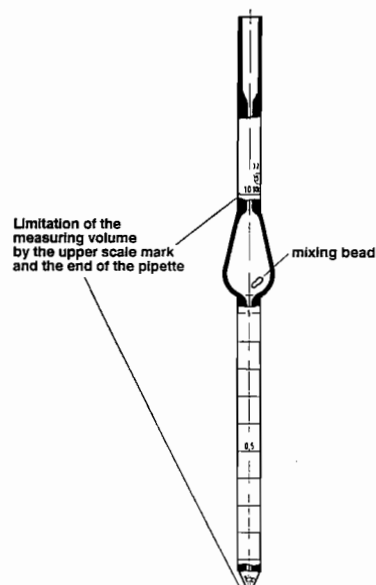

Fig. 4 – Haemocytometer dilution pipette

Haemocytometer dilution pipettes (Fig. 4) are used to dilute blood specimens to allow the proportion of red and white blood cells to be determined. The regulations of the Verification Ordinance for this measuring instrument category are given below.

## ANNEX 15 TO THE VERIFICATION ORDINANCE, SECTION 6

### Haemocytometer dilution pipettes

#### 1 Acceptance

Haemocytometer dilution pipettes will be accepted for national verification.

#### 2 Measuring instrument categories

Haemocytometer dilution pipettes can be designed for the counting of

- erythrocytes (dilution pipettes R) or
- leucocytes (dilution pipettes W).

#### 3 Adjustment and graduation

The haemocytometer dilution pipettes will be adjusted to water poured in and contain three volumes whose ratio

- a) for haemocytometer dilution pipettes R, is equal to that of 0.5 to 1 to 101,
  - b) for haemocytometer dilution pipettes W, is equal to that of 0.5 to 1 to 11
- and which are marked accordingly.

#### 4 Inscriptions

On the haemocytometer dilution pipettes, the name of the manufacturer or dealer or his firm's symbol must be indicated.

#### 5 Maximum permissible errors

The maximum permissible errors on verification for the ratio of the volumes to the reference volume marked by a 1 will be 3 % of this ratio.

In addition to the inscriptions, only the maximum permissible errors must be checked on verification. This is done by determining the volume using water.

Nothing else is required since measuring instruments made of glass meet the stability requirements. The material, glass, is dimensionally stable, meaning that the volume of a volume measuring device does not change during use, even over long periods of time. The material does not allow bending or denting, and wear does not occur. Subsequent verification is therefore not necessary.

Verification guarantees that only such measuring instruments are used, which comply with the error limits deemed permissible. When used properly, the verified measuring instrument will therefore measure correctly. The objective - ensuring of correct measurements - has thus been achieved.

When all metrological properties can be tested on verification as is the case with the haemocytometer dilution pipettes no pattern approval is required. Fulfilment of the legal requirements will be tested upon verification.

More time and effort are required for complex measuring instruments, as the stability must usually be tested in this case.

Stability is the ability of a measuring instrument to measure correctly over a sufficiently long period of time. The interval between two verifications which is normally two years is considered sufficiently long. The stability test depends on the design of the measuring instrument and on the components, which essentially determine the stability.

If the manometer of a blood pressure measuring instrument consists, for example, of an elastic sensing element, the elastic properties of the spring material - and consequently the metrological properties - may change in the course of time. To guarantee a sufficient quality of the spring material, a regulation provides that

the indication must not vary by more than 4 mmHg if the manometer was subjected to a sinusoidal alternating pressure load in 15 000 cycles between 20 mmHg and 220 mmHg at a frequency of 50 min<sup>-1</sup> to 60 min<sup>-1</sup>.

If this test is successful, it can be assumed that the spring material is suitable for the intended use.

This property cannot be tested during verification because this test would take too much time. However, this is not necessary since a characteristic feature of the spring material is tested. If it is guaranteed that all manometers of a pattern are made of the same material and have been submitted to the same ageing procedure by the manufacturer, testing of a small number of instruments will be sufficient during pattern approval (and perhaps during initial verification) and the result will be applicable to all instruments.

This example illustrates the difference between tests carried out for pattern approval and tests executed within the framework of verification:

On verification, the individual properties of each measuring instrument are tested, for example whether it has been adjusted so that the maximum permissible errors are not exceeded, and whether all necessary inscriptions have been provided.

Within the framework of pattern approval, the properties are checked, which are characteristic of all instruments of the pattern concerned. The tests cover the material properties of components, which decisively determine the instrument's stability, and the influence of parameters such as ambient temperature, air pressure, air humidity or electromagnetic fields.

These influence quantities will have the same effect in instruments of the same pattern. It is therefore sufficient to assess within the scope of a pattern approval test whether they lead to inadmissibly great errors.

In the case of complex measuring instruments, the combination of pattern approval tests and verification will ensure that the requirements defined by law are fulfilled.

According to the Verification Act, the Physikalisch-Technische Bundesanstalt (PTB) is the body responsible for pattern approvals in the Federal Republic.

The necessary tests are carried out in laboratories, which are equipped with large-scale measuring and testing facilities.

It is the aim of these tests to determine the metrological properties under the conditions prevailing at the place where the measuring instrument will be used in future. In most cases it is therefore not sufficient to carry out the test only in air-conditioned laboratories. Depending on the environmental conditions under which the instruments are intended to be used, or which may possibly prevail at the place of use, the influence of the ambient temperature must be checked within a suitable range. This range extends from 0 °C to 40 °C for instruments, which are also used in the open air, for example, weighing instruments, and it is from 15 °C to 30 °C for instruments exclusively used in rooms, for example, therapy doseimeters.

If, owing to the design, the instruments may be affected by electromagnetic interferences - which can be the case with electronic instruments - the electromagnetic susceptibility must also be tested. The limiting values of radiated interferences have been specified in international recommendations and documents [5]. Complex equipment is required for these tests.

If all tests are successful, pattern approval is documented by a pattern approval certificate. A copy of this certificate is sent to the verification authorities for information. In addition to a description of the measuring instrument pattern, these documents also specify details of their verification if this is considered necessary.

The charges for the pattern approval test must be paid by the applicant. The pattern approval of a clinical electrical thermometer or of a sphygmomanometer takes about 100 hours for which about 10 000 DM will have to be paid.

Pattern approval and verification are typical preventive measures to ensure the correctness of measuring instruments. Responsibility for correct measuring instruments can, however, also be laid upon the user or the manufacturer. In this case, the manufacturer himself must ensure - and confirm this officially - that his instruments are in compliance with legal regulations. This holds, for example, for blood sedimentation tubes.

If the instruments are more complex, the regulations may prescribe in addition a pattern approval. A test carried out by the manufacturer and a certificate issued by him may replace verification, and regular maintenance may be required instead of subsequent verification. Legal regulations in Germany include a great number of measures, which are taken to reach the protection goal in the most efficient way.

#### **4. The advisory board for medical metrology**

The Verification Act authorizes the Federal Minister of Economics to issue ordinances for the implementation of the Verification Act. If medical measuring instruments are concerned, the Minister will follow the recommendations of the advisory board concerned.

The advisory board for medical measuring instruments was set up in the early eighties when the Verification Act was amended. It comprises representatives of the users of medical measuring instruments, representatives of the manufacturers concerned, representatives from the world of science and one representative each from the Federal Board of Health, the federal states and the PTB. The PTB representative acts as chairman and calls a meeting of this board at least once a year.

It is the advisory board's task to give advice to the PTB and the Federal Minister of Economics with regard to the development of the verification system for the field of medical measuring instruments, and to propose regulations in compliance with the state of the art [6].

The PTB is an authority mainly concerned with questions of science and technology. It therefore lacks the experience of how medical measuring instruments are used in practice. The members of the advisory board have gathered the necessary experience and thus contribute decisively to the regulations being drawn up with due regard to practice. This would not be guaranteed without the board's assistance.

It is thus ensured that the measures taken to protect users and persons affected are discussed with representatives of all competent groups interested in this special field, and that the regulations published comprise appropriate requirements, which reflect the state of the art.

It will hardly be possible to specify reasonable error limits, boundary values for permissible environmental influences and effective test and maintenance procedures without close cooperation with the doctors and the manufacturers of medical measuring instruments.

In contrast to commercial transactions, where the verification system, on the basis of its supervisory power and controlling authority, ensures a reconciliation of the interests of the trade partners, the motivation of the verification sector to actively cooperate in the medical field is to support the doctors by testing the measuring instruments used by them. The metrological capabilities and facilities of the verification services, and their experience, are to be made use of also in this domain. Here the verification authorities do not play the role of arbiter or policeman, but that of a metrologically competent partner, who assists the doctors in their practical work by providing special services, i.e. the testing of measuring instruments. Members of the verification authorities' staff must explain this attitude to the doctors and their personnel to ensure constructive cooperation. However, they must also see to it that those who violate regulations are made to feel the full severity of the law.

## **5. International organizations of metrology and standardization**

International cooperation in the field of metrology is a must because the measures are not given by nature. Information across borders therefore presupposes international agreements.

As early as in 1875, an international organization of metrology was founded which is known by the name of Metre Convention.

Its organs are the highest international instances for the definition of the units in metrology and the metrological methods to be applied for their realization. Decisions are taken by the General Conference of Weights and Measures.

In the course of decades, the metric system was further developed to form the International System of Units (SI). The system has meanwhile become binding in more than 100 states.

The SI is also largely used in the field of medicine, an exception being the SI unit of pressure, the pascal. The blood pressure is however still often indicated in the unit mmHg, which does not fit in with the International System of Units, but the doctors do not want to change.

Metrological requirements for measuring instruments subject to legal control are laid down by the International Organisation of Legal Metrology, founded in 1955.

The International Recommendations and International Documents in the medical field which have so far been published by OIML, are listed in Table 2.



TABLE 2 - OIML RECOMMENDATIONS  
CONCERNING MEDICAL MEASURING INSTRUMENTS (1990)

R 07	Clinical thermometers (mercury-in-glass, with maximum device)	1978
R 16	Manometers for instruments for measuring blood pressure (sphygmomanometers)	1970
R 26	Medical syringes	1973
R 78	Westergren tubes for measurement of erythrocyte sedimentation rate	1989
R 89	Electroencephalographs - Metrological characteristics - Methods and equipment for verification	1990
R 90	Electrocardiographs - Metrological characteristics - Methods and equipment for verification	1990
R 93	Focimeters	1990
D 21	Secondary standard dosimetry laboratories for the calibration of dosimeters used in radiotherapy	1990

The task of drawing up international draft recommendations is entrusted to reporting secretariats. They are headed by representatives from such countries, which have already gained experience with the subject in question. Several reporting secretariats concerned with related subjects are grouped together in pilot secretariats.

The PTB has, for example, assumed responsibility for the pilot secretariat SP 26 "Measuring Instruments used in the Field of Health" which comprises the reporting secretariats listed in Table 3.

TABLE 3 - REPORTING SECRETARIATS OF OIML PILOT SECRETARIAT SP 26  
MEASURING INSTRUMENTS USED IN THE FIELD OF HEALTH

SP 26-SR 1	Instruments for counting of blood cells	Germany
SP 26-Sr 2	Pipettes for mixing blood	Germany
SP 26-Sr 3	Westergren pipettes for measuring blood sedimentation rate	Germany
SP 26-Sr 4	Bio-electrical measuring instruments	USSR
SP 26-Sr 5	Reference materials for medical instruments	USA
SP 26-Sr 6	Ergometers	Germany
SP 26-Sr 7	Measuring instrumentation for medical laboratories	Germany

In the course of the workshop, you will become acquainted with details of the international recommendations concerning clinical thermometers and sphygmomanometers.

The OIML member states are morally obliged to take over the metrological recommendations into national legislation.

The OIML closely cooperates with other standards organizations. The respective fields of work are clearly defined. For example, the OIML does not prepare special safety regulations for medical measuring instruments. Responsibility for this lies with the International Electrotechnical Commission (IEC) as far as electrically-operated instruments are concerned.

Compliance with safety regulations is checked by the bodies responsible for this, which, as a rule, do not belong to the legal metrology system. As in legal metrology, approvals by these bodies which cover safety aspects are required in many countries in order that the instruments may be used in the field of medicine.

The same applies to clinical tests, which are often required to prove that a new measuring method furnishes values comparable to those obtained by the methods used so far. In the case of sphygmomanometers, which determine the systolic and diastolic blood pressure electronically, proof must be established by clinical tests that the values obtained with these instruments correspond to those, which would be obtained with the aid of a stethoscope. If this was not the case, the decision on whether the blood pressure is too low or too high would possibly depend on the type of measuring instrument used and not on the patient's actual condition. This might have serious consequences for the patient examined. Before novel measuring principles are used, it must therefore be made quite sure that the results obtained are comparable to those found by conventional methods. Cooperation between doctors and metrologists on both national and international levels is necessary also for this reason.

## **6. Objectives of the workshop**

The results of tests and verifications of medical measuring instruments clearly show the importance of metrological controls. Although the extensive tests carried out within the framework of pattern approvals and verifications revealed many weak points of the measuring instruments concerned and induced the manufacturers to make improvements, the results obtained do not allow the prescribed controls to be dispensed with in the future.

The condition of medical measuring instruments in countries, which do not prescribe such controls, is most probably even worse. This is confirmed by information from countries, which have become aware of the problem and are looking for a solution.

This workshop will be suited to acquaint a relatively large number of participants with the International Recommendations for Clinical Thermometers and Sphygmomanometers, the test procedures, and to discuss the special problems which the individual countries are facing.

We have selected participants from such countries, which already have legal regulations for medical measuring instruments or are on the point of introducing such regulations. We therefore expect you to work actively, after having returned home, to implement the national regulations in your country and to start carrying out tests.

We have deliberately chosen Munich as venue for the workshop because it will be possible for you to see how large numbers of these instruments are verified in the Munich verification office and you will have the opportunity to carry out technical tests by yourselves on various instrument patterns. Good organization is a prerequisite for an economical verification of large numbers of measuring instruments and will therefore be an important task, which you will have to cope with in your country.

At the end of the workshop, we expect that you have gained the necessary knowledge and collected sufficient information to be able to carry out routine verifications of sphygmomanometers and clinical thermometers.

It will not be possible during the workshop to demonstrate tests and test methods for the pattern approval of medical measuring instruments. As a matter of fact, pattern approval tests must not be the first step to be taken, as another procedure can be recommended. In many industrialized countries, pattern approval tests are carried out by the national authorities, and instead of carrying out these comprehensive tests yourselves, it is recommended to ask the manufacturer or importer of the measuring instruments to furnish proof of the pattern approval.

In about a year's time, we will contact you, asking you to report on the progress achieved in your country in the testing of medical measuring instruments. You have the privilege to participate in this workshop, but you also assume the obligation to apply the knowledge acquired to the benefit of your country.

Only if new testing and verification activities for medical measuring instruments will start in your countries can the workshop be regarded as successful.

We hope that the workshop will meet your expectations, and we wish you every success in your practical work at home.

#### **References**

- [1] Metrology and Verification Act (Verification Act), as amended, of 22-2-85, Federal Law Gazette I, 1985, N° 11, pp. 410-422.
- [2] Verification Ordinance, General Regulations, Federal Law Gazette I, 1988, pp. 1659-1684.
- [3] Verification Ordinance, Medical Measuring Instruments, 1988, Physikalisch-Technische Bundesanstalt (editor).
- [4] Statistics of the verification authorities of all federal states, in PTB-Mitteilungen, vol. 100 (1990), pp. 424-425.
- [5] General requirements for electronic measuring instruments. International Organization of Legal Metrology, International Document N° 11, 1986.
- [6] The advisory board for medical metrology. PTB-Mitteilungen, vol. 97 (1987), pp. 42-43.

**ALLEMAGNE**

## **NON-INVASIVE BLOOD PRESSURE MEASUREMENT\***

by **Stephan MIEKE**

Physikalisch-Technische Bundesanstalt

*SUMMARY – This article describes in a didactic form the basic principles of operation and use of indirect blood pressure measuring instruments (sphygmomanometers) in their classical mechanical form and in their electronic version which applies the so-called oscillometric method.*

*SOMMAIRE – Cet article décrit sous une forme didactique les principes de fonctionnement et d'emploi des instruments de mesure indirects de la pression sanguine (sphygmomanomètres) dans leur version mécanique classique et dans la version électronique utilisant la méthode oscillométrique.*

### **Foreword**

As early as in 1733, Reverend Hales, an Englishman, carried out the first direct measurement of the blood pressure of a horse. About 160 years later, in 1895, Scipione Riva-Rocci, an Italian, developed the first practicable method for the non-invasive measurement of the blood pressure using a cuff applied to the upper part of the arm. Already nine years later, the Russian doctor Nikolai Sergejevitch Korotkoff presented the method named after him, where the sounds generated in the arteria brachialis are stethoscoped by the doctor. As early as in 1901, the German v. Recklinghausen recognized how important the correct cuff width is for the accuracy of this method. According to his findings, a width of 13 cm was fixed for the standard cuff.

Until the end of the seventies, non-invasive blood pressure measurements were carried out manually using a stethoscope. It was only at that time that the non-invasive blood pressure measurement was automated by means of electronic devices. First only the Korotkoff sounds were picked up by a microphone and indicated by a light-emitting diode (LED) and an acoustic signal provided in addition to the aneroid manometer. The users themselves had to read the pressure at the beginning and end of the sounds indicated by a visible and audible signal.

In the following years, the ease of operation was improved and the number of fields of application considerably increased. Instruments with digital indication, electromechanical pump, controlled pressure decay and additional printer output are today available in almost all market sectors.

Also at the end of the seventies, sphygmomanometers working by the oscillometric method were designed for the first time. These devices determine the systolic and diastolic blood pressure values with the aid of mathematical algorithms. Scientific investigations carried out in the sixties and seventies, and the availability of microprocessors made the development of this

---

(\*) This article formed part of the training material of the Workshop on Medical Measuring Instruments organized by Germany in April 1991.

method possible. Whereas in the beginning this method could only be offered for use in costly clinical equipment, it turned out by the end of the eighties that thanks to the further development of electronic components and the concurrent decline in price of these. Oscillometric instruments for use at home can now be offered at the lowest price level (below \$ 100).

Parallel to this technical development, since the end of the sixties, standards have been drawn up and requirements defined on national and international level. As early as in 1973, an OIML recommendation for non-automatic sphygmomanometers was drawn up, which is still valid today and which often forms the basis of national requirements.

## 1. The blood circulation

### 1.1 The heart as a pump

Man's biological functions are maintained by the circulation of the blood through the human body. This transport system performs many functions; for example, oxygen and nutrients are supplied to the cells and carbon dioxide and metabolic products carried away. The blood and its constituents have many other functions, e.g. the defence against exogenic substances penetrating the body.

The blood is constantly circulating through man's arterial and venous system. This flow of blood to all parts of the body is maintained by two pumps, the left side and the right side of the heart (Fig. 1).

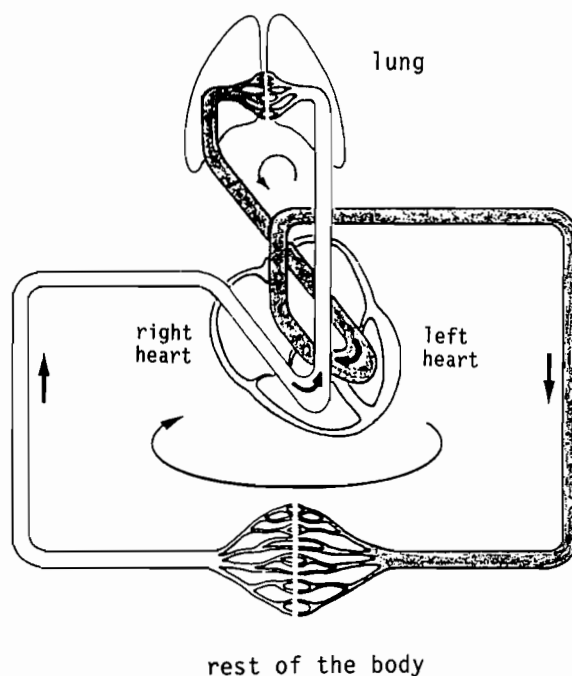

Fig. 1 – Circulation of blood in the human body, see text.

The left side of the heart pumps the blood oxygenated in the lungs into the arterial system, thus supplying blood to the muscles, organs and other cells. The blood passes from the lungs through the left auricle, the aorta and the arteries to ever smaller vessels which ultimately end at the cells in a large number of arterioles and capillaries.

In contrast to this, the right side of the heart pumps the blood, in which carbon dioxide has been absorbed, from the venous system into the lungs to make gaseous interchange possible. The blood in the numerous small veins takes up the metabolic products of the cells and carries these to the organs of excretion. Carbon dioxide is breathed out in the lungs. Through the venous system and the right side of the heart, the blood flows into the lungs.

The pumping of the left side of the heart leads to blood pressure fluctuations in the arterial system. The contraction of the cardiac muscle (systole) results in a strong expulsion of blood and a somewhat delayed pressure increase in the aorta. The pressure increase passes through a maximum while the expulsion of blood decreases again. During the relaxation phase of the heart muscle (diastole), the left heart valve closes. Although blood is no longer expelled, the blood pressure in the aorta does by no means drop to zero but continues to decrease slowly until it rises again as a result of the next systole. This effect is a consequence of the vessel's elasticity and peripheral resistance.

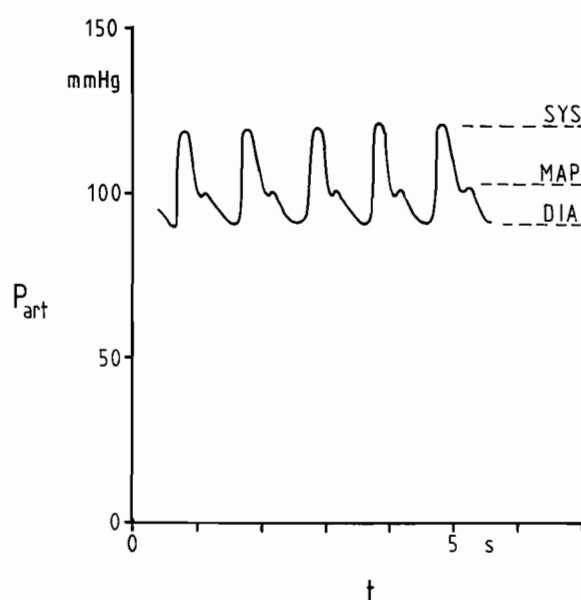

Fig. 2 – Arterial pressure curve

The maximum and minimum values of the pressure are referred to as systolic or diastolic blood pressure value, respectively, although, strictly speaking, the maximum systolic and the minimum diastolic blood pressure values are concerned (Fig. 2).

On the basis of these blood pressure values, a distinction is made between men with low, normal and high blood pressure (hypotonics, normotonics, hypertonics), cf. Table 1.

TABLE 1 - LIMITING VALUES OF THE BLOOD PRESSURE IN THE STATE OF REST

Hypotension:  $P_{\text{sys}} < 100$  mmHg,  $P_{\text{dia}} < 60$  mmHg

Hypertension:  $P_{\text{sys}} > 160$  mmHg,  $P_{\text{dia}} > 95$  mmHg

$P_{\text{sys}}$  = systolic blood pressure

$P_{\text{dia}}$  = diastolic blood pressure.

An additional value is often stated, i.e. the mean arterial pressure (MAP), which can be determined by various methods. The definition is given by the integral of the blood pressure curve related to one heart beat. Since the continual determination of the blood pressure curve is possible only by invasive methods and by only few non-invasive methods, different approximation methods exist.

The approximation most frequently applied is as follows:

$$P_{\text{MAP}} = P_{\text{dia}} + 1/3 (P_{\text{sys}} - P_{\text{dia}})$$

$P_{\text{MAP}}$  = mean arterial pressure.

Sphygmomanometers applying the oscillometric method usually indicate the oscillation maximum as mean arterial pressure, cf. point 2.2.

## 1.2 Places of blood pressure measurement

The upper part of the arm is normally used for non-invasive blood pressure measurement. There is only one larger artery in the upper arm, the arteria brachialis, which conveys blood to the lower arm and the hand.

The advantages of this place of measurement are as follows:

- the measurement is taken at not too great a distance from the heart,
- the influence of the periphery is not yet important,
- the measurement is taken at heart level (with the arm in normal position).

Another place of blood pressure measurement is the thigh. The disadvantages as compared with the upper arm are above all the greater distance from the heart and the necessity to take the measurement with the patient lying to avoid hydrostatic effects, i.e. to measure at heart level.

## 1.3 Causes and consequences of hypertension

An immediate cause of hypertension can be directly stated in a relatively small number of cases (5 to 10 %) only; this type is referred to as secondary hypertension. When the causes proper are successfully treated, the raised blood pressure can be normalized as well. Hypertension which is not the result of illness elsewhere is referred to as essential hypertension.

A frequent cause of secondary hypertension is a narrowed kidney artery. This narrowing results in an insufficient supply of blood to the kidneys which in turn causes the kidneys to produce an increased amount of renin. Renin is a substance which, through various intermediate stages, causes a rise in blood pressure in the entire circulatory system. The disturbance of the salt-water balance of the cells may be another cause of raised blood pressure. Too high sodium level leads to an increase in the peripheral resistance and thus to hypertension. The reason for this may be hypofunction of the kidneys or the secretion, due to tumors, of hormones which influence the salt-water balance.

As already mentioned, the immediate cause of essential hypertension cannot be clearly identified. Usually, raised blood pressure is, however, accompanied by an increase in the peripheral resistance and/or an increase in the heart's volume, i.e. an increased blood flow.

The most important diseases connected with hypertension are the following:

- arteriosclerosis
- stroke

- coronary diseases of the heart
- heart failure
- renal failure.

Diseases of the heart and the circulatory system are by far the most frequent causes of death in the Federal Republic of Germany (approx. 50 %). The number of persons suffering from hypertension is estimated at 20 % of the adult population, i.e. 10 million persons.

## 2. Methods

### 2.1 The Korotkoff method

The non-invasive method developed in 1905 by Nikolai Sergejevitch Korotkoff, a Russian doctor, uses a cuff and a stethoscope. The measurement is usually carried out on the upper arm, but measurement on the thigh is also feasible.

First the cuff on the upper arm is inflated to a pressure value higher than the expected systolic blood pressure, so that the blood stops flowing through the arteries beyond the cuff. The stethoscope is placed below the cuff, above the arteria brachialis. Air from the cuff is then slowly released by opening of the valve so that the cuff pressure drops slowly. While the pressure in the cuff is reduced, sounds can be heard with the stethoscope. The sounds named after Korotkoff follow the rhythm of the heart beats. When the Korotkoff sounds are heard for the first time, the manometer is read and the value taken as systolic blood pressure value. With the cuff pressure falling, the sounds change in tone colour and ultimately fade out completely; at this moment the doctor reads the cuff pressure once again and takes it as diastolic blood pressure value (Fig. 3).

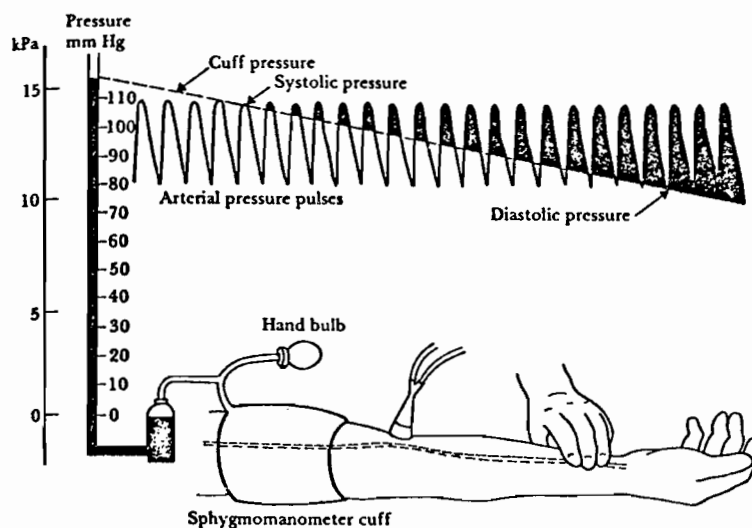

Fig. 3 - Non-invasive blood pressure measuring technique after Korotkoff

Today's state of the art allows this measurement to be automated; the Korotkoff sounds are picked up by the microphone and assigned to the respective cuff pressure value. The blood pressure values are digitally displayed by the instrument.

The sounds differ in amplitude and tone colour. A distinction can be made between five phases (Table 2).



TABLE 2 - CLASSIFICATION OF THE KOROTKOFF SOUNDS INTO PHASES

Phase I: The period marked by the first appearance of faint, clear tapping sounds which gradually increase in intensity.

Phase II: The period during which a murmur or swishing quality is heard.

Phase III: The period during which sounds are crisper and increase in intensity.

Phase IV: The period marked by the distinct, abrupt muffling of sound so that a soft, blowing quality is heard.

Phase V: The point at which sounds disappear.

The deflation rate is one of the most important factors for the accuracy of the Korotkoff method. Fig. 4 and Fig. 5 show measurements at different deflation rates for a patient having constant systolic and diastolic blood pressure and a constant heart rate.

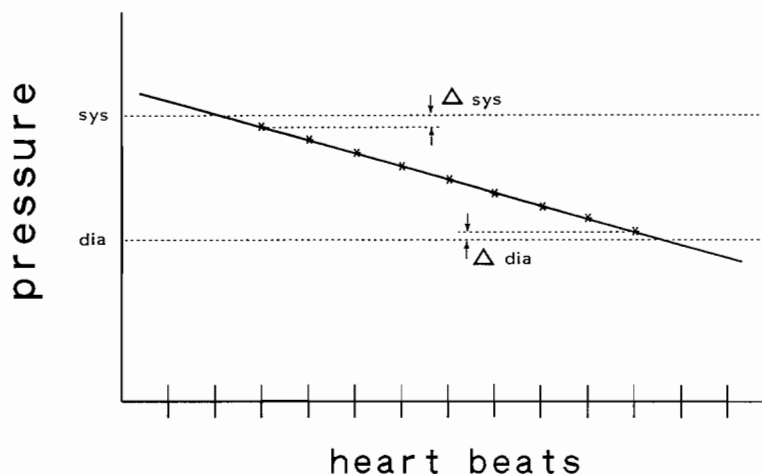

Fig. 4 - Measurement with normal deflation rate, 9 Korotkoff sounds are audible. The systematic errors  $\Delta_{sys}$  and  $\Delta_{dia}$  are indicated.

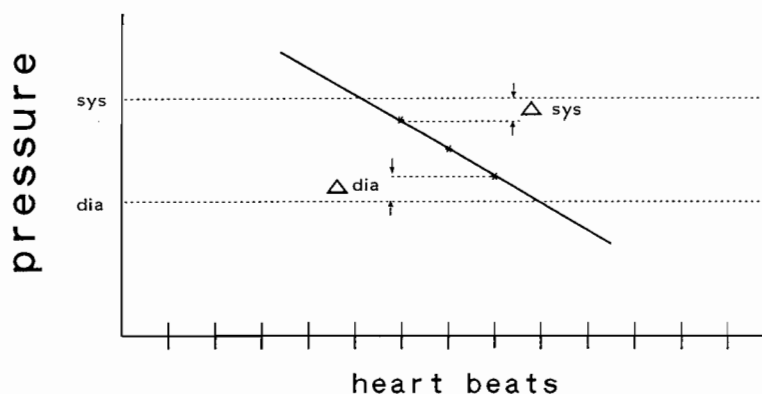

Fig. 5 - Measurement with high deflation rate, 3 Korotkoff sounds are audible. The systematic errors  $\Delta_{sys}$  and  $\Delta_{dia}$  are indicated.

In the case of normal deflation rate (Fig. 4) 9 Korotkoff sounds are detected, the errors of the non-invasive measurement  $\Delta_{\text{sys}}$  and  $\Delta_{\text{dia}}$  and the true systolic and diastolic blood pressure values are indicated. In the case of high deflation rate (Fig. 5) only 3 Korotkoff sounds are detected, the measurement errors are indicated as in Fig. 4.

The maximum errors for  $\Delta_{\text{sys}}$  and  $\Delta_{\text{dia}}$  are directly proportional to the deflation rate. As a consequence one would suggest very low deflation rates, minimizing this error, unfortunately it yields another problem. Low deflation rates ( $< 2$  mmHg/s) result in a long lasting measurement and an increase of blood in the lower arm. The blood is "trapped" in the lower arm because the venous pressure is too low ( $< 30$  mmHg) to pass the cuff and to flow back to the right heart. Since this is an extraordinary physiological state the "true" blood pressure in the arm is increasing, i.e. the blood pressure becomes different from the real one. As a compromise deflation rates of 2-3 mmHg/s are suggested to get the best results.

## 2.2 The oscillometric method

At the end of the seventies, automated sphygmomanometers applying the oscillometric method were developed for the first time. They were able to determine the systolic and diastolic blood pressure values by means of mathematical algorithms.

Similar to the Korotkoff method, the oscillometric method makes use of a cuff applied to the upper arm, however, no stethoscope is required. The oscillometric method can only be applied in electronic sphygmomanometers; manual measurement by the doctor with the aid of a manometer is not practicable.

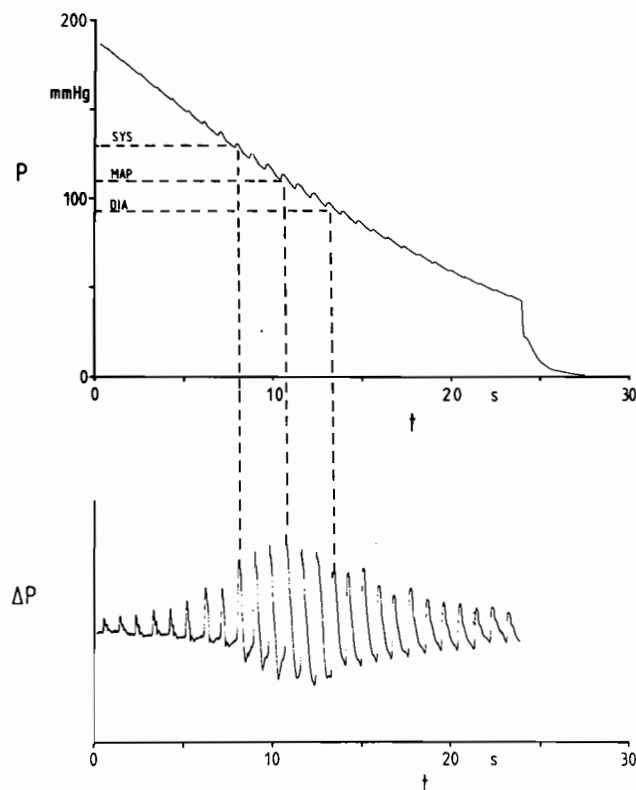

Fig. 6 - Upper part: curve of deflating cuff pressure.  
Lower part: amplitude of pressure oscillations.

The measurement procedure is as follows:

- First the cuff pressure is pumped to a value higher than the expected systolic blood pressure.
- Then the cuff pressure is deflated continuously or in steps.
- The pressure pulse in the arteria brachialis is transferred via the bladder of the cuff to the pneumatic system of the instrument and results in small pressure fluctuations (oscillations). Small fluctuations of the cuff pressure can already be observed before the systolic blood pressure value is reached. These pressure fluctuations are the important measured values of the oscillometric method as their amplitude changes while the cuff pressure is reduced further.
- The paired values of the oscillation amplitudes and the corresponding cuff pressures are recorded during the measurement. These data are mathematically evaluated after the end of the measurement and the results, i.e. the blood pressure values, are displayed.

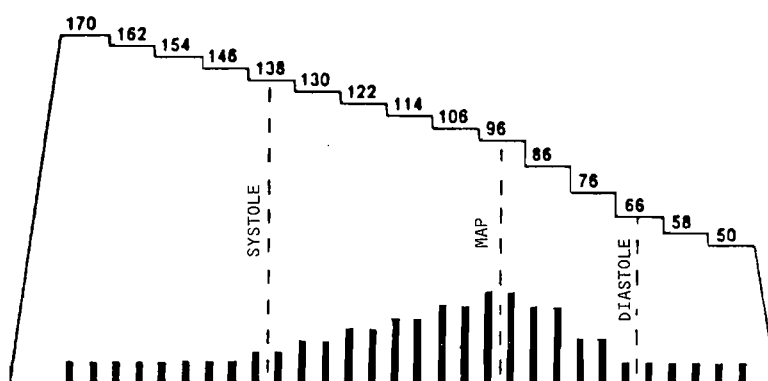

Fig. 7 - Stored oscillations, cuff pressure deflation in steps (the numbers indicate the pressure values in mmHg)

The mathematical procedures (algorithms) applied to determine the blood pressure values are often considered trade secrets. With the exception of some details, the algorithm most frequently used is, however, generally known and will be discussed in the following:

After the cuff pressure was deflated (in the example in Fig. 7, this deflation takes place in steps) from a value above the systolic blood pressure to a value below the diastolic blood pressure (170 mmHg and 50 mmHg, respectively, in Fig. 7), the values of the oscillation amplitudes and of the respective cuff pressures are stored in the memory. Fig. 7 shows the pressure amplitudes in the form of vertical black bars; the cuff pressure is indicated at each step of the pressure curve. Due to a special, patented procedure for the detection of artefacts, in the example given in Fig. 6 two oscillations of equal amplitude are recorded in every pressure step; basically, the storage of one oscillation amplitude is sufficient to calculate the blood pressure values.

On the basis of extensive investigations, the following relations have been discovered:

1. The maximum of the oscillation amplitude  $A_{\max}$  coincides with the mean arterial blood pressure, in short MAP, i.e. 96 mmHg in Fig. 7,
2. The systolic blood pressure is determined at about  $0.5 A_{\max}$ , i.e. at 138 mmHg in Fig. 7,
3. The diastolic blood pressure is determined at about  $0.75 A_{\max}$ , i.e. at 66 mmHg in Fig. 7,

Note: As to the factors of 0.5 and 0.75, the drawing in Fig. 7 does not fully correspond to the procedure described.

Only the principle underlying the procedure most frequently applied has been described here; to improve its reliability, the method has been refined and extended in many aspects.

### 2.3 Selection of deflation valve and cuff

The choice of the valve is important for the accuracy of the measurement.

Korotkoff method: The deflation rate must be adjustable to rates between 2 and 3 mmHg/s as explained in chapter 2.1.

Oscillometric method: Instruments with simple algorithms for the determination of blood pressure values require constant deflation rates, which have to stay within the limits of 2 to 3 mmHg/s during the deflation period.

Figure 8 shows the deflation curve of a cuff at a human arm in combination with a standard valve (S) and a linearizing valve (L). The pressure decay of the standard valve follows an e-function, i.e. (too) high deflation rates at high cuff pressures and (too) low deflation rates at low cuff pressures. The pressure decay of the mechanically linearizing valve is almost constant over a wide pressure range. Linearizing valves are in general favorable for accurate measurements. An exception might be high-tech clinical monitors, which are able to compensate non-linear deflation curves by highly sophisticated algorithms.

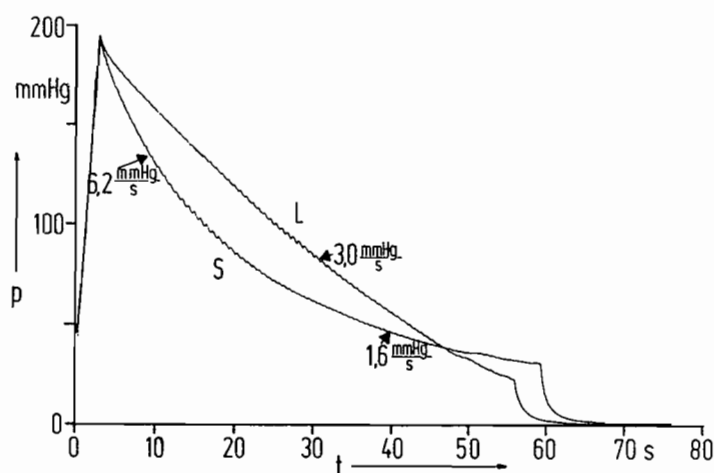

Fig. 8 - Pressure deflation rate for a standard valve (S) and a linearizing valve (L)

Most non-invasive methods use the cuff designed by Riva-Rocci. The cuff consists of a fabric or synthetic sleeve enclosing a bladder. Disposable cuffs, especially those for newborn children (neonates) are often manufactured of welded synthetic material with integrated bladder.

Since the cuff pressure directly influences the blood flow through the arteria brachialis - tissue, muscles and bones may be considered as almost incompressible - the ratio of upper arm circumference to cuff width is of decisive importance to the accuracy. National organizations, mostly medical associations, have drawn up recommendations for suitable cuffs. The German recommendations are summarized in Table 3. Table 4 shows the American recommendations.

TABLE 3 - CUFF BLADDERS RECOMMENDED IN GERMANY (MINIMUM BLADDER SIZES)

patient	upper arm circumference (cm)	bladder of the cuff	
		width (cm)	length (cm)
infant		5	8
child		8	13
adult	< 33	12 - 13	24
	33 - 41	15	30
	> 41	18	36

TABLE 4 - CUFF BLADDERS RECOMMENDED BY THE AMERICAN HEART ASSOCIATION

patient	upper arm circumference (cm)	bladder of the cuff, width × length (cm × cm)
neonates	5 - 7,5	3 × 5
infant	7,5 - 13	5 × 8
child	13 - 20	8 × 13
small adult	17 - 26	11 × 17
adult	24 - 32	13 × 24
large adult	32 - 42	17 × 32
thigh	42 - 50	20 × 42

### 3. Fields of application

#### 3.1 Use at home

Until 1988, only sphygmomanometers applying the Korotkoff method were approved for use at home in the Federal Republic of Germany. Only since this time have instruments working according to the oscillometric method become sufficiently reliable for this field of application, and as a result the PTB has approved patterns of such instruments for verification. In the beginning, imperfections inherent in some of the algorithms applied to determine the systolic and diastolic blood pressure values were tolerated because it had been assumed that the considerably easier placing of the transducer (bladder) will at least compensate these drawbacks in practical application.

Upon pattern approval, special attention is focussed on well-adjustable, linearizing pressure release valves, since the accuracy of the instrument depends directly on the deflation rate.

The percentage of instruments applying the oscillometric method is steadily increasing; in the USA and Japan it exceeds 90 %.

### **3.2 Use in the doctor's practice**

Practitioners generally use aneroid or mercury manometers and the stethoscope for blood pressure measurements. Automated sphygmomanometers are used to a lesser extent.

### **3.3 Use in clinics**

As to instruments for use in clinics, the manufacturers expect high sale rates for non-invasive sphygmomanometers at present and in the future. This has led to a considerable increase in the number of instruments of this type offered on the market.

The non-invasive measurement by means of modern automated sphygmomanometers is to replace part of the invasive measurements and set the doctors and the nursing staff free from routine measurements. In addition, manufacturers which have so far been active only in certain branches of medical engineering, have now started to offer instruments of their own or devices manufactured under licence, which the customer expects as part of a package. Practically all instruments in this field of application use the oscillometric method. They are equipped with electro-mechanical pumps or compressed-air reservoirs for the inflation of the cuff; the cuff pressure deflation - either continuously or in steps - is controlled; if necessary, the devices adapt themselves to the actual blood pressure by repumping, repeat the measurements at regular intervals and raise alarm when freely selectable limits are exceeded. Often they are connected to central computers via interfaces and can print out the values if desired.

The usually most intelligent algorithms for the determination of the blood pressure values and comprehensive programs for artefact detection allow the pressure to be deflated at rates higher than those recommended by the physicians (2-3 mmHg/s) without reducing the accuracy.

During their rounds in the hospitals, doctors normally use aneroid and mercury manometers and a stethoscope.

The measurement of the blood pressure of newborn children poses a serious problem in practice. Invasive measurements are at present the most reliable ones, however, because of the risks involved, they are often carried out only in critical cases. Auscultation of the Korotkoff sounds is often impossible; the systolic blood pressure value at best can be determined.

Here the oscillometric method is an alternative. There are special instruments which take the exceptional features, e.g. particularly small cuffs, into account.

### **Literature**

- Blood pressure measurements;  
Ed. by W. Meyer-Sabellek, M. Anlauf, R. Gotzen, L. Steinfeld; Steinkopff-Verlag/Springer-Verlag, 1989
- Monitoring in Anesthesia and Critical Care Medicine;  
Ed. by C.D. Blitt; Churchill Livingstone, 1985
- Monitoring Practice in Clinical Anesthesia;  
J.S. Gravenstein, D.A. Paulus; Harper & Row Publishers, 1982

- Arterial hypertension, Report of a WHO Expert Committee;  
World Health Organisation Technical Report Series 628, 1978
- OIML International Recommendation N° 16: Manometers for instruments for measuring blood pressure (1973)
- Revision of the OIML Recommendation: Instruments for measuring blood pressure (sphygmomanometers), Third Draft, 1990
- German Verification Ordinance (Weights and Measures Regulations),  
Appendix 15, section 4 "Non-invasive blood pressure measuring equipment", August, 1988
- Requirements and Test Regulations of the Physikalisch-Technische Bundesanstalt for non-invasive blood pressure measuring equipment, PTB-A 15.4, April 1988
- Guideline for clinical tests for automated sphygmomanometers;  
valid for instruments with continuous pressure decay (rate  $\leq 3$  mmHg/s), PTB, 4 March 1991
- Recommendations for Human Blood Pressure Determination by Sphygmomanometers, AHA Committee Report, 1980.

## THEORY AND SIMULATION OF OSCILLOMETRIC BLOOD PRESSURE MEASUREMENTS

by Heinz TÖMBÖL

Bundesamt für Eich- und Vermessungswesen

*SUMMARY – This article attempts to explain the principle of non-invasive oscillometric measurement of blood pressure which is now currently applied in new designs of electronic sphygmomanometers.*

*The pattern approval and verification of such instruments are greatly facilitated by use of a pressure simulation installation developed by the author which reproduces the oscillations actually occurring during blood pressure measurements using the cuff method.*

*The article is illustrated by the practical results obtained in comparing oscillometric sphygmomanometers with the classical method of Riva-Rocci/Korotkoff and with the new simulation method.*

### 1. The classical method according to Riva-Rocci/Korotkoff

The classical method for non-invasive blood pressure measurement applied by physicians is the method according to Riva-Rocci and Korotkoff. Using his experience in blood pressure measurement the physician can by this method make diagnoses of cardio-vascular diseases to choose the corresponding method of treatment, for example the prescription of hypotensive remedies if hypertension. That is the reason why any new method of blood pressure measurement must be positively traceable to the conventional method. Before discussing the oscillometric method in detail we will have a look at the diagram of the pressure inside the brachial artery.

### 2. Conceptions

To maintain the circulation, blood circulates through the vessels with a certain admitted (quasi-) static pressure superimposed by the pressure impulse of the blood being pulsatingly transported by the heart. The contracting cardiac muscle generates these pressure waves having the highest pressure obtainable at maximum contraction. This maximum pressure  $p_s$  is called systolic pressure. Figure 1 shows one period of the arterial pressure curve measured "in vivo", i.e. in the open blood circulation by using a cannula and a pressure sensor. In this graph, the steep leading edge and the fast reaching of the systolic pressure are to be noticed. At the distraction of the cardiac muscle the blood pressure drops slowly to a low value. The lowest pressure  $p_D$  reached before the cardiac muscle's recontraction is called diastolic pressure.



The only method to determine exactly the Mean Arterial Pressure (MAP) is the invasive method. In the pressure curve of the arterial pressure a line divides the area so that the sum of the positive areas is equal to the sum of the negative areas ( $A_1 = A_2 + A_3$ ).

This pressure value  $p_M$  is the MAP.

The MAP cannot be determined directly by the Riva-Rocci/Korotkoff method. Nevertheless, there exists an equation for approximation of the MAP by using the values of the systolic and diastolic pressures.

Example with the denominations of Figure 1:

$$p_M = p_D + \frac{1}{3} (p_S - p_D) \quad (1)$$

Example:  $p_S = 16.5$  kPa (124 mmHg),  $p_D = 10.3$  kPa (77 mmHg),  
 $p_M = 12.4$  kPa (93 mmHg).

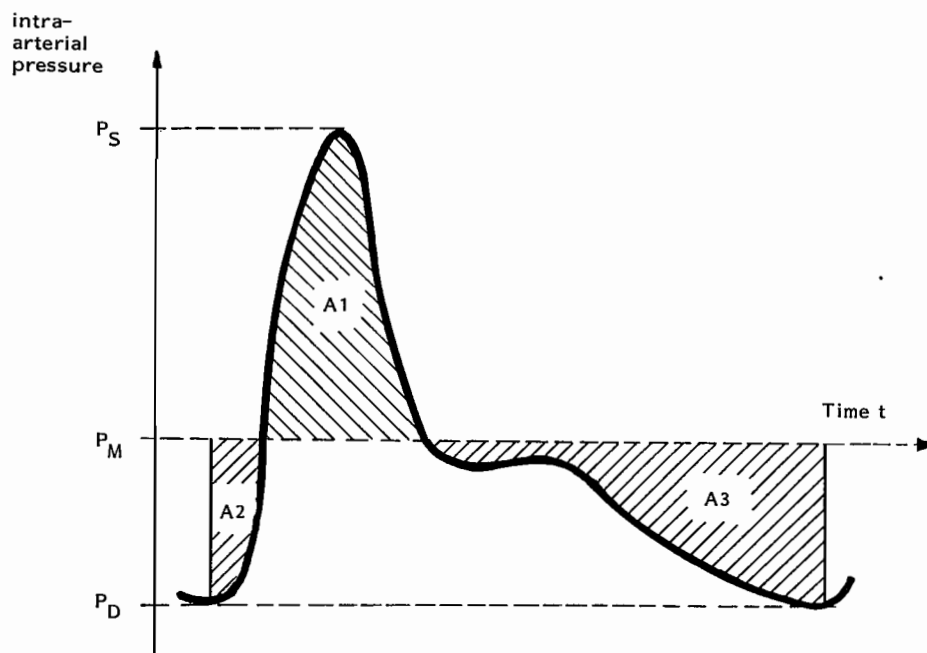

Fig. 1 - Blood pressure in the brachial artery (1 period)

The absolute quantities  $p_S$  and  $p_D$ , the ratio  $p_S/p_D$  and the MAP also are measuring values that inform about the constitution of the heart, the circulation and arterial diseases.

Since the invasive measurement is unreasonable for the patient, indirect methods of measurement had to be developed.

### 3. Oscillometric blood pressure measurement

Riva-Rocci's indirect method of measurement is also used for the oscillometric method. For this purpose a cuff is put on the limb and inflated with pressure. The pressure is controlled by the aid of a verified manometer.

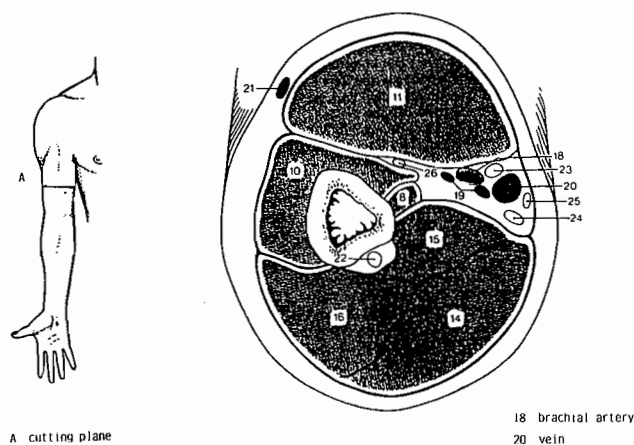

Fig. 2 - Cutaway view of the upper arm (A)

Figure 2 shows the cross section of the upper arm. The brachial artery is the only artery passed through by the blood pressure waves coming from the heart. The other veins - being blood vessels for the blood flowing back to the heart with low pressure - do not contribute to the indirect blood pressure measurement. For further considerations only the brachial artery is important.

### 3.1 Principle and comparison with the classical method

For the illustration of the process of blood pressure measurement let us have another look at our example. We assume a systolic pressure of 16.5 kPa (124 mmHg) and a diastolic pressure of 10.3 kPa (77 mmHg). The cuff is inflated with a pressure of 4 kPa (30 mmHg) above the probable value of the systolic pressure, that is 20.5 kPa (154 mmHg). Thus the muscular tissue ties up the elastic brachial artery.

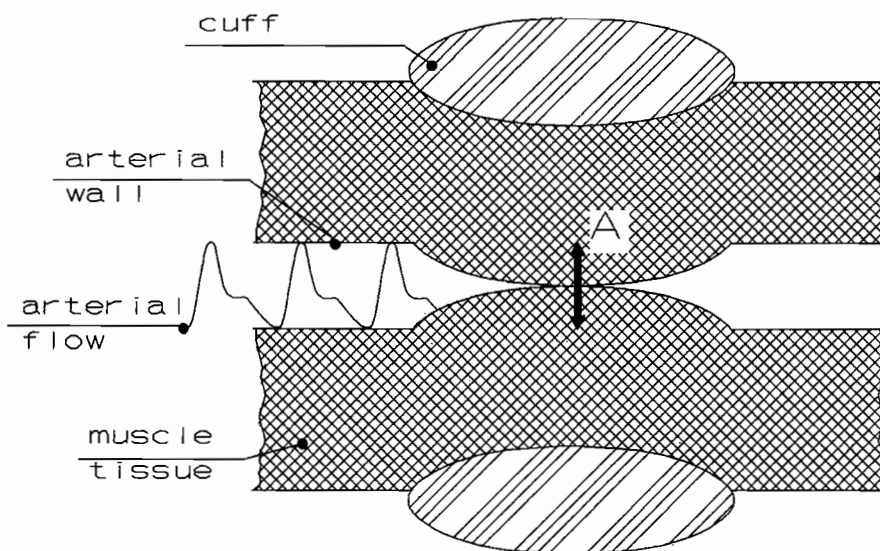

Fig. 3 - Cutaway view of the tied up brachial artery

The pulse waves running against the occlusion (fig. 3, place A) with a maximum pressure of 16,5 kPa (124 mmHg) are unable to open the artery and are reflected as long as the cuff pressure exceeds the pressure in the artery. These pulse waves produce small variations in pressure  $\Delta p$ , since artery and muscle tissue are not rigid bodies, and part of the waves' energy is transferred to the elastic system. The cuff has an air-bladder onto which these elastic processes are directly transferred, nearly free from losses. This means that every movement of the brachial artery is transferred to the cuff and to the pneumatic system of the sphygmomanometer and, being a pressure oscillation, it is superimposed to the quasi-static pressure in the cuff.

In our example the pulsating waves produce a variation of pressure  $\Delta p$  at the frequency of the heart. This variation of pressure is superimposed to the static pressure of 20.5 kPa (154 mmHg). This variation of pressure is already measurable and amounts up to 0.15 kPa (1 mmHg).

In the further course of the blood pressure measurement the static pressure in the cuff is slowly deflated (deflation rate of 0.3 to 0.5 kPa/s or about 2 to 4 mmHg/s). As long as the pressure in the cuff exceeds the systolic pressure, the amplitude of the oscillations will only rise a little.

As soon as the intra-arterial pressure rises to an amount that momentarily exceeds the cuff pressure, the pulse waves, running against the occlusion, start to open the brachial artery and the blood can flow through the artery (first opening) within the short duration in which the pulse pressure is higher than the cuff pressure (see fig. 4, hatched area). This will only partially be successful, if the value of the cuff pressure is about the value of the systolic pressure i.e., the blood has to flow through a narrowed and constricted artery. In this constriction the flow rates are rising, the arterial walls start to vibrate and produce sound effects. These sound effects can be auscultated with a stethoscope in the arm's bend (discovered by the Russian physician Korotkoff).

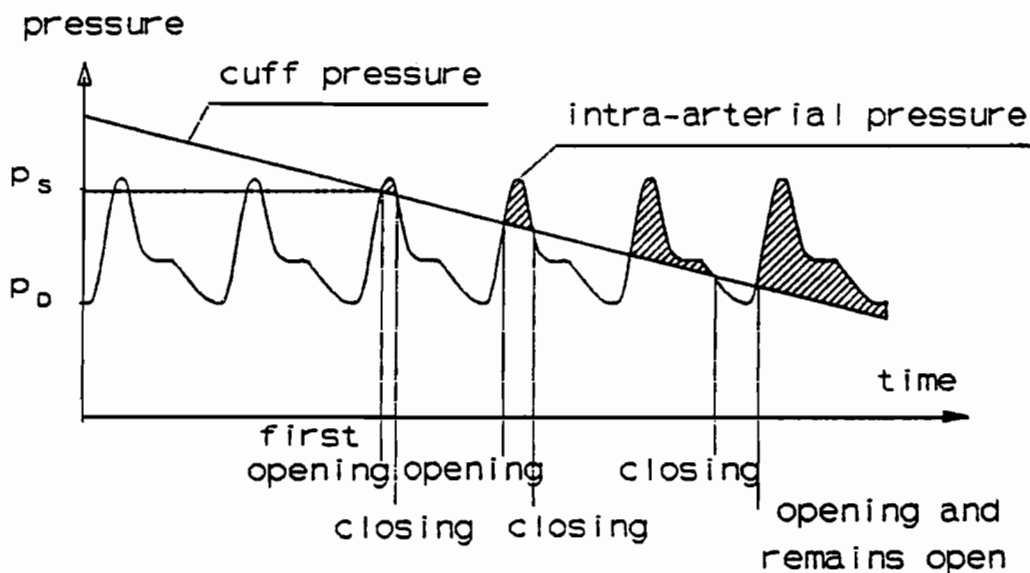

Fig. 4 - Duration of the effect of the intra-arterial pulse waves in the cuff during blood pressure measurement

A physician using the classical method determines the pressure in the cuff with a verified manometer when the Korotkoff-sound appears first to find out the systolic pressure  $p_S$ .

Studying the variation in pressure  $\Delta p$  in the cuff (fig. 5 shows the pressure curve in the cuff during a blood pressure measurement), one can notice that at the moment the brachial artery opens first, the variations in pressure  $\Delta p$  are rising (longer intervals between opening and closing).

At further reduction of the cuff pressure, these oscillations become higher since the artery's contraction is being stronger by the pulse waves running against the occlusion. At a certain pressure called MAP, the artery is widened to the full diameter at every beat.

That is the moment when the oscillations reach their maximum. In our example this pressure is 12.4 kPa (93 mmHg).

At further deflation of the cuff pressure the artery is no longer entirely closed by the cuff, a small cross section remains and the oscillations become smaller.

When the cuff pressure drops to a value below the diastolic pressure, the artery cannot be deformed any more since the pressure in the brachial artery is higher than the cuff pressure at any time (the artery opens and remains open).

The oscillations become small again, but do not stop completely, since, affected by the elasticity of artery and muscle tissue, the arterial cross section is slightly widened with every beat.

Carrying out the Riva-Rocci/Korotkoff method, one will notice that the Korotkoff-sound is clearly getting lower. The pressure value of the cuff is attributed to the diastolic pressure.

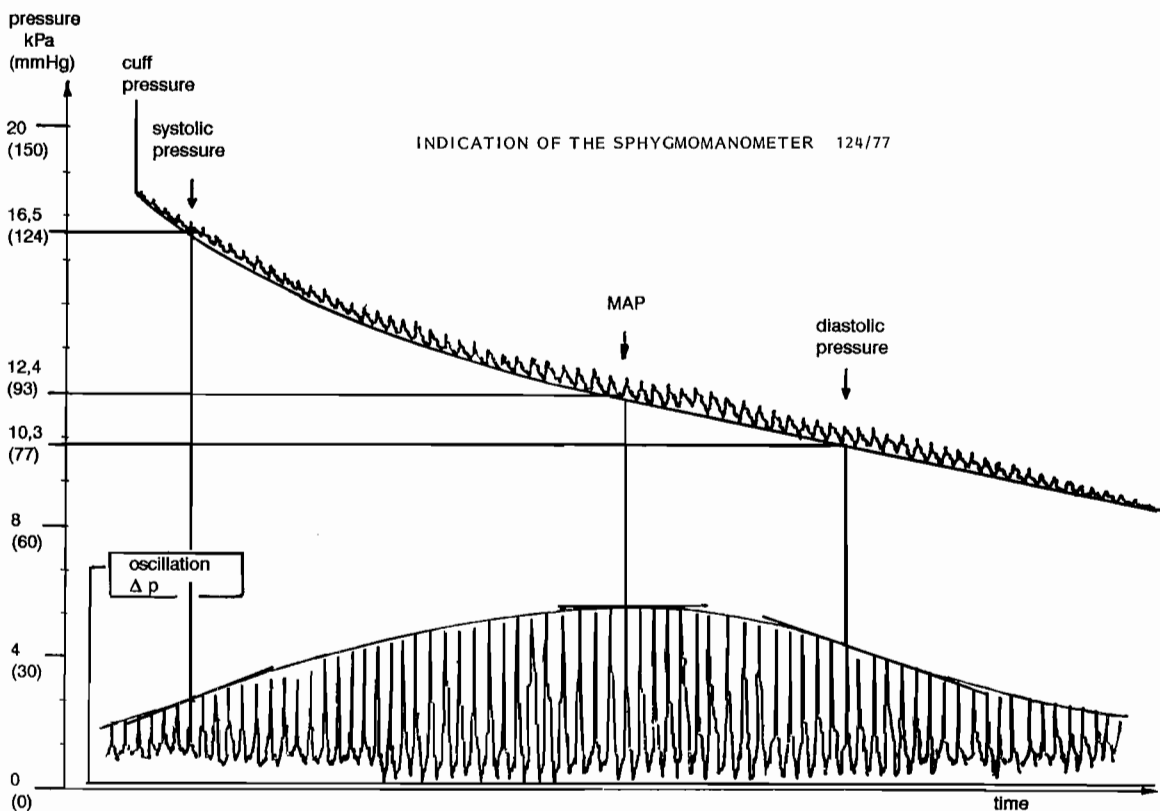

Fig. 5 - Cuff pressure - oscillation during a blood pressure measurement

### **3.2 Evaluation method for the oscillometric blood pressure measurement**

By way of experiments on hundreds of test persons it was found out that the systolic pressure is the one at which the oscillations in the cuff are rising suddenly (first stationary tangent), the diastolic pressure is the one at which the oscillations in the cuff are falling suddenly (second stationary tangent).

This confirms the theory that owing to the sudden opening of the brachial artery at systolic pressure, the amplitude of the oscillations in the cuff will rise (first turning point) and that the amplitude of the oscillations will fall at diastolic pressure (second turning point because the full cross section of the artery has been reached).

Moreover it was found out that the Mean Arterial Pressure MAP is measured when the oscillations are at their maximum.

## **4. Simulation of oscillations in the cuff and clear attribution to the pressure values defined for systolic and diastolic pressures**

### **4.1 Artificial arm**

Since the manufacturers of oscillometric sphygmomanometers have calculated the attribution of the blood pressure values with statistical methods, the determination of the systolic and diastolic pressures will mostly be correct. But how about the individual case?

To make statements on the individual measurement, it is necessary to simulate blood pressure values and, if possible, for any pair of values (diastolic and systolic pressures) and for different pulse frequencies.

The best simulation is the one with the "artificial arm" that simulates the circulation with an artificial heart and with an artificially built human upper arm. The cutaway view of the upper arm (fig. 2) shows the complicated structure only schematically, in reality these conditions are much more complex. It is even more complicated to simulate the process inside the heart.

However, it will be possible to develop a simplified system, without the necessity to copy the complex construction of the circulation, if this simplified system adheres to the fundamental conditions.

For the simulation for oscillometric blood measuring instruments it would be sufficient to feed the cuff with the oscillations of pressure that are superimposed to the cuff pressure (with their characteristic envelope curve). Thus, what matters is not the exact simulation of the curve in the brachial artery but the simulation of what is generated in the cuff by the muscle tissue. Figure 4 shows that during a blood pressure measurement mostly the peaks of the pulse waves open the artery and that the oscillations generated in the cuff have this pulse form. Only near the diastolic pressure a flattening of the trailing edge occurs that is of no importance for the evaluation.

To receive oscillations with their characteristic envelope curve - as they occur in practice - it is necessary to simulate the opening and closing of the artery. It would not be sufficient for the simulation simply to store the oscillations of a real blood pressure measurement in a microprocessor and to feed the cuff by a voltage/pressure transformer, because only a single curve with exactly one pair of values for diastolic and systolic pressure would be generated and, what is even more important, the statement that the values for systolic and diastolic pressure correspond to the turning point of an envelope curve could not be verified.

## 4.2 Simulation installation

An operative simulation set-up

- has to generate primary pulses, whose course corresponds to the peak of the blood pressure curve in the brachial artery (please note the steep leading edge and the ratio of pulse length and pulse pause).
- needs a "simulation chamber" or "tubular chamber" where the primary pulses act on an elastic tube system that can be tied up with the cuff (please note that the elasticity should resemble to the elasticity in the brachial artery).
- needs a coupling of the primary pulses with the elastic tube system and the cuff to produce oscillations.

The oscillations produced by the elastic tube system must be coupled with the pneumatic system of cuff and sphygmomanometer.

Please note the height of the oscillations, the course of the envelope curve and the pre- and postoscillations.

### 4.2.1 Primary pulses

The primary pulses are produced pneumatically. By the means of two special pressure regulating valves, any stable pressure between 10 mmHg and 300 mmHg, for the systolic and for the diastolic pressure as well, can be separately adjusted. With an electronically controlled 3/2 distributing valve one can switch over from one pressure value to the other. The control system is adjusted so that the systolic pressure remains for 100 ms and that the diastolic pressure remains for the rest of the period, dependent on the pulse beats per minute.

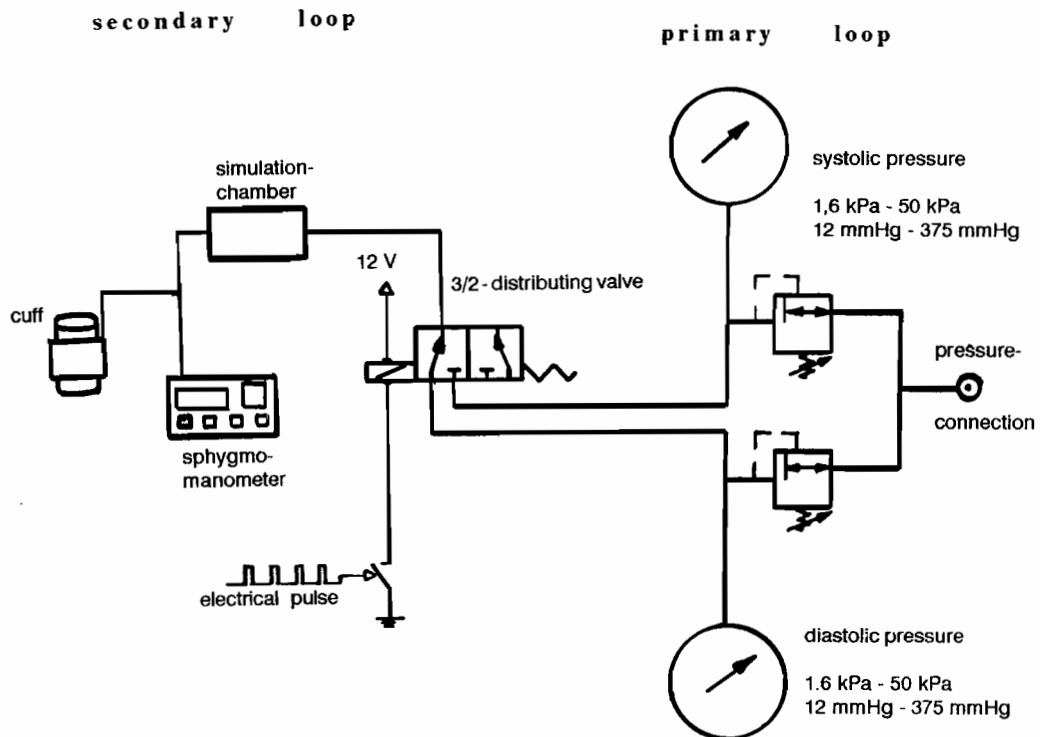

Fig. 6 - Pneumatic control loop producing oscillations and the generating of a characteristic envelope curve

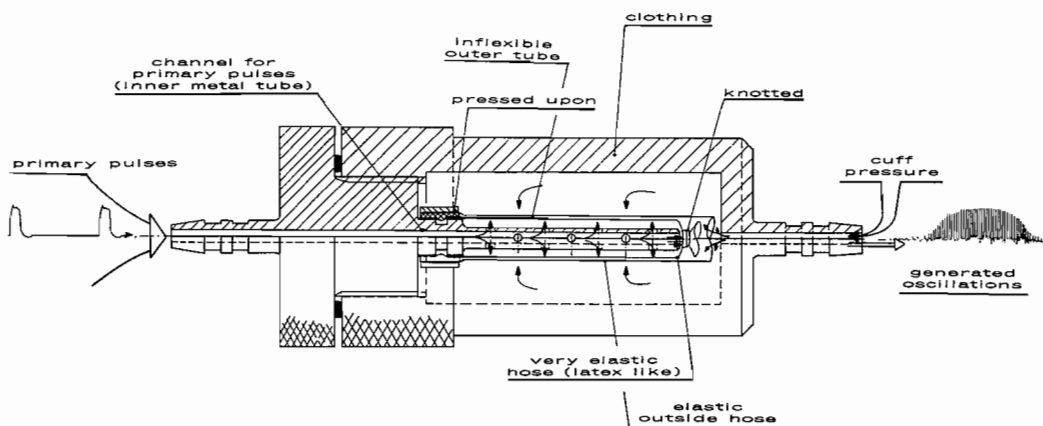

Fig. 7 - Simulation chamber

#### 4.2.2 The "Simulation chamber"

The primary pulses are transformed into oscillations for the cuff in the "Simulation chamber" or "Tube chamber" (Fig. 7).

The primary circuit is coupled tightly with the oscillatory circuit by a thinwalled, very elastic hose (at a load of 100 g the hose stretches from 100 cm to 150 cm). Tightness is reached with a rigid coating that is pressed upon one end of the hose whereas the other end is knotted. It is important that the elasticity of the hose is sufficient, so that it does not resist too much to compression and extension.

#### 4.2.3 Coupling of the primary pulses with the elastic tube system and the cuff - Production of oscillations

By inflation of the cuff with a pressure higher than the adjusted systolic pressure, the hose is constricted to the porous inner metal tube. The primary pulses have only little effect. The knotted end can swing elastically - small oscillations are transferred (preoscillations). At deflation of the cuff pressure the hose's cross section is widened for the short period of the primary pulse (like in the brachial artery at systolic pressure). The superimposed oscillation is clearly growing.

At further deflation of the cuff pressure the expansion increases and the full amplitude of the oscillations can be reached.

If deflation continues down to the diastolic pressure, the cuff pressure will be too small to constrict the hose completely and the oscillations will become clearly smaller.

When the cuff pressure has become smaller than the diastolic pressure, the hose has reached its full cross section and it would expand like a balloon if the outside wall did not prevent it. This outside wall is a thick-walled but elastic hose, so it prevents the efforts of expansion to a large extent but not entirely, like for a rigid wall. This guarantees that small variations in pressure are transferred to the pneumatic system cuff/sphygmomanometer even after the diastolic pressure has been reached (postoscillations).

The amplitude height of the oscillations is varied and optimized by the adaptation of the inner metal tube in length and cross section.

## 5. Result

By the aid of an especially developed simulation chamber it has been possible to reconstruct the oscillations and the envelope curve of a real blood pressure measurement (fig. 5).

The turning points of the envelope curve correspond in fact to values adjusted for systolic and diastolic pressure, which verifies the oscillometric method according to objective criteria. Moreover the simulation has shown that the maximum pulse corresponds to the MAP determined with the method of approximation (equation 1).

The type approval tests carried out in the Bundesamt für Eich und Vermessungswesen for oscillometric sphygmomanometers have shown a good correspondence to the values of the Riva-Rocci/Korotkoff method (Fig. 8).

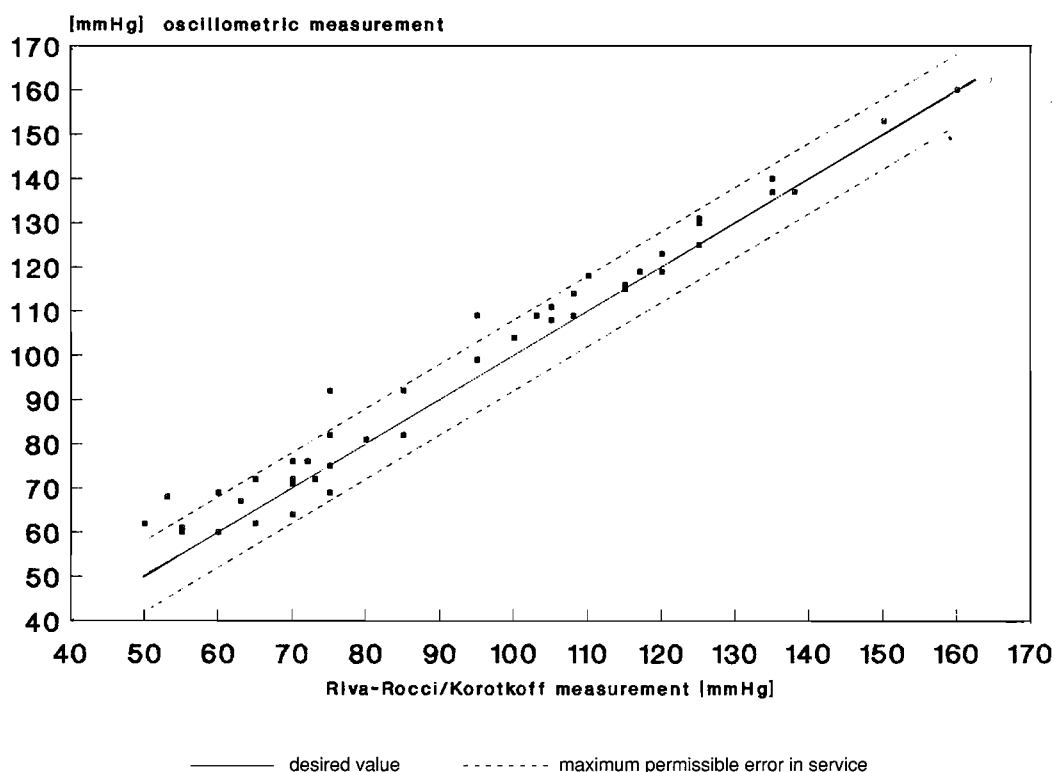

Fig. 8 - Comparison of blood pressure measurement according to Riva-Rocci/Korotkoff (measurement with stethoscope) with oscillometric method

The "outliers" are traceable to measuring errors in the Riva-Rocci/Korotkoff method, by which the diastolic pressure values cannot always be heard very well. In any case the values determined depend on the auditory acuity of the person measuring.



An even better correspondence was obtained by the simulation (fig. 9), which shows that the oscillometric blood pressure measurement delivers values for systolic and diastolic pressures according to objective criteria. A few measuring errors that may occur with the Riva-Rocci/Korotkoff method (microphone not correctly put on, error in hearing) do not appear any more.

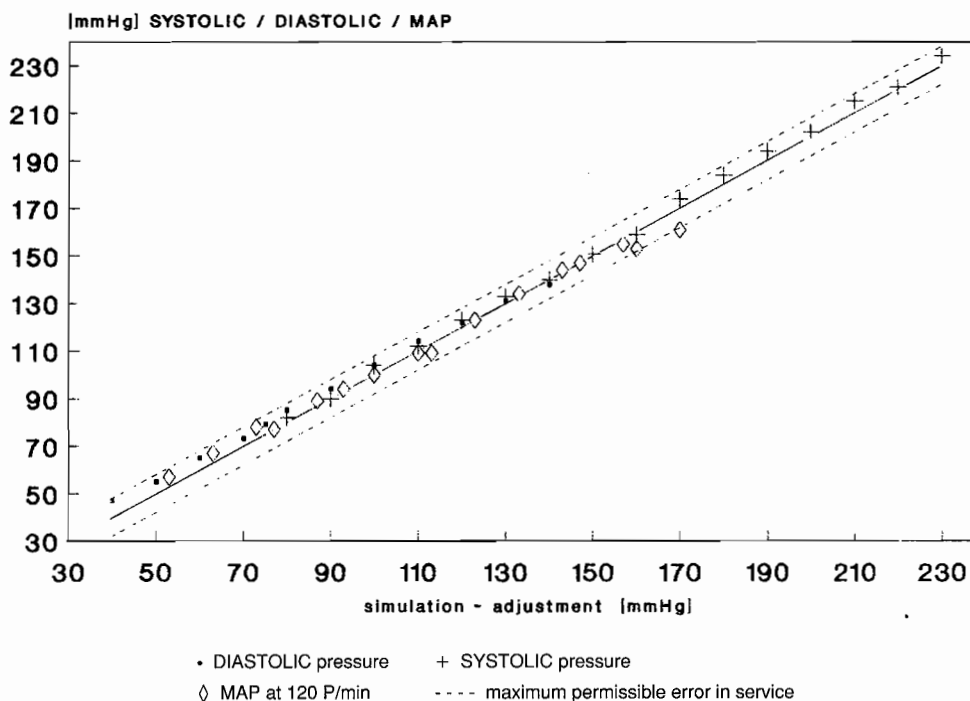

Fig. 9 - Comparison of the values adjusted on the simulation apparatus with the values determined by the sphygmomanometer for systolic and diastolic pressure and MAP

It can be considered as the very advantage of the simulation method that the whole spectrum of possible values (high and low blood pressure, blood pressure in shock, ...) can be tested without test persons and that the values can be attributed clearly to diastolic or systolic pressure.

All types of oscillometric instruments of different manufacturers tested up to now could determine the values simulated with a maximum dispersion of  $\pm 8$  mmHg, within the whole measuring range, independent of the evaluation method and even if the cuff pressure was deflated in steps. The reproducibility of measurements was  $\pm 1$  mmHg.

## 6. Verification

The simple verification of oscillometric sphygmomanometers is another pleasant fact. Instead of checking each factor separately like pressure sensor, electronics, evaluation logic, software, indication etc. - which still does not give any information if the system evaluates the oscillations correctly - one only has to adjust a pair of values for systolic and diastolic pressure at any pulse frequency and to carry out a normal blood pressure measurement.

The instrument only has to indicate the adjusted values within the maximum permissible errors and this already proves its correct function.

## 7. Conclusion

The described model for the simulation of oscillometric blood pressure measurement developed by the author separates primary pulses from the oscillations generated in the cuff with the aid of a "tube chamber". The physiological processes of a blood pressure measurement are simulated by physical-technical means and the characteristic oscillations are generated in the cuff with their corresponding envelope curve. The oscillations generated in the cuff are adapted to reality in shape and envelope curve by variation in length and cross section of the chosen inner tube, the elastic hose, and the rigid and the elastic covering.

Since the primary pulses are produced separately from the oscillations generated in the cuff, any pair of values for systolic and diastolic pressures, traceable to standard pressure values, can be adjusted. Once the "tube chamber" is adjusted correctly, no variations are necessary to generate the corresponding envelope curves for the different pairs of values.

The correctness of the indication, of blood pressure values can be examined during the subsequent verification.

The author expresses his thanks to all his colleagues, especially to Dipl.-Ing. M. Macek and Dr R. Lewisch for their valuable suggestions and their assistance at the development of the model.

## Literature

- [1] Auerswald W.: Lehrbuch der Medizinischen Physiologie.
- [2] Holzgreve H.: Forum hypertonicum, Blutdruckmessung. NMW Medium Verlag, München 1981.
- [3] Ramsey M.: Testing of noninvasive blood pressure measuring devices by comparison with invasive blood pressure measurements. Applied Medical Research.
- [4] AAMI - American National Standard; Electronic or Automated Sphygmomanometers, February 27, 1987.
- [5] Unpublished algorithms and technical details for sphygmomanometers measuring according to the oscillometric method and clinical tests kindly let for research purposes by the firms Criticon, ELMED, HP, NISSEI, Siemens.
- [6] Dagwin T.: Strömung und Geräusch in verengten und verzweigten Gefässen.
- [7] Prandtl L., Oswatitsch K., Wieghardt K.: Führer durch die Strömungslehre. Vieweg Verlag.
- [8] Non-invasive techniques for measuring blood pressure. Paramed Technology, Inc.
- [9] The differential sensor technique for measuring blood pressure. Paramed Technology, Inc.
- [10] Gross H., Ulbrich M.: Pulswellensimulation zur Prüfung von oszillometrisch messenden Sphygmomanometern. PTB-Mitteilungen 100 5/1990.
- [11] Tömböl H.: Theorie und Simulation der oszillometrischen Blutdruckmessung. EVM (Eich- und Vermessungsmagazin) Nr. 63, März 1991, p. 23.

**AUSTRALIE**

## **PATTERN APPROVAL AND VERIFICATION OF A VAPOUR RECOVERY FLOWMETERING SYSTEM\***

by **Ian M. HOERLEIN**

National Standards Commission

*SUMMARY – The vapour recovery flowmetering system described in this paper consists of two flowmeters which measure the quantity of liquid entering and leaving a vapour recovery unit. The difference between the two measurements is the quantity of vapour recovered as liquid. To ensure that the relatively small difference between the large quantities measured by each flowmeter was within the required accuracy limits, each flowmeter output was linearised. In addition the volume was converted from the measured volume at operating temperature to a volume at the standard temperature of 15 °C.*

*Pattern approval of the system consisted of evaluating the two turbine flowmeters and the linearisation and temperature conversion functions of the microprocessor-based indicator.*

*Verification of the system consisted of proving one flowmeter (supply) against a compact prover by conventional methods but using a reduced maximum permissible error for the linearised output. The output of the other meter (return) was then compared and adjusted to be within the required maximum permissible error for the difference between the two meters. The system was verified with and without the temperature conversion device activated and the difference was within the maximum permissible error.*

*Careful attention to detail in the design of the equipment and the pattern approval and verification methods are necessary to ensure that the relative error of the small difference between two large measured quantities is within acceptable limits.*

### **1. Introduction**

Within Australia the National Standards Commission has, as one of its responsibilities, the approval of the pattern (design) of measuring instruments used for trade purposes. This process involves examining and testing sample instruments and then issuing certificates of approval. The instruments are tested to design specifications issued by the Commission which are based on requirements of the International Organisation of Legal Metrology.

The verification and re-verification of instruments used for trade purposes are carried out by verifying authorities. The relationship of the Commission and verifying authorities with other Australian and international metrological organisations is described in a booklet published by the Commission "The National Measurement System of Australia" [1].

---

(\*) This paper was presented at the Conference of Flow Measurement in Industry and Science, organised by IBC Technical Services Ltd and held at the Cumberland Hotel in London on 14-15 May 1991.

Since 1981 there has been a requirement to control gasoline vapours released during both loading of road tankers at terminals and depots and unloading at service stations in Sydney and Melbourne. Vapour recovering units have been installed and a metering system has been developed to measure the quantity of vapour recovered as liquid. The measurement is necessary as the recovered vapour is effectively sold and taxed twice. By measuring the quantity of vapour recovered, a rebate on excise and costs can be calculated. Also the measurement assists in inventory control by oil companies.

A vapour recovery system was submitted to the Commission for approval of the pattern [2]. Laboratory tests were carried out on the components of the instrument and the complete instrument was also tested on-site. Because of the unusual nature of the instrument, special test procedures were developed to enable verification of the instrument by verifying authorities.

## 2. Description of the vapour recovery flowmetering system

Figure 1 shows the vapour recovery flowmetering system, including the meters and indicator.

The vapour recovery unit requires a continuous supply of liquid:

- (a) to convey the recovered liquid back to storage; and
- (b) to transfer the heat generated by the carbon absorption process and the vacuum pumps (used to regenerate the carbon) away from the vapour recovery unit.

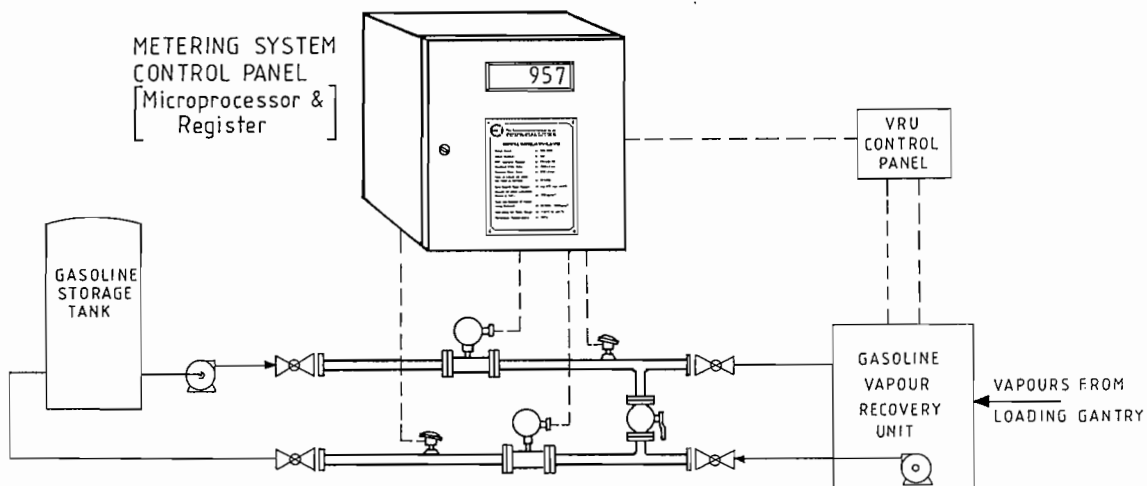

Fig. 1 - Vapour recovery flowmetering system

The recovered liquid is mainly made up of the more volatile components of gasoline. To ensure that the liquid is effectively recovered without changing the specification of the gasoline outside the limits, it is diluted into a larger volume of liquid (typically 1 % recovered liquid).

Gasoline is pumped from the storage tank through a turbine meter to the vapour recovery unit (see Figure 1) at a typical rate of 1 050 L/min. After absorbing the recovered liquid, the gasoline is pumped back to the storage tank through a second meter at a typical rate of 1 060 L/min. As heat is absorbed in the process, the temperature of the liquid is measured at both meters and the two quantities are converted to volume at a reference temperature of 15 °C. The output of both meters is also linearised over the flow rate range. The difference between the linearised, converted volumes indicated by the two meters gives the volume of the vapour recovered as liquid at 15 °C.

The fact that this difference is quite small (1 %) compared with the quantity measured by the two meters, presents the problems of calibration and verification of the flow metering system.

### **3. Pattern approval**

The three major components submitted to the Commission for pattern approval were:

- (a) the turbine flowmeters;
- (b) the temperature-measuring transducers; and
- (c) the microprocessor and indicator.

#### **3.1 Turbine Flowmeters**

The turbine flowmeters were tested on the Commission's flowmeter test facility (see Figure 2). This consists of a 4 500 L overhead supply tank, a variable speed positive-displacement pump of 4 000 L/min capacity, a test stand with straight lengths of inlet and outlet pipe, and a Brooks compact volume prover of 60 L capacity.

The meters were tested with flow conditioning equipment recommended by the manufacturer and this was included in the approved pattern.

The test facility has provisions for changing the test liquid so that performance of the meter at different viscosities can be ascertained. This ensures that the meter is capable of remaining within the specified limits over a range of viscosities likely to be met under normal operating conditions. The liquids can also be heated to some extent by forced circulation at maximum flow rate so that the effects of temperature and viscosity changes can be determined.

The Commission specifies three maximum permissible errors for flowmeters under different operating conditions:

- (a)  $\pm 0.15$  % for constant flow rate, temperature and viscosity;
- (b)  $\pm 0.3$  % for constant temperature and viscosity but over a five to one flow rate range;
- (c)  $\pm 0.5$  % over a range of temperatures (5 °C to 40 °C), equivalent viscosity and over a five to one flow rate range.

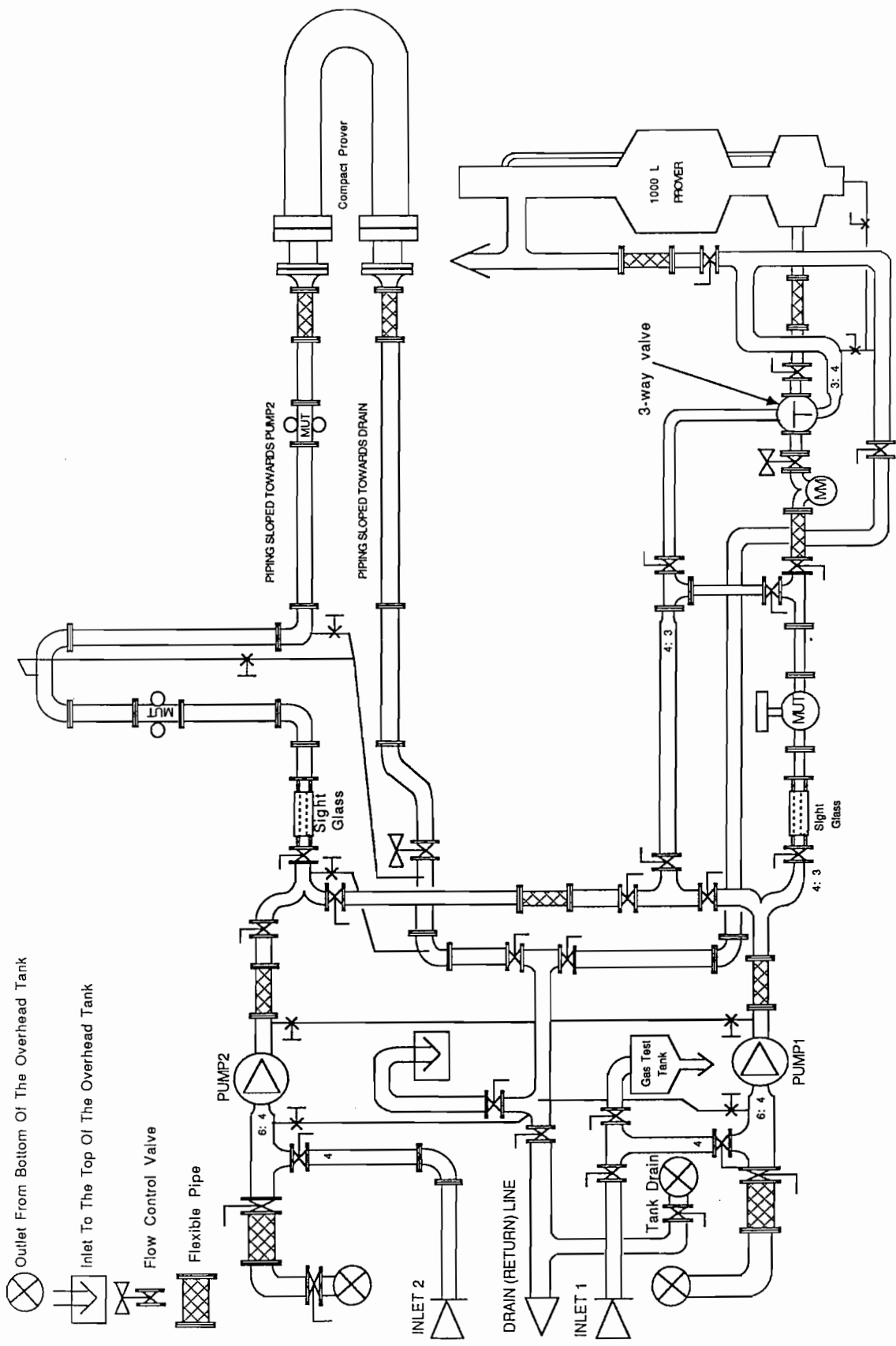

Fig. 2 - The Commission's flowmeter test facility

Figure 3 shows two typical curves for a turbine meter at two different viscosities and temperatures.

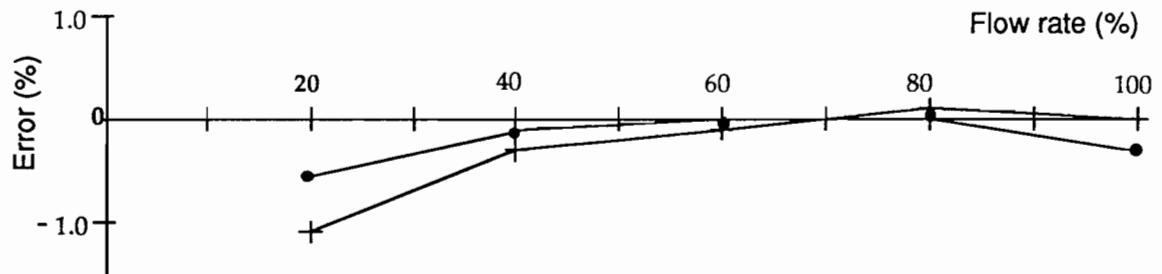

Fig. 3 - Turbine meter flow curves  
 ●● viscosity 3.9 mPa.s at 40 °C  
 ++ viscosity 5.2 mPa.s at 20 °C

### 3.2 Temperature-measuring Transducers, the Microprocessor and Indicator

The temperature-measuring transducers, microprocessor and indicator were submitted and tested as one unit to ensure that the following functions operated correctly under expected operating conditions:

- (a) stability of the indication of the two measured quantities and the difference quantity;
- (b) linearisation; and
- (c) temperature conversion.

The unit was tested under simulated conditions in the laboratory as shown in Figure 4.

The meter pulse was simulated by a pulse generator and a pulse counter was used to measure the number of pulses applied for the test.

The supply voltage to the unit was controlled through a variable transformer and measured on a voltmeter.

The temperature transducer was immersed in a controlled temperature bath with a reference thermometer.

The unit was tested in a temperature controlled cabinet and the reference pulse generator and pulse counter were kept at 20 °C.

#### 3.2.1 Stability of Indicators

The three indicators were tested for stability under varying conditions of pulse rate, ambient temperature and voltage supply. Tests were first carried out over the frequency range for which the instrument is designed (and specified in the approval) at reference conditions of 20 °C ambient temperature and 240 V a.c. supply.

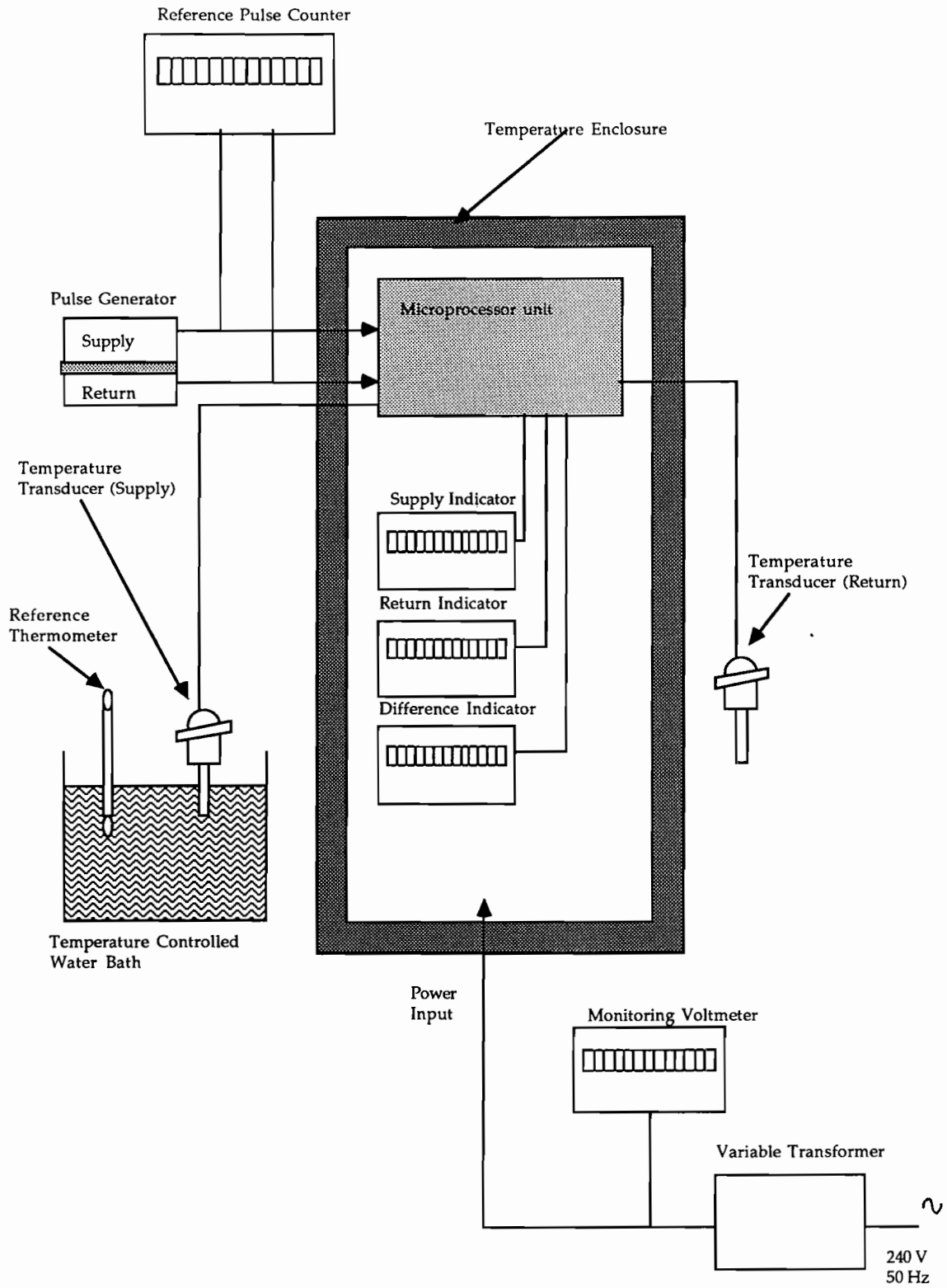

Fig. 4 - Simulated conditions for the laboratory test



Sufficient pulses were applied to the instrument to ensure adequate resolution of the indicators. The difference between the indicator and the reference pulse counter gave the error under those conditions.

The supply voltage was then successively changed to the extreme limits specified (204 V and 264 V) and the instrument was tested over the frequency range at 20 °C ambient temperature.

The ambient temperature was then successively changed to - 10 °C and 40 °C and the complete test sequence was repeated.

All results obtained were checked to ensure they were within the maximum permissible error of  $\pm$  half a scale interval.

### 3.2.2 Linearisation

Linearising function was checked by setting up a non-linear curve for the indicator using the maximum number of set points and the maximum and minimum adjustments.

The instrument was tested at a number of input frequencies which differed from those used as set points to see if the curve produced by the instrument agreed with the set curve. A sample curve was drawn (see Figure 5) and a series of histograms constructed to provide a "best fit" correction of the non-linearity. From the histogram, non-linear correction factor 1 (NLCF1) was set at frequency 1 (FREQ1) and so on to NLCF8 at FREQ 8.

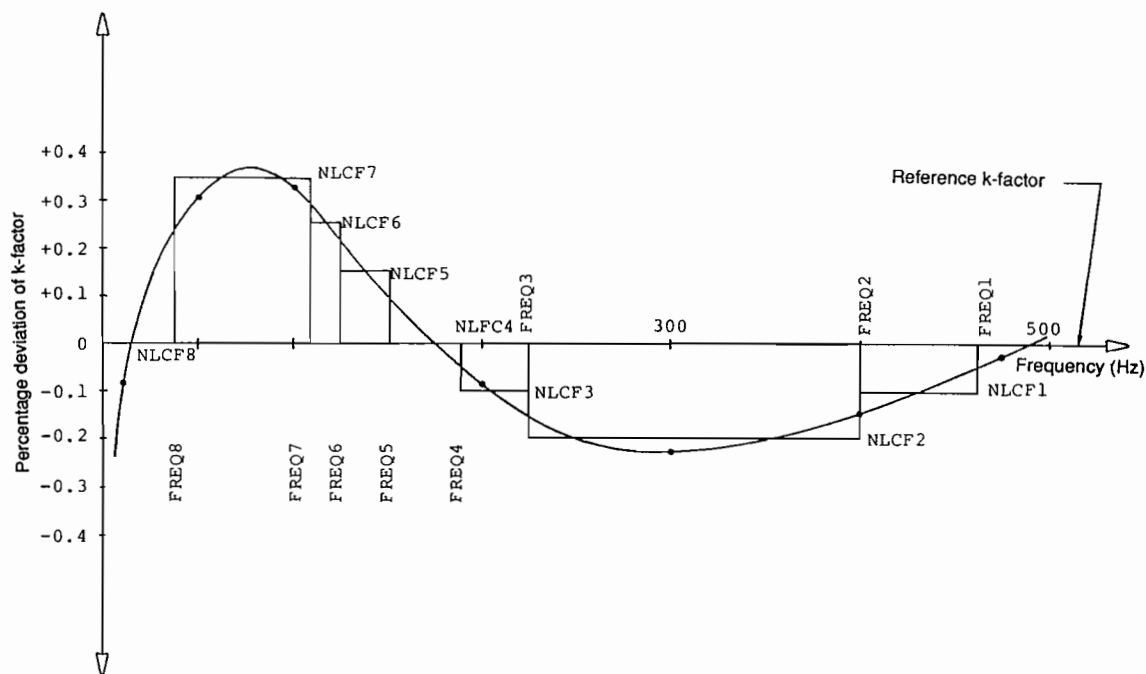

Fig. 5 - Linearisation

To check the curve, a constant number of input pulses were applied at different frequencies (indicated by the dots on the curve) and the percentage deviation obtained was compared with the original curve. The difference was found to be within the maximum permissible error of  $\pm 0.05\%$ .

### 3.2.3 Temperature Conversion

The temperature conversion function was checked by comparing the indicated converted volume against a calculated converted volume (obtained from the indicated unconverted volume) and the volume correction factors (obtained from reference tables and the temperatures obtained from the reference thermometer).

The temperature conversion device was tested for a range of density settings, liquid temperatures, frequency inputs, ambient temperatures and voltage supplies.

Figure 4 illustrates the simulated test arrangement. The relative error of the difference between the indicated and calculated converted volumes was calculated and compared with the maximum permissible error of  $\pm 0.2\%$ .

This test highlights any errors that are due to the temperature transducer and the information contained in the microprocessor which carries out the conversion.

## 4. Verification

To complete the pattern approval examination and to provide for future verification of the instrument, a procedure was developed to test the complete instrument in the field.

Some typical operational figures for the instrument were:

- (a) meter scale interval, 10 L
- (b) meter test scale interval, 1 L
- (c) flow rates, 850-1 080 L/min
- (d) quantity metered per day, 1 000 000 L
- (e) quantity recovered per day, 10 000 L, and
- (f) quantity recovered per month, 300 000 L.

If the two meters were calibrated separately without reference to each other to say  $\pm 0.15\%$  (using linearisation), there was a possibility that the error between the metered quantities could be of the order of 0.3 % of the metered quantity. As the difference quantity was 1 % of the metered quantity, the error of the difference could be up to 30 % of the difference quantity.

To overcome this problem, the method adopted was to verify the supply meter against a traceable volumetric standard and then verify the return meter against the supply meter to ensure minimum difference between the two meters.

#### 4.1 Test Procedure and Results

The supply turbine meter was tested against a master meter at three flow rates of 850, 950 and 1 050 L/min using a test quantity of 10 000 L. The 1 L test scale interval of the turbine meter was used with a 0.1 L scale interval of the master meter. The vapour recovery unit was bypassed for the test and the temperature conversion device was deactivated. The results after linearisation are shown in Table 1.

TABLE 1 - METER RESULTS AFTER LINEARISATION

Flow rate (L/min)	Meter error (%)	Repeatability (%)
850	- 0.041	0.007
950	- 0.063	0.005
1 050	- 0.054	0.009

The maximum permissible error using linearisation was  $\pm 0.15$  % with an allowable repeatability of 0.15 %. The meter was therefore satisfactory.

The meter was also tested with the temperature conversion device activated with a liquid temperature of 22.3 °C and a flow rate of 950 L/min. The meter error was + 0.015 %. The maximum permissible error for the converted volume with linearisation was  $\pm 0.35$  % [ $\pm (0.15 + 0.2)$  %].

Liquid was circulated through both meters without passing through the vapour recovery unit and the readings from both meters were compared. Once again approximately 10 000 L minimum was used with a test scale interval of 1 L. The temperature conversion device was deactivated for the first series of tests. The meters were compared at various flow rates as shown in Table 2.

TABLE 2 - METERS COMPARED AT THREE DIFFERENT FLOW RATES

Flow rate (L/min)	Supply meter (L)	Return meter (L)	Difference (L)
866	8 660	8 660	0
1 022	20 440	20 441	1
1 078	10 770	10 770	0

A maximum permissible error of  $\pm 0.01$  % of the quantity measured by the return meter when compared with the supply meter was aimed for and achieved. This is the smallest error possible as the k-factor adjustment was limited to 0.01 %. However this error is still 1 % of the liquid recovered as vapour as it is only 1 % of the quantity measured by each meter.

A further test was carried out at the normal flow rate with the temperature conversion devices for each meter activated and the result obtained is shown in Table 3. This result was also considered satisfactory.

TABLE 3 - METERS COMPARED WITH TEMPERATURE CONVERSION DEVICE ACTIVATED

Flow rate (L/min)	Supply meter (L)	Return meter (L)	Difference (L)
980	19 890	19 891	1

## 5. Conclusions

This paper describes the methods used by the Commission for pattern approval and verification of flowmeters and auxiliary equipment such as temperature conversion devices and linearisation devices. The various components and functions of the instrument were tested separately with separate maximum permissible errors.

It is impossible to obtain equivalent relative accuracy on the difference between two meters compared with the measurement by each meter. The methods described achieved the best results possible and acceptable to the parties involved.

## References

- [1] "The National Measurement System of Australia", ISBN: 0 642 07423 2. National Standards Commission.
- [2] Pattern Approval Manual N° 2: Liquid-measuring Systems for Trade Use (1988). National Standards Commission.

## INFORMATIONS

### MEMBRES DU COMITÉ – CIML MEMBERS

RÉPUBLIQUE FÉDÉRATIVE TCHÈQUE ET SLOVAQUE – Le nouveau Membre du CIML pour la Tchécoslovaquie (qui remplace donc Monsieur M. CIBAK) est Monsieur A. KURUC, Directeur du Service d'Inspection d'État pour la Métrologie.

*FEDERAL REPUBLIC OF CZECHOSLOVAKIA – The new CIML Member for Czechoslovakia (who thus replaces Mr M. CIBAK) is Mr A. KURUC, Director of the Service for State Supervision for Metrology.*

**CHINE** – Monsieur Deng ZUBIN de Shenyang Institute of Instrumentation Technology a construit un équipement d'essai pour déterminer les caractéristiques de jauges contraintes objet de la Recommandation OIML R 62.

Les données techniques de cet appareil, qui est actuellement commercialisé, sont indiquées ci-dessous dans la version anglaise.

**CHINA** – *Mr Deng ZUBIN of the Shenyang Institute of Instrumentation Technology has developed a test equipment for strain gauges subject to OIML Recommendation R 62.*

*This highly accurate calibration apparatus is used to produce the standard static strain for calibration of the normal temperature strain gauge factor, mechanical hysteresis, creep and transverse sensitivity.*

*The apparatus is based on the principle of rigid-frame beam. Its calibration beam can be conveniently deformed towards positive and negative directions in one clamping and has a long uniform bending-moment field. It can be automatically loaded and unloaded with two steps of speed and accurately located manually. It has two functions, i.e. the reset self-checking function and the measuring process self-checking function.*

*Other technical data at  $23 \pm 1$  °C are as follows:*

- *For the mechanical strain on the calibration beam surface of 1 000  $\mu\text{m}/\text{m}$ :*
  1. *The precision is 0.2 %.*  
*(after the systematic error has been corrected).*
  2. *The uniformity of the strain distribution within 150 mm is 0.2 %.*
  3. *The repeating accuracy is 0.1 %.*
- *The maximum permissible strain on the calibration beam surface is 3 000  $\mu\text{m}/\text{m}$ .*
- *The strain accuracy in the deflection measuring method is 0.05 %.*
- *The dimensions of the apparatus: 1 760 × 1 000 × 700 mm.*
- *Weight of the apparatus: 800 kg.*
- *Power supply: 380 V, A.C.*

*For more details about the commercialized version of this equipment contact*

*Mr Deng ZUBIN  
Shenyang Institute of Instrumentation Technology  
242, Beihai Street, Dadong District,  
110043 Shenyang, China*

**CUBA** – Le Comité d'État de Normalisation (CEN) propose aux pays étrangers de nombreux services dans les domaines de la métrologie et de la normalisation; on peut en particulier noter les suivants:

- création, organisation et développement de systèmes de formation de personnel,
- organisation de cours de formation à Cuba concernant les activités de normalisation, métrologie et qualité,
- organisation de cours de formation dans d'autres pays et enseignement par des spécialistes du CEN,
- étalonnage et vérification des moyens de mesure,
- intercomparaison des étalons et certification des moyens de référence,
- programmes communs de recherche en métrologie appliquée,
- planification de laboratoires nationaux et régionaux et de centres de métrologie,
- études sur l'assurance de la qualité dans différentes branches de l'économie et entreprises de fabrication ou de maintenance,
- création de services d'information technique et scientifique dans le domaine de la normalisation, la métrologie et l'assurance de la qualité,
- traductions de normes et documents techniques dans le domaine de la métrologie et de la qualité en différentes langues, en particulier espagnol, anglais et français,
- vente de programmes pour le traitement, la mise en mémoire et l'accès d'informations techniques sur la normalisation et la qualité.

**CUBA** – *The State Committee for Standardization (CEN) can offer numerous services to foreign countries in the field of metrology and standardization among which one may note the following:*

- *Creation, organization and development of staff training systems,*
- *Organization of training in Cuba about activities on standardization, metrology and quality,*
- *Organization of training courses in other countries and teaching by CEN's staff,*
- *Calibration and verification of measurement means,*
- *Intercomparison of standards and certification of reference means,*
- *Development of joint research on applied metrology,*
- *Projection of national or local laboratories and metrological centers,*
- *Study on measurement assurance in the different branches of the economy, and industrial and service enterprises,*
- *Creation of the scientific-technical information services on activities in standardization, metrology and quality control,*
- *Translation service of standards and technical documents related to metrology and quality, in different languages, particularly Spanish, English and French,*
- *Sale of programs for the processing, storage and retrieval of scientific and technical information on standardization and quality.*

## SYSTÈME DE CERTIFICATS OIML POUR LES INSTRUMENTS DE MESURE

### OIML CERTIFICATE SYSTEM FOR MEASURING INSTRUMENTS

Une description du Système de Certificats OIML a été donnée dans le Bulletin OIML n° 122 - Mars 1991 et des listes d'autorités de délivrance désignées par certains États Membres ont été données dans les Bulletins n° 122 et n° 124.

Nous rappelons que ce Système s'applique actuellement aux catégories d'instruments de mesure des Recommandations Internationales OIML suivantes: Poids (R 1, 2 et 20), Instruments de pesage à fonctionnement non automatique (R 76 - nouvelle édition en cours de publication), Baromètres (R 97) et Mesures matérialisées de longueur à traits de haute précision (R 98).

Depuis la parution du Bulletin n° 124, les deux États suivants ont désigné des autorités de délivrance:

#### Royaume-Uni/*United Kingdom*

National Weights and Measures Laboratory	R 1, R 2, R 20 R 76, R 98
National Physical Laboratory	R 97

#### Tchécoslovaquie/*Czechoslovakia*

Monsieur A. Kuruc	R 1, R 2, R 20
Directeur du Service d'Inspection d'État pour la Métrologie	R 76, R 97, R 98

On trouvera dans le tableau ci-dessous une récapitulation de tous les États Membres ayant, jusqu'à ce jour, désigné des autorités de délivrance. Sauf mention particulière, des certificats OIML peuvent être délivrés, dans ces États, pour toutes les catégories d'instruments mentionnées ci-dessus. Il est rappelé que, dans tous les cas, les demandes de certificats doivent être adressées au Membre du CIML d'un des États du tableau ci-dessous (voir noms et adresses en fin de Bulletin).

*A description of the OIML Certificate System together with lists of issuing authorities was published in the OIML Bulletins n° 122 and 124.*

*We remind you that this System presently applies to the categories of measuring instruments subject to the following OIML International Recommendations: Weights (R 1, 2 and 20), Nonautomatic weighing instruments (R 76 - new edition in print), Barometers (R 97) and High-precision line measures of length (R 98).*

*Since the publication of Bulletin n° 124, the following States have designated issuing authorities:*

#### *United Kingdom*

<i>National Weights and Measures Laboratory</i>	<i>R 1, R 2, R 20 R 76, R 98</i>
<i>National Physical Laboratory</i>	<i>R 97</i>

*Federal Republic of Czechoslovakia*

*Mr A. Kuruc  
Director of the State Inspection Service for Metrology*

*R 1, R 2, R 20  
R 76, R 97, R 98*

*You will find in the table below a list of all Member States which have to this date designated issuing authorities. With the exceptions specially mentioned, all these Member States may issue OIML certificates for all the presently applicable categories of instruments.*

*All applications for OIML certificates shall be sent to the CIML Member in the countries listed in the table (see names and addresses by the end of this Bulletin).*

### **États Membres ayant désigné des autorités de délivrance**

*Member States having appointed issuing authorities*

*Allemagne/Germany*

*Belgique/Belgium*

*R.P. de Chine/P.R. of China*

*Danemark/Denmark (\*)*

*Espagne/Spain*

*France*

*Hongrie/Hungary*

*Norvège/Norway(\*\*)*

*Pays-Bas/Netherlands*

*Roumanie/Romania*

*Royaume-Uni/United Kingdom*

*Suède/Sweden (\*)*

*Tchécoslovaquie/Czechoslovakia*

*U.R.S.S./U.S.S.R.*

*(\*) sauf pour R 97 / R 97 excepted.*

*(\*\*) sauf pour R 97 et R 98 / R 97 and R 98 excepted.*



## RÉGLEMENTATION MÉTROLOGIQUE DANS LE CADRE DE CEE ET AELE

Une liste des Directives adoptées dans le domaine de la métrologie par le Conseil des Communautés Européennes avait été publiée dans le Bulletin OIML n° 106 - Mars 1987. Ce même numéro du Bulletin contenait également des informations sur les divers forums de coopération métrologique en Europe, y compris sur la "nouvelle approche" utilisée depuis lors dans le cadre de la Communauté Européenne pour développer des Directives réduites aux exigences essentielles et complétées par des Normes Européennes élaborées par les comités européens de normalisation, CEN et/ou CENELEC.

Il est à noter que les pays membres de l'Association Européenne de Libre Échange ont décidé d'adopter en principe les mêmes réglementations que les pays de la Communauté Européenne et de mettre en application les mêmes normes européennes d'accompagnement aux Directives de la Communauté Européenne.

Certaines des Directives dont la liste a été publiée dans le Bulletin n° 106 ont seulement fait l'objet de quelques légers amendements. Par contre, il faut noter que la Directive 73/360 sur les instruments de pesage à fonctionnement non automatique a été remplacée par la Directive "nouvelle approche" 90/384. La norme d'application à cette Directive est en voie d'achèvement dans le cadre d'un groupe de travail mixte CEN/CENELEC. Elle a été préparée en très étroite collaboration avec le Secrétariat Rapporteur OIML SP 7-Sr 4 et le BIML, ce qui assure la complète compatibilité de cette future norme européenne (et donc de toutes les normes nationales qui seront automatiquement publiées dans les pays de la CEE et de l'AELE) avec la nouvelle édition de la R 76 (actuellement en cours de publication).

Les lecteurs "non européens" de notre Bulletin seront également intéressés d'apprendre que la Commission des Communautés Européennes travaille actuellement à la préparation d'une "Directive métrologique horizontale" qui devrait fixer les exigences essentielles pour tous les instruments de mesure soumis ou susceptibles d'être soumis à des contrôles légaux dans les pays de la CEE (avec, vraisemblablement, développement d'une réglementation similaire dans les pays de l'AELE).

Sur la base de cette Directive horizontale, les comités européens de normalisation CEN/CENELEC seront appelés à développer des Normes Européennes donnant, pour chaque catégorie d'instruments de mesure soumis aux contrôles, des solutions permettant de satisfaire à la Directive horizontale. L'OIML s'efforcera bien sûr de coopérer activement avec le CEN et le CENELEC de telle manière que ces Normes Européennes, et les Recommandations OIML correspondantes, soient totalement compatibles entre elles. Le CEN et le CENELEC ont d'ores et déjà commencé à travailler dans des domaines tels que les compteurs de gaz et les taximètres électroniques, ces travaux européens se déroulant avec la participation d'experts de l'OIML.

## METROLOGY REGULATIONS WITHIN THE FRAMEWORK OF EEC AND EFTA

A list of Directives adopted by the Council of the European Communities was published in the OIML Bulletin n° 106 - March 1987. The same issue contained also information on the various forums of metrological cooperation in Europe and on the "new approach" thereafter applied within the framework of the European Communities to develop Directives limited to the most essential requirements and completed by European Standards produced by the European committees for standardization CEN and/or CENELEC.

It is to be noted that the countries members of the European Free Trade Association (EFTA) have decided to adopt the same regulations as those of the European Communities and to apply the same European Standards accompanying the Directives of the European Communities.

Some of these Directives the list of which was published in the OIML Bulletin n° 106 have been only slightly amended. However, it should be noted that the Directive 73/360 on non-automatic weighing instruments has been entirely replaced by the "new approach" Directive 90/384. The corresponding application standard to this Directive is being finalized by the combined CEN/CENELEC working group. The draft has been prepared in very close cooperation with the OIML Reporting Secretariat SP 7-Sr 4 and BIML, a fact which ensures the full compatibility of this future European standard (and thus of all the national standards which will be published within the EEC and EFTA countries) with the new edition of R 76 (presently in print).

The non-European readers of our Bulletin may also be interested to know that the Commission of the European Communities presently prepares an "horizontal" metrological Directive which will cover the essential requirements for all measuring instruments likely to be subject to legal control in the EEC countries (with the possibility of a similar development in the EFTA countries).

On the basis of this horizontal Directive the European standardization committees CEN and CENELEC will have to develop European standards for each category of measuring instruments subject to legal control so as to present solutions in accordance with the new horizontal Directive. OIML will continue to cooperate actively with CEN and CENELEC so as to make these European Standards and the OIML Recommendations entirely compatible. The CEN and the CENELEC have already started work with participation of OIML experts within the fields of gas meters and electronic taximeters.

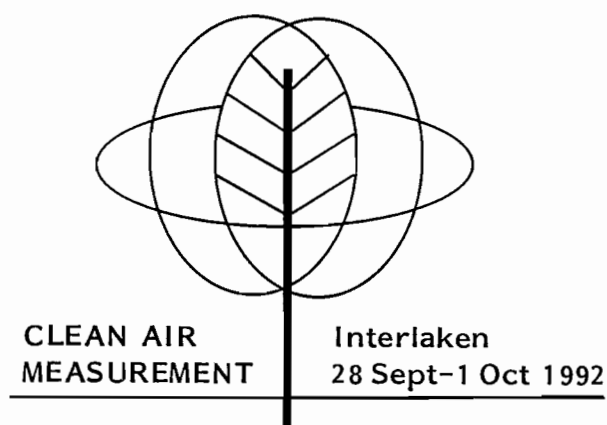

### **OIML Seminar on Instruments for Measuring Air Pollution**

The scope of OIML technical seminars is to brief staff in national metrology services and testing institutes about technical progress in various fields and to allow exchanges of views with specialists on problems encountered in their work.

The elaboration of future OIML Recommendations is not considered as topics of such seminars as this work is carried out within the competent technical committees (reporting secretariats). The practical application of an existing OIML Recommendation may however typically be treated in these seminars.

#### **SCOPE OF THE PRESENT SEMINAR**

Papers are invited under the following headlines:

1. Vehicle exhaust measuring instruments
  - 1.1 Principles and realization of instruments for direct measurement of vehicle exhaust pollution components.
  - 1.2 Testing for accuracy and external influences of instruments for measuring vehicle exhaust emissions.
  - 1.3 Reference and working calibration gases for instruments measuring vehicle exhaust emissions.
2. Ambient air monitoring instruments
  - 2.1 Principles and realization of automatic instruments for measuring ambient air pollution components such as SO<sub>2</sub>, NO<sub>x</sub>, CO, H<sub>2</sub>S, O<sub>3</sub>, particulates, etc.
  - 2.2 Testing of ambient air monitoring instruments for accuracy and external influences.
  - 2.3 Use of calibration gases for ambient air monitoring instruments.
3. Stationary source emission measuring instruments
  - 3.1 Principles and realization of stack emission measuring instruments for SO<sub>2</sub>, NO<sub>x</sub>, particulates, etc.
  - 3.2 Testing of instruments used for measuring stationary source emissions.

#### 4. Information about existing regulations on air pollution and their enforcement

Papers on regulatory action in various countries may also be presented in particular when they affect the required accuracy or minimum detection level of the instruments concerned.

#### ORGANIZERS

Bureau International de Métrologie Légale  
and Swiss Federal Office of Metrology.

#### LANGUAGES

All the lectures will be given in English. We regret that for economical reasons translations into other languages cannot be provided at this seminar.

#### PARTICIPATION

Participation in the seminar is open to all OIML Member States and Corresponding Member Countries as well as to those international and regional institutions in liaison with OIML which are specially concerned with instruments for measuring air pollution.

A limited number of representatives from technical universities and industry are invited to deliver lectures on the operating principles of instruments for air pollution measurements and problems related to their manufacture and calibration.

#### FEES

Participation is free of charge but all participants must provide for costs of travel and subsistence.

#### VENUE

The seminar will take place at an hotel in Interlaken which has been specially reserved and offers full accommodation including meals at the very reasonable price of 135 Swiss francs per day and per person (117 Swiss francs in double room accommodation).

#### REGISTRATION

Registration of participation is **compulsory** and should be addressed to BIML, 11 rue Turgot, 75009 Paris

**before 15 February 1992**

As the number of participants is limited, registration received after this date may not be accepted.

The acceptance of the registration will be confirmed by letter from BIML along with practical travel information.

#### ADVICE TO LECTURERS

The authors are requested to supply BIML with short summaries before 15 February 1992 and with complete texts before 31 July 1992.

## Workshop on Medical Measuring Instruments

7-18 September 1992  
Munich, Federal Republic of Germany

*Jointly organized by Physikalisch-Technische Bundesanstalt, PTB and Deutsche Akademie für Metrologie, DAM.*

*Sponsor: Bundesministerium für wirtschaftliche Zusammenarbeit, BMZ.*

In view of the success of the 1991 workshop on the same subject and the existing training demand, the course with a slightly modified programme will be repeated in 1992 at the dates indicated above for participants from developing countries.

### OBJECTIVES

To familiarize verification inspectors with the

- measuring principles
- international recommendations and standards
- verification procedures

for clinical thermometers and blood-pressure measuring instruments.

### PARTICIPANTS' QUALIFICATIONS

Participants should be employees of a national metrology service and familiar with practical verification work. Full proficiency in English is indispensable, as English will be the working language.

### APPLICATION

Application forms can be obtained from:

Physikalisch-Technische Bundesanstalt  
Gruppe 8.5, Technische Zusammenarbeit  
Postfach 33 45  
D-3300 Braunschweig  
Federal Republic of Germany  
Telex: 952 822 ptb d  
Telefax: 49 531 592 4006  
Telefon: 49 531 592 8500

The application forms shall be returned to PTB not later than 1 April 1992.

### COSTS

The organizers will cover all the costs of training, board and lodging, international travelling expenses and local transportation for a certain number of participants. Self-financing would be appreciated.

### SELECTION OF PARTICIPANTS

Preference will be given to participants from those countries that already have legal requirements for medical measuring instruments or that have already started or will start verification work in this field. Confirmation of accepted participation will be sent to applicants in June 1992.

## OIML REUNIONS – MEETINGS

<b>Groupes de travail</b> <i>Working Groups</i>	<b>Dates</b> <i>Date</i>	<b>Lieux</b> <i>Place</i>
SP 7-Sr 5 Instruments de pesage à fonctionnement automatique <i>Automatic weighing instruments</i>	18-19 Fév. 1992	TEDDINGTON ROYAUME-UNI/ UNITED KINGDOM
-----		
Conseil de la Présidence <i>Presidential Council</i>	10-12 Fév. 1992	BIML, PARIS
<i>OIML-DAM-PTB Training course in the verification of weighing instruments (in English)</i>	29 June- 10 July 1992	MUNICH GERMANY
Séminaire sur les instruments de mesure de la pollution de l'air <i>Seminar on air pollution measuring instruments</i>	28 Sept.- 1er Oct. 1992	INTERLAKEN SUISSE/SWITZERLAND
9e Conférence Internationale de Métrologie Légale (et 27e réunion du CIML) <i>9th International Conference of Legal Metrology (and 27th CIML meeting)</i>	2-6 Nov. 1992	VOULIAGMENIS, ATHENES GRÈCE/GREECE

Note : Liste à jour fin novembre 1991  
*List as per end of November 1991*

## PUBLICATIONS

	Edition
Vocabulaire de métrologie légale <i>Vocabulary of legal metrology</i>	1978
Vocabulaire international des termes fondamentaux et généraux de métrologie <i>International vocabulary of basic and general terms in metrology</i>	en révision <i>being revised</i>
Dictionnaire des essais de dureté (français, anglais, allemand, russe) <i>Hardness testing dictionary (French, English, German, Russian)</i>	1991

## RECOMMANDATIONS INTERNATIONALES

### INTERNATIONAL RECOMMENDATIONS

R 1 — Poids cylindriques de 1 g à 10 kg (de la classe de précision moyenne) <i>Cylindrical weights from 1 g to 10 kg (medium accuracy class)</i>	1973
R 2 — Poids parallélépipédiques de 5 à 50 kg (de la classe de précision moyenne) <i>Rectangular bar weights from 5 to 50 kg (medium accuracy class)</i>	1973
R 4 — Fioles jaugées (à un trait) en verre <i>Volumetric flasks (one mark) in glass</i>	1970
R 5 — Compteurs de liquides autres que l'eau à chambres mesureuses <i>Meters for liquids other than water with measuring chambers</i>	1981
R 6 — Dispositions générales pour les compteurs de volume de gaz <i>General provisions for gas volume meters</i>	1989
R 7 — Thermomètres médicaux (à mercure, en verre, avec dispositif à maximum) <i>Clinical thermometers (mercury-in-glass, with maximum device)</i>	1978
R 9 — Vérification et étalonnage des blocs de référence de dureté Brinell <i>Verification and calibration of Brinell hardness standardized blocks</i>	1970
R 10 — Vérification et étalonnage des blocs de référence de dureté Vickers <i>Verification and calibration of Vickers hardness standardized blocks</i>	1970
R 11 — Vérification et étalonnage des blocs de référence de dureté Rockwell B <i>Verification and calibration of Rockwell B hardness standardized blocks</i>	1970
R 12 — Vérification et étalonnage des blocs de référence de dureté Rockwell C <i>Verification and calibration of Rockwell C hardness standardized blocks</i>	1970
R 14 — Saccharimètres polarimétriques <i>Polarimetric saccharimeters</i>	1978
R 15 — Instruments de mesure de la masse à l'hectolitre des céréales <i>Instruments for measuring the hectolitre mass of cereals</i>	1970
R 16 — Manomètres des instruments de mesure de la tension artérielle (sphygmomanomètres) <i>Manometers for instruments for measuring blood pressure (sphygmomanometers)</i>	1970

R 18	—	Pyromètres optiques à filament disparaissant <i>Visual disappearing filament pyrometers</i>	1989
R 20	—	Poids des classes de précision $E_1$ $E_2$ $F_1$ $F_2$ $M_1$ de 50 kg à 1 mg <i>Weights of accuracy classes <math>E_1</math> <math>E_2</math> <math>F_1</math> <math>F_2</math> <math>M_1</math> from 50 kg to 1 mg</i>	1973
R 21	—	Taximètres <i>Taximeters</i>	1973
R 22	—	Tables alcoométriques internationales <i>International alcoholometric tables</i>	1975
R 23	—	Manomètres pour pneumatiques de véhicules automobiles <i>Tyre pressure gauges for motor vehicles</i>	1973
R 24	—	Mètre étalon rigide pour agents de vérification <i>Standard one metre bar for verification officers</i>	1973
R 25	—	Poids étalons pour agents de vérification <i>Standard weights for verification officers</i>	1977
R 26	—	Seringues médicales <i>Medical syringes</i>	1973
R 27	—	Compteurs de volume de liquides (autres que l'eau). Dispositifs complémentaires. <i>Volume meters for liquids (other than water). Ancillary equipment</i>	1973
R 29	—	Mesures de capacité de service <i>Capacity serving measures</i>	1973
R 30	—	Mesures de longueur à bouts plans (calibres à bouts plans ou cales-étalons) <i>End standards of length (gauge blocks)</i>	1981
R 31	—	Compteurs de volume de gaz à parois déformables <i>Diaphragm gas meters</i>	1989
R 32	—	Compteurs de volume de gaz à pistons rotatifs et compteurs de volume de gaz à turbine <i>Rotary piston gas meters and turbine gas meters</i>	1989
R 33	—	Valeur conventionnelle du résultat des pesées dans l'air <i>Conventional value of the result of weighing in air</i>	1973
R 34	—	Classes de précision des instruments de mesurage <i>Accuracy classes of measuring instruments</i>	1974
R 35	—	Mesures matérialisées de longueur pour usages généraux <i>Material measures of length for general use</i>	1985
R 36	—	Vérification des pénétrateurs des machines d'essai de dureté <i>Verification of indenters for hardness testing machines</i>	1977
R 37	—	Vérification des machines d'essai de dureté (système Brinell) <i>Verification of hardness testing machines (Brinell system)</i>	1977
R 38	—	Vérification des machines d'essai de dureté (système Vickers) <i>Verification of hardness testing machines (Vickers system)</i>	1977



R 39	— Vérification des machines d'essai de dureté (systèmes Rockwell B, F, T - C, A, N) <i>Verification of hardness testing machines (Rockwell systems B, F, T - C, A, N)</i>	1977
R 40	— Pipettes graduées étalons pour agents de vérification <i>Standard graduated pipettes for verification officers</i>	1977
R 41	— Burettes étalons pour agents de vérification <i>Standard burettes for verification officers</i>	1977
R 42	— Poinçons de métal pour agents de vérification <i>Metal stamps for verification officers</i>	1977
R 43	— Fioles étalons graduées en verre pour agents de vérification <i>Standard graduated glass flasks for verification officers</i>	1977
R 44	— Alcoomètres et aréomètres pour alcool et thermomètres utilisés en alcoométrie <i>Alcoholometers and alcohol hydrometers and thermometers for use in alcoholometry</i>	1985
R 45	— Tonneaux et futailles <i>Casks and barrels</i>	1977
R 46	— Compteurs d'énergie électrique active à branchement direct (de la classe 2) <i>Active electrical energy meters for direct connection (class 2)</i>	1978
R 47	— Poids étalons pour le contrôle des instruments de pesage de portée élevée <i>Standard weights for testing of high capacity weighing machines</i>	1978
R 48	— Lampes à ruban de tungstène pour l'étalonnage des pyromètres optiques <i>Tungsten ribbon lamps for calibration of optical pyrometers</i>	1978
R 49	— Compteurs d'eau (destinés au mesurage de l'eau froide) <i>Water meters (intended for the metering of cold water)</i>	1977
R 50	— Instruments de pesage totalisateurs continus à fonctionnement automatique <i>Continuous totalising automatic weighing machines</i>	1980
R 51	— Trieuses pondérales de contrôle et trieuses pondérales de classement <i>Checkweighing and weight grading machines</i>	1985
R 52	— Poids hexagonaux. Classe de précision ordinaire de 100 g à 50 kg <i>Hexagonal weights. Ordinary accuracy class, from 100 g to 50 kg</i>	1980
R 53	— Caractéristiques métrologiques des éléments récepteurs élastiques utilisés pour le mesurage de la pression. Méthodes de leur détermination <i>Metrological characteristics of elastic sensing elements used for measurement of pressure. Determination methods</i>	1982
R 54	— Échelle de pH des solutions aqueuses <i>pH scale for aqueous solutions</i>	1981
R 55	— Compteurs de vitesse, compteurs mécaniques de distance et chronotachygraphes des véhicules automobiles - Réglementation métrologique <i>Speedometers, mechanical odometers and chronotachographs for motor vehicles. Metrological regulations</i>	1981
R 56	— Solutions-étalons reproduisant la conductivité des électrolytes <i>Standard solutions reproducing the conductivity of electrolytes</i>	1981
R 57	— Ensembles de mesurage de liquides autres que l'eau équipés de compteurs de volumes. Dispositions générales <i>Measuring assemblies for liquids other than water fitted with volume meters. General provisions</i>	1982

R 58	— Sonomètres <i>Sound level meters</i>	1984
R 59	— Humidimètres pour grains de céréales et graines oléagineuses <i>Moisture meters for cereal grains and oilseeds</i>	1984
R 60	— Réglementation métrologique des cellules de pesée <i>Metrological regulations for load cells</i>	1991
R 61	— Doseuses pondérales à fonctionnement automatique <i>Automatic gravimetric filling machines</i>	1985
R 62	— Caractéristiques de performance des extensomètres métalliques à résistance <i>Performance characteristics of metallic resistance strain gauges</i>	1985
R 63	— Tables de mesure du pétrole <i>Petroleum measurement tables</i>	1985
R 64	— Exigences générales pour les machines d'essai des matériaux <i>General requirements for materials testing machines</i>	1985
R 65	— Exigences pour les machines d'essai des matériaux en traction et en compression <i>Requirements for machines for tension and compression testing of materials</i>	1985
R 66	— Instruments mesureurs de longueurs <i>Length measuring instruments</i>	1985
R 67	— Ensembles de mesurage de liquides autres que l'eau équipés de compteurs de volumes. Contrôles métrologiques <i>Measuring assemblies for liquids other than water fitted with volume meters. Metrological controls</i>	1985
R 68	— Méthode d'étalonnage des cellules de conductivité <i>Calibration method for conductivity cells</i>	1985
R 69	— Viscosimètres à capillaire, en verre, pour la mesure de la viscosité cinématique <i>Glass capillary viscometers for the measurement of kinematic viscosity</i>	1985
R 70	— Détermination des erreurs de base et d'hystérésis des analyseurs de gaz <i>Determination of intrinsic and hysteresis errors of gas analysers</i>	1985
R 71	— Réservoirs de stockage fixes. Prescriptions générales <i>Fixed storage tanks. General requirements</i>	1985
R 72	— Compteurs d'eau destinés au mesurage de l'eau chaude <i>Hot water meters</i>	1985
R 73	— Prescriptions pour les gaz purs CO, CO <sub>2</sub> , CH <sub>4</sub> , H <sub>2</sub> , O <sub>2</sub> , N <sub>2</sub> et Ar destinés à la préparation des mélanges de gaz de référence <i>Requirements concerning pure gases, CO, CO<sub>2</sub>, CH<sub>4</sub>, H<sub>2</sub>, O<sub>2</sub>, N<sub>2</sub> and Ar intended for the preparation of reference gas mixtures</i>	1985
R 74	— Instruments de pesage électroniques <i>Electronic weighing instruments</i>	en révision <i>being revised</i>
R 75	— Compteurs d'énergie thermique <i>Heat meters</i>	1988

R 76	— Instruments de pesage à fonctionnement non automatique <i>Nonautomatic weighing instruments</i>	
	Partie 1 : Exigences métrologiques et techniques - Essais <i>Part 1 : Metrological and technical requirements - Tests</i>	(*)
	Partie 2 : Rapport d'essai de modèle <i>Part 2 : Pattern evaluation report</i>	(*)
R 77	— Ensembles de mesurage de liquides autres que l'eau équipés de compteurs de volumes. Dispositions particulières relatives à certains ensembles <i>Measuring assemblies for liquids other than water fitted with volume meters. Provisions specific to particular assemblies</i>	1989
R 78	— Pipettes Westergren pour la mesure de la vitesse de sédimentation des hématies <i>Westergren tubes for measurement of erythrocyte sedimentation rate</i>	1989
R 79	— Étiquetage des préemballages <i>Information on package labels</i>	1989
R 80	— Camions et wagons-citernes <i>Road and rail tankers</i>	1989
R 81	— Dispositifs et systèmes de mesure de liquides cryogéniques (comprend tables de masse volumique pour argon, hélium, hydrogène, azote et oxygène liquides) <i>Measuring devices and measuring systems for cryogenic liquids (including tables of density for liquid argon, helium, hydrogen, nitrogen and oxygen)</i>	1989
R 82	— Chromatographes en phase gazeuse pour la mesure des pollutions par pesticides et autres substances toxiques <i>Gas chromatographs for measuring pollution from pesticides and other toxic substances</i>	1989
R 83	— Chromatographe en phase gazeuse équipé d'un spectromètre de masse et d'un système de traitement de données pour l'analyse des polluants organiques dans l'eau <i>Gas chromatograph/mass spectrometer/data system for analysis of organic pollutants in water</i>	1990
R 84	— Capteurs à résistance thermométrique de platine, de cuivre ou de nickel (à usages techniques et commerciaux) <i>Resistance-thermometer sensors made of platinum, copper or nickel (for industrial and commercial use)</i>	1989
R 85	— Jaugeurs automatiques pour le mesurage des niveaux de liquide dans les réservoirs de stockage fixes <i>Automatic level gauges for measuring the level of liquid in fixed storage tanks</i>	1989
R 86	— Compteurs à tambour pour alcool et leurs dispositifs complémentaires <i>Drum meters for alcohol and their supplementary devices</i>	1989
R 87	— Contenu net des préemballages <i>Net content in packages</i>	1989
R 88	— Sonomètres intégrateurs-moyenneurs <i>Integrating-averaging sound level meters</i>	1989
R 89	— Electroencéphalographes - Caractéristiques métrologiques - Méthodes et moyens de vérification <i>Electroencephalographs - Metrological characteristics - Methods and equipment for verification</i>	1990
R 90	— Electrocardiographes - Caractéristiques métrologiques - Méthodes et moyens de vérification <i>Electrocardiographs - Metrological characteristics - Methods and equipment for verification</i>	1990

R 91	— Cinémomètres radar pour la mesure de la vitesse des véhicules <i>Radar equipment for the measurement of the speed of vehicles</i>	1990
R 92	— Humidimètres pour le bois - Méthodes et moyens de vérification: exigences générales <i>Wood-moisture meters - Verification methods and equipment: general provisions</i>	1990
R 93	— Frontofocomètres <i>Focimeters</i>	1990
R 95	— Bateaux-citernes - Prescriptions générales <i>Ships' tanks - General requirements</i>	1990
R 96	— Bouteilles récipients-mesures <i>Measuring container bottles</i>	1990
R 97	— Baromètres <i>Barometers</i>	1990
R 98	— Mesures matérialisées de longueur à traits de haute précision <i>High-precision line measures of length</i>	1991
R 99	— Instruments de mesure des gaz d'échappement des véhicules <i>Instruments for measuring vehicle exhaust emissions</i>	1991
R 100	— Spectromètres à absorption atomique pour la mesure des polluants métalliques dans l'eau <i>Atomic absorption spectrometers for measuring metal pollutants in water</i>	1991
R 101	— Manomètres, vacuomètres et manovacuumètres indicateurs et enregistreurs <i>Indicating and recording pressure gauges, vacuum gauges and pressure-vacuum gauges</i>	1991
R 102	— Calibreurs acoustiques <i>Sound calibrators</i>	(*)
R 103	— Appareillage de mesure pour la réponse des individus aux vibrations <i>Measuring instrumentation for human response to vibration</i>	(*)
R 104	— Audiomètres à son pur <i>Pure-tone audiometers</i>	(*)

**DOCUMENTS INTERNATIONAUX**  
**INTERNATIONAL DOCUMENTS**

D 1	— Loi de métrologie <i>Law on metrology</i>	1975
D 2	— Unités de mesure légales <i>Legal units of measurement</i>	1978
D 3	— Qualification légale des instruments de mesurage <i>Legal qualification of measuring instruments</i>	1979
D 4	— Conditions d'installation et de stockage des compteurs d'eau froide <i>Installation and storage conditions for cold water meters</i>	1981

D 5	— Principes pour l'établissement des schémas de hiérarchie des instruments de mesure <i>Principles for the establishment of hierarchy schemes for measuring instruments</i>	1982
D 6	— Documentation pour les étalons et les dispositifs d'étalonnage <i>Documentation for measurement standards and calibration devices</i>	1983
D 7	— Évaluation des étalons de débitmétrie et des dispositifs utilisés pour l'essai des compteurs d'eau <i>The evaluation of flow standards and facilities used for testing water meters</i>	1984
D 8	— Principes concernant le choix, la reconnaissance officielle, l'utilisation et la conservation des étalons <i>Principles concerning choice, official recognition, use and conservation of measurement standards</i>	1984
D 9	— Principes de la surveillance métrologique <i>Principles of metrological supervision</i>	1984
D 10	— Conseils pour la détermination des intervalles de réétalonnage des équipements de mesure utilisés dans les laboratoires d'essais <i>Guidelines for the determination of recalibration intervals of measuring equipment used in testing laboratories</i>	1984
D 11	— Exigences générales pour les instruments de mesure électroniques <i>General requirements for electronic measuring instruments</i>	en révision <i>being revised</i>
D 12	— Domaines d'utilisation des instruments de mesure assujettis à la vérification <i>Fields of use of measuring instruments subject to verification</i>	1986
D 13	— Conseils pour les arrangements bi- ou multilatéraux de reconnaissance des résultats d'essais, approbations de modèles et vérifications <i>Guidelines for bi- or multilateral arrangements on the recognition of test results, pattern approvals and verifications</i>	1986
D 14	— Formation du personnel en métrologie légale - Qualification - Programmes d'étude <i>Training of legal metrology personnel - Qualification - Training programmes</i>	1989
D 15	— Principes du choix des caractéristiques pour l'examen des instruments de mesure usuels <i>Principles of selection of characteristics for the examination of measuring instruments</i>	1986
D 16	— Principes d'assurance du contrôle métrologique <i>Principles of assurance of metrological control</i>	1986
D 17	— Schéma de hiérarchie des instruments de mesure de la viscosité des liquides <i>Hierarchy scheme for instruments measuring the viscosity of liquids</i>	1987
D 18	— Principes généraux d'utilisation des matériaux de référence certifiés dans les mesurages <i>General principles of the use of certified reference materials in measurements</i>	1987
D 19	— Essai de modèle et approbation de modèle <i>Pattern evaluation and pattern approval</i>	1988
D 20	— Vérifications primitive et ultérieure des instruments et processus de mesure <i>Initial and subsequent verification of measuring instruments and processes</i>	1988

- D 21 — Laboratoires secondaires d'étalonnage en dosimétrie pour l'étalonnage des dosimètres utilisés en radiothérapie 1990  
*Secondary standard dosimetry laboratories for the calibration of dosimeters used in radiotherapy*
- D 22 — Guide sur les instruments portatifs pour l'évaluation des polluants contenus dans l'air en provenance des sites de décharge de déchets dangereux 1991  
*Guide to portable instruments for assessing airborne pollutants arising from hazardous wastes*
- D 23 — Principes du contrôle métrologique des dispositifs utilisés pour les vérifications (\*)  
*Principles for the metrological control of devices used for verification*

(\*) Publication en cours d'impression/*Publication being printed.*

Note — Ces publications peuvent être acquises au / *These publications may be purchased from Bureau International de Métrologie Légale, 11, rue Turgot, 75009 PARIS.*



# ORGANISATION INTERNATIONALE DE MÉTROLOGIE LÉGALE

## ÉTATS MEMBRES

ALGÉRIE	INDONÉSIE
ALLEMAGNE	IRLANDE
ARABIE SAOUDITE	ISRAËL
AUSTRALIE	ITALIE
AUTRICHE	JAPON
BELGIQUE	KENYA
BRÉSIL	LIBAN
BULGARIE	MAROC
CAMEROUN	MONACO
CANADA	NORVÈGE
RÉP. POP. DE CHINE	PAKISTAN
CHYPRE	PAYS-BAS
RÉP. DE CORÉE	POLOGNE
RÉP. POP. DÉM. DE CORÉE	PORTUGAL
CUBA	ROUMANIE
DANEMARK	ROYAUME-UNI DE GRANDE-BRETAGNE ET D'IRLANDE DU NORD
ÉGYPTE	SRI LANKA
ESPAGNE	SUÈDE
ÉTATS-UNIS D'AMÉRIQUE	SUISSE
ÉTHIOPIE	TANZANIE
FINLANDE	TCHÉCOSLOVAQUIE
FRANCE	TUNISIE
GRÈCE	U.R.S.S.
HONGRIE	YOUgoslavie
INDE	

## MEMBRES CORRESPONDANTS

Albanie - Bahrein - Bangladesh - Barbade - Botswana - Burkina Faso - Colombie - Costa Rica - Équateur - Fidji - Ghana - Hong Kong - Irak - Islande - Jordanie - Koweït - Libye - Luxembourg - Malaisie - Mali - Maurice - Mexique - Népal - Nouvelle-Zélande - Oman - Panama - Pérou - Philippines - Sénégal - Seychelles - Syrie - Trinité et Tobago - Turquie - Venezuela

**MEMBRES**  
**du**  
**COMITÉ INTERNATIONAL de MÉTROLOGIE LÉGALE**

**ALGÉRIE**

Membre à désigner par son Gouvernement  
Correspondance à adresser à  
Office National de Métrologie Légale  
1, rue Kaddour Rahim Hussein Dey  
ALGER

**ALLEMAGNE**

Mr M. KOCHSIEK  
Directeur  
Physikalisch-Technische Bundesanstalt  
Bundesallee 100 - Postfach 3345  
3300 BRAUNSCHWEIG  
TP 49-531-592 80 10      FAX 49-531-592 40 06  
TX 9-52 822 PTB d  
TG Bundesphysik Braunschweig

**ARABIE SAOUDITE**

Mr KHALED Y. AL-KHALAF  
Director General  
Saudi Arabian Standards Organization  
P.O. Box 3437  
11471 RIYADH  
TP 966-1-479 33 32      FAX 966-1-479 30 63  
TX 40 16 10 saso sj  
TG giasy

**AUSTRALIE**

Mr J. BIRCH  
Executive Director  
National Standards Commission  
P.O. Box 282  
NORTH RYDE, N.S.W. 2113  
TP 61-2-888 39 22      FAX 61-2-888 30 33  
TX AA 23144

**AUTRICHE**

Mr R. GALLE  
Director of the Metrology Service  
Gruppe Eichwesen  
Bundesamt für Eich- und Vermessungswesen  
Postfach 20  
Arltgasse 35  
A-1163 WIEN  
TP 43-222-49 11 01      FAX 43-222-49 20 875  
TX 115 468 bevwn

**BELGIQUE**

Mr H. VOORHOF  
Inspecteur Général  
Inspection Générale de la Métrologie  
24-26, rue J.A. De Mot  
B-1040 BRUXELLES  
TP 32-2-233 61 11      FAX 32-2-230 83 00  
TX 20 627 COM HAN

**BRÉSIL**

Mr C.L. FRÓES RAEDER  
Président, INMETRO  
Av. Rio Branco 311, 8° Andar-Centro  
20060 RIO DE JANEIRO  
TP 55-21-262 6231      FAX 55-21-220 0477  
TX 30672 IMNQ BR

**BULGARIE**

Mr V. GAVRAILOV  
Vice-Président  
Comité de normalisation, certification et métrologie  
21, rue du 6 Septembre  
SOFIA 1000  
TP 359-2-8591      FAX 359-2-801402  
TX 22 570 DKS BG

**CAMEROUN**

Mr S. NOUMSI  
Sous-Directeur des Poids et Mesures  
Direction des Prix, Poids et Mesures  
Ministère du Développement Industriel et Commercial  
BP 501  
YAOUNDÉ  
TP 237-22 31 16 et 237-23 26 17  
TX 82-68 à Yaoundé

**CANADA**

Mr R.G. KNAPP  
Director, Legal Metrology Branch  
Consumer and Corporate Affairs  
207, rue Queen  
OTTAWA, Ontario K1A 0C9  
TP 1-613-952 0655      FAX 1-613-952 1736  
TX 053 3694

**RÉPUBLIQUE POPULAIRE DE CHINE**

Mr BAI JINGZHONG  
Deputy Director General  
State Bureau of Technical Supervision  
P.O. Box 2112  
BEIJING 100009  
TP 86-1-44 43 04      FAX 86-1-4011016  
TX 210209 SBTS CN  
TG 1918 Beijing



**CHYPRE**

Mr G. TSIARTZAZIS  
Controller of Weights and Measures  
Ministry of Commerce and Industry  
NICOSIA  
TP 357-2-40 34 41 FAX 357-2-36 61 20  
TX 2283 MIN COMIND  
TG Mincommind Nicosia

**RÉPUBLIQUE DE CORÉE**

Mr Byung-Ju LIM  
Director of Metrology Division  
Bureau of Standards  
Industrial Advancement Administration  
2, Chungang-dong  
KWACHON-CITY, Kyonggi-Do 427-010  
TP 82-2-503 79 28 FAX 82-2-503 79 41  
TX 28456 FINCEN K

**RÉPUBLIQUE POP. DÉM. DE CORÉE**

Mr DJEUNG KI TCHEUL  
Directeur de l'Institut Central de Qualité  
et de Métrologie auprès du Comité National  
de la Science et de la Technologie  
Arrondissement de Sadong  
PYONGYANG  
TG standard

**CUBA**

Membre à désigner par son Gouvernement  
Correspondance à adresser à  
Mr J. Acosta Alemany  
Comite Estatal de Normalizacion  
Egido 610 e/Gloria and Apodaca  
HABANA Vieja  
TP 53-7-62-1503 or 61-2068 FAX 53-7-62 76 57  
TX 512245 CEN CU

**DANEMARK**

Mr Ove E. PETERSEN  
Senior Executive Engineer  
Division of Metrology  
National Agency of Industry and Trade  
Tagensvej 135  
DK-2200 COPENHAGEN N  
TP 45-31-85 10 66 FAX 45-31-81 70 68  
TX 15768 INDTRA DK

**ÉGYPTE**

Mr M. HILAL  
Président  
Egyptian Organization for Standardization  
and Quality Control  
2 Latin America Street, Garden City  
CAIRO  
TP 20-2-354 97 20 FAX 20-2-355 78 41  
TX 93 296 EOS UN  
TG TAWHID

**ESPAGNE**

Membre à désigner par son Gouvernement  
Correspondance à adresser à  
Centro Espanol de Metrologia  
c/ del alfar 2  
28760 TRES CANTOS (Madrid)  
TP 34-1-803 33 03 FAX 34-1-803 11 78  
TX 47254 CEME E

**ÉTATS-UNIS D'AMÉRIQUE**

Mr S.E. CHAPPELL  
Chief, Standards Management Program  
Office of Standards Services  
National Institute of Standards and Technology  
Admin. 101, A625  
GAITHERSBURG, Maryland 20899  
TP 1-301-975 40 24 FAX 1-301-963 28 71  
TX 197674 NBS UT

**ÉTHIOPIE**

Mr Yohannes AFEWORK  
Head of Technical Service  
Ethiopian Authority for Standardization  
P.O. Box 2310  
ADDIS ABABA  
TP 251-1-15 04 00 et 15 04 25  
TX 21725 ETHSA ET  
TG ETHIOSTAN

**FINLANDE**

Madame U. LÄHTEENMÄKI  
Director  
Centre for Metrology and Accreditation  
PL 239 (Lönnrotinkatu 37)  
SF 00181 HELSINKI  
TP 358-0-61 671 FAX 358-0-6167 467  
TX 121394 tltx-SF ATTN Mittakes Hki

**FRANCE**

Mr J. HUGOUNET  
Sous-Directeur de la Métrologie  
Ministère de l'Industrie et du Commerce extérieur  
22, rue Monge  
75005 PARIS  
TP 33-1-46 34 49 61 FAX 33-1-46 34 49 62

**GRÈCE**

Mr A. DESIS  
Technical Officer  
Directorate of Weights and Measures  
Ministry of Commerce  
Canning Sq.  
10181 ATHENS  
TP 30-1-36 14 168 FAX 30-1-364 26 42  
TX 21 67 35 DRAG GR et 21 52 82 YPEM GR

**HONGRIE**

Mr D. BELEDI  
Président  
Országos Mérésügyi Hivatal  
P.O. Box 19  
H-1531 BUDAPEST  
TP 36-1-1567 722 FAX 36-1-1550 598  
TX 22-4856 OMH  
TG HUNGMETER Budapest

**INDE**

Mr S. HAQUE  
Director  
Weights & Measures  
Ministry of Food and Civil Supplies  
Weights and Measures Unit  
12-A, Jam Nagar House  
NEW DELHI 110 011  
TP 91-11-38 53 44  
TX 31 61962 COOP IN  
TG POORTISAHAKAR

**INDONÉSIE**

Mr G.M. PUTERA  
Director of Metrology  
Directorate General of Domestic Trade  
Departemen Perdagangan  
Jalan Pasteur 27  
40171 BANDUNG  
TP 62-22-50 597 et 50 695  
TX 28 176 DITMET BD

**IRLANDE**

Mr J. LOWE  
Assistant Secretary  
Department of Industry and Commerce  
Frederick Building, Setanta Centre,  
South Frederick Street,  
DUBLIN 2  
TP 353-1-61 44 44                      FAX 353-1-67 95 710  
TX 93478  
TG TRADCOM Dublin

**ISRAËL**

Mr. A. RONEN  
Controller of Weights, Measures and Standards  
Ministry of Industry and Trade  
P.O.B. 299  
JERUSALEM 91002  
TP 972-2-27 241

**ITALIE**

Mr C. AMODEO  
Capo dell'Ufficio Centrale Metrico  
Via Antonio Bosio, 15  
00161 ROMA  
TP 39-6-348 78 34

**JAPON**

Mr S. HATTORI  
Director General  
National Research Laboratory of Metrology  
1-4, Umezono 1-Chome, Tsukuba  
IBARAKI 305  
TP 81-298-54 41 49                      FAX 81-298-54 41 35  
TX 03652570 AIST  
TG KEIRYOKEN TSUCHIURA

**KENYA**

Mr P.A. AYATA  
Director of Weights and Measures  
Weights and Measures Department  
Ministry of Commerce  
P.O. Box 41071  
NAIROBI  
TP 254-2-50 46 64/5  
TG ASSIZERS, Nairobi

**LIBAN**

Membre à désigner par son Gouvernement  
Correspondance à adresser à  
Service des Poids et Mesures  
Ministère de l'Économie et du Commerce  
Rue Al-Sourati, imm. Assaf  
RAS-BEYROUTH  
TP — 34 40 60

**MAROC**

Mr M. BENKIRANE  
Chef de la Division de la Métrologie Légale  
Direction de l'Industrie  
5, rue Errich, Immeuble A, Quartier Tour Hassan  
RABAT.  
TP 212-7-72 45 65  
TX 31816 M

**MONACO**

Mr A. VEGLIA  
Ingénieur au Centre Scientifique de Monaco  
16, Boulevard de Suisse  
MC 98000 MONTE CARLO  
TP 33-93-30 33 71

**NORVÈGE**

Mr K. BIRKELAND  
Directeur Général  
Service National de Métrologie  
Postbox 6832 St. Olavs Plass  
0130 OSLO 1  
TP 47-2-20 02 26                      FAX 47-2-20 77 72

**PAKISTAN**

Mr M. ASAD HASAN  
Director  
Pakistan Standards Institution  
39-Garden Road, Saddar  
KARACHI-74400  
TP 92-21-772 95 27  
TG PEYASAI

**PAYS-BAS**

Mr J.A.J. BASTEN  
Directeur, IJkwezen bv  
Nederlands Meetinstituut nv  
Postbus 654  
2600 AR DELFT  
TP 31-78 33 23 00                      FAX 31-15-61 29 71  
TX 38 373 IJKWZ NL

**POLOGNE**

Mr Z. REFEROWSKI  
Vice-Président  
Polski Komitet Normalizacji, Miar i Jakosci  
ul. Elektoralna 2  
00-139 WARSZAWA  
TP 48-22-20 54 34                      FAX 48-22-20 83 78  
TX 813 642 PKN  
TG PEKANIM

**PORTUGAL**

Mr J.N. CARTAXO REIS  
Service de la Métrologie  
Instituto Português da Qualidade  
Rua Prof. Reinaldo dos Santos  
Lote 1378  
1500 LISBOA  
TP 351-1-78 61 58                      FAX 351-1-78 19 80  
TX 65744 METROQ P

**ROUMANIE**

Mr D. STOICHITOIU  
Directeur de la Métrologie d'État  
Commission Nationale de Normalisation,  
Métrologie et Qualité  
21, Boulevard Nicolae Balcescu  
BUCAREST 1  
TP 40-0-13 16 05                      FAX 40-0-14 94 37  
TX 011 355 IGS R

**ROYAUME-UNI**

Mr S. BENNETT  
 Chief Executive  
 National Weights and Measures Laboratory  
 Stanton Avenue  
 TEDDINGTON, Middlesex TW 11 OJZ  
 TP 44-81-943 72 72 FAX 44-81-943 72 70  
 TX 9312131043 (WM G)

**SRI LANKA**

Mr H.L.R.W. MADANAYAKE  
 Deputy Commissioner of Internal Trade  
 Measurement Standards and Services Division  
 Department of Internal Trade  
 101, Park Road  
 COLOMBO 5  
 TP 94-1-83 261  
 TX 21908 COMECE CF

**SUÈDE**

Mr R. OHLON  
 Ingénieur en Chef  
 Statens Provningsanstalt  
 P.O. BOX 857  
 S-501 15 BORÅS  
 TP 46-33-16 50 00 FAX 46-33-13 55 02  
 TX 36252 TESTING S

**SUISSE**

Mr O. PILLER  
 Directeur  
 Office Fédéral de Métrologie  
 Lindenweg 50  
 CH- 3084 WABERN  
 TP 41-31-59 61 11 FAX 41-31-59 62 10  
 TG OFMET

**TANZANIE**

Mr A.H.M. TUKAI  
 Commissioner for Weights and Measures  
 Weights and Measures Bureau  
 Ministry of Industries and Trade  
 P.O. Box 313  
 DAR ES SALAAM  
 TP 64046/64797/64808  
 TX 41 689 INDIS

**TCHÉCOSLOVAQUIE**

Mr A. KURUC  
 Directeur du Service  
 d'Inspection d'État pour la Métrologie  
 Státní metrologický inspektorát  
 Okružní 92  
 638 00 BRNO - LESNÁ  
 TP 42-5-528 755 FAX 42-5-529 149

**TUNISIE**

Mr Ali BEN GAID  
 Président Directeur Général  
 Institut National de la Normalisation  
 et de la Propriété Industrielle  
 Boîte Postale 23  
 1012 TUNIS BELVEDERE  
 TP 216-1-785 922 FAX 216-1-781 563  
 TX 13 602 INORPI

**U.R.S.S.**

Mr V.I. PUSTOVOIT  
 Vice-Président  
 Gosstandart  
 Leninsky Prospect 9  
 117049 MOSCOU  
 TP 7-095-236 40 44  
 TX 411 378 GOST  
 TG Moskva-Standart

**YOUGOSLAVIE**

Mr Z.M. MARKOVIC  
 Head of International Cooperation  
 Federal Bureau of Measures and Precious  
 Metals  
 Mike Alasa 14  
 11000 BEOGRAD  
 TP 38-11-18 37 36 FAX 38-11-620 134  
 TX 11 020 YUZMBG

TP = téléphone FAX = télécopie (téléfax)

Les numéros sont en général indiqués pour le régime automatique international à l'exception des numéros qui sont précédés d'un trait.

*The call numbers are generally indicated for international automatic dialling except where the local number is preceded by a dash.*

TG = télégramme TX = télex

Pour tout télex ou télégramme, il est nécessaire d'indiquer le nom de la personne et sa qualité.

*For all telex or telegrams it is necessary to indicate name of person and occupation.*

## **PRÉSIDENCE**

Président ..... K. BIRKELAND, Norvège  
Vice-Président ..... S.E. CHAPPELL, U.S.A.  
Vice-Président ..... M. KOCHSIEK, Allemagne

## **CONSEIL DE LA PRÉSIDENCE**

K. BIRKELAND, Norvège, Président  
S.E. CHAPPELL, U.S.A., V/Président  
M. KOCHSIEK, Allemagne, V/Président  
J. BIRCH, Australie  
R.G. KNAPP, Canada  
BAI JINGZHONG, Rép. Pop. de Chine  
S. BENNETT, Royaume-Uni  
V.I. PUSTOVOIT, U.R.S.S.  
Le Directeur du Bureau International de Métrologie Légale

## **BUREAU INTERNATIONAL DE MÉTROLOGIE LÉGALE**

Directeur	B. ATHANÉ
Adjoint au Directeur	S.A. THULIN
Adjoint au Directeur	A. VICHENKOV
Ingénieur Consultant	W.H. EMERSON
Ingénieur	E. WEBER
Administrateur	Ph. LECLERCQ

## **MEMBRES D'HONNEUR**

V. ERMAKOV, U.R.S.S. – Vice-Président du Comité  
A.J. van MALE, Pays-Bas – Président du Comité  
A. PERLSTAIN, Suisse – Membre du Conseil de la Présidence  
W. MUEHE, Allemagne – Vice-Président du Comité  
H.W. LIERS, Allemagne – Membre du Conseil de la Présidence

## ADRESSES DES SERVICES DES MEMBRES CORRESPONDANTS

### ALBANIE

The Director  
Drejtoria e Standardeve dhe e Mjeteve  
Matëse (DSMA)  
në Komisionin e Planit të Shtetit  
TIRANA

### BAHREIN

The Responsible of Metrology  
Standards and Metrology Section  
Ministry of Commerce and Agriculture  
P.O. Box 5479  
MANAMA

### BANGLADESH

The Director General  
Bangladesh Standards and Testing Institution  
116-A Tejgaon Industrial Area  
DHAKA 1208

### BARBADE

The Director  
Barbados National Standards Institution  
Culloden Road  
St. Michael  
BARBADOS W.I.

### BOTSWANA

The Permanent Secretary  
Division of Weights and Measures  
Department of Commerce and Consumer Affairs  
Private Bag 48  
GABORONE

### BURKINA FASO

Direction Générale des Prix  
Ministère du Commerce  
et de l'Approvisionnement du Peuple  
BP 19  
OUAGADOUGOU

### COLOMBIE

Superintendencia de Industria y Comercio  
Centro de Control de Calidad y Metrologia  
Cra. 37 No 52-95, 4° piso  
BOGOTA D.E.

### COSTA RICA

Oficina Nacional de Normas y Unidades  
de Medida  
Ministerio de Economía y Comercio  
Apartado 10 216  
SAN JOSE

### ÉQUATEUR

The Director General  
Instituto Ecuatoriano de Normalizacion  
Calle Baquerizo Moreno No 454  
entre 6 de Diciembre y Almagro  
Casilla No 3999  
QUITO

### FIDJI

The Chief Inspector of Weights and Measures  
Ministry of Economic Development, Planning  
and Tourism  
Government Buildings  
P.O. Box 2118  
SUVA

### GHANA

Ghana Standards Board  
Kwame Nkrumah Conference Centre  
(Tower Block - 2nd Bay, 3rd Floor)  
P.O. Box M-245  
ACCRA

### HONG KONG

Commissioner of Customs and Excise  
(Attn. Trading Standards Investigation Bureau)  
Tokwawan Market & Government Offices  
165, Ma Tau Wei Road  
11/F., Kowloon  
HONG KONG

### IRAK

Planning Board  
Central Organization for Standardization  
and Quality Control  
P.O.B. 13032  
Al Jadiria  
BAGHDAD

### ISLANDE

The Director  
Icelandic Bureau of Legal Metrology  
Löggildingarstofan  
Sidumuli 13  
P.O. Box 8114  
128 REYKJAVIK

### JORDANIE

Directorate of Standards  
Ministry of Industry and Trade  
P.O. Box 2019  
AMMAN

### KOWEIT

The Under Secretary  
Ministry of Commerce and Industry  
Department of Standards and Metrology  
Post Box No 2944  
KUWAIT

### LIBYE

The Director General  
National Centre for Standardization  
and Metrology (N.C.S.M.)  
P.O. Box 5178  
TRIPOLI

### LUXEMBOURG

Le Préposé du Service de Métrologie  
Administration des Contributions  
Rue des Scillas  
2529 HOWALD

**MALAISIE**

The Director of Standards  
Standards and Industrial Research Institute of Malaysia  
P.O. Box 7035  
40911 Shah Alam  
SELANGOR DARUL EHSAN

**MALI**

Le Directeur Général des Affaires Économiques  
(Service des Poids et Mesures)  
BP 201  
BAMAKO

**MAURICE**

The Permanent Secretary  
Ministry of Trade and Shipping  
(Division of Weights and Measures)  
New Government Centre  
PORT LOUIS

**MEXIQUE**

Dirección General de Normas  
Secretaría de Comercio y Fomento Industrial  
Sistema Nacional de Calibración  
Ave. Puente de Tecamachalco no. 6 - Planta Baja  
Lomas de Tecamachalco, Sección Fuentes  
53950 NAUCALPAN DE JUAREZ

**NÉPAL**

The Chief Inspector  
Nepal Bureau of Standards and Metrology  
P.B. 985  
Sundhara  
KATHMANDU

**NOUVELLE-ZÉLANDE**

The Manager  
Trade Measurement Unit  
Ministry of Consumer Affairs  
P.O. Box 1473  
WELLINGTON

**OMAN**

The Director General  
for Specifications and Measurements  
Ministry of Commerce and Industry  
P.O. Box 550  
MUSCAT

**PANAMA**

Le Directeur  
Comision Panamena de Normas Industriales  
y Tecnicas  
Ministerio de Comercio e Industrias  
Apartado 9658  
PANAMA 4

**PÉROU**

The Director General  
ITINTEC Instituto de Investigacion Tecnologica  
Industrial y de Normas Tecnicas  
Av. Guardia Civil No. 400  
LIMA 41

**PHILIPPINES**

Bureau of Product Standards  
Department of Trade and Industry  
3rd floor DTI Building  
361 Sen. Gil J. Puyat Avenue  
Makati, Metro Manila  
PHILIPPINES 3117

**SÉNÉGAL**

Le Directeur  
Institut Sénégalais de Normalisation  
Ministère du Plan et de la Coopération  
DAKAR

**SEYCHELLES**

The Director  
Seychelles Bureau of Standards  
P.O. Box 648  
VICTORIA

**SYRIE**

The General Director  
The Syrian Arab Organization  
for Standardization and Metrology  
P.O. Box 11836  
DAMASCUS

**TRINITÉ ET TOBAGO**

The Director  
Trinidad and Tobago Bureau of Standards  
P.O. Box 467  
PORT OF SPAIN

**TURQUIE**

Le Directeur Général  
Service du Contrôle de la Qualité et des Mesures  
Sanayi ve Ticaret Bakanligi  
Ölçüler ve Kalite Kontrol Genel  
Müdürlüğü  
ANKARA

**VENEZUELA**

Le Directeur  
Dirección General de Tecnología  
Servicio Nacional de Metrología  
Ministerio de Fomento  
Av. Javier Ustariz, Edif. Parque Residencial  
Urb. San Bernardino  
CARACAS