

Bulletin OIML n° 118

Mars 1990

ISSN 0473-2812

BULLETIN

DE

L'ORGANISATION

INTERNATIONALE

DE MÉTROLOGIE LÉGALE



BUREAU INTERNATIONAL DE METROLOGIE LEGALE
11, Rue Turgot — 75009 PARIS — France

BULLETIN
de
L'ORGANISATION INTERNATIONALE de MÉTROLOGIE LÉGALE

SOMMAIRE

	Pages
REPUBLIQUE FEDERALE D'ALLEMAGNE — The design of air-conditioning systems for metrology and testing laboratories by W. SCHOLLMEIER	3
REPUBLIQUE POPULAIRE DE CHINE — A method for automatic calibration of belt conveyor scales by SHI FAN and JIN JUN-HUA	20
ROYAUME-UNI — Automatic rail-weighbridges by R. ROBINSON	24
URSS — Gosstandart's experience in designing and equipping metrological and test laboratories by A. VISHENKOV	34
Travaux de l'OIML — Work of OIML 1989-1990	37
INFORMATIONS	
Français	48
English	51
Réunions OIML	54
DOCUMENTATION	
Publications: Liste complète à jour	55
Etats membres de l'Organisation Internationale de Métrologie Légale	62
Membres actuels du Comité International de Métrologie Légale	63
Adresses des Services des Membres Correspondants	68

Abonnement pour 1990 : Europe : 175 F-français
Autres pays : 230 F-français
Chèques postaux : Paris 8 046-24 X
Banque de France : B.P. 140-01 - 75049 Paris Cedex 01
Comptes Courants, Banques Etrangères, Cpte n° 5051-7

BUREAU INTERNATIONAL DE METROLOGIE LEGALE
11, Rue Turgot — 75009 Paris — France
Tél. 33 (1) 48 78 12 82 Le Directeur : Mr B. ATHANÉ
et 42 85 27 11 Télécopie : 33 (1) 42 82 17 27
Télex : SASVP 215463F ATTN OIML

R.F. D'ALLEMAGNE

The DESIGN of AIR-CONDITIONING SYSTEMS for METROLOGY and TESTING LABORATORIES *

by **W. SCHOLLMEIER**

Physikalisch-Technische Bundesanstalt, Braunschweig

SUMMARY — The design of air-conditioning systems is influenced by many items such as

- *the extreme values of ambient climate and environmental conditions*
- *the specifications and requirements according to the kind of work to be performed in the conditioned room*
- *the structure and construction of the building*
- *heat and humidity dissipation by measuring equipment and staff, etc.*

The author analyses the interrelations of these factors and their influence on the running costs by describing first the operating principle of the components of a/c-systems, and discussing the general influence of the external climatic conditions on the design using examples of typical climates.

The requirements on the conditioning for metrology and testing laboratories and the links of mutual influence of the most relevant parameters are explained by use of a diagram.

Finally the possible arrangements of equipment and the means of conditioning a room are considered with respect to advantages and applications.

RESUME — La conception des systèmes d'air conditionné pour les laboratoires de métrologie est gouvernée par des facteurs tels que

- *les valeurs extrêmes des conditions climatiques extérieures*
- *les spécifications et exigences dictées par le type de travail à effectuer dans le local conditionné*
- *la structure et le type de construction du bâtiment*
- *la dissipation de chaleur et d'humidité provoquée par les instruments de mesure ou par la présence du personnel, etc.*

L'auteur analyse les relations de ces facteurs et leur influence sur les coûts de fonctionnement en décrivant d'abord les principes des composants de systèmes d'air conditionné et en traitant l'influence générale des conditions climatiques extérieures sur leur conception en utilisant des exemples de climats typiques.

Les exigences sur le conditionnement d'air pour la métrologie et les essais et les influences mutuelles des paramètres les plus importants sont expliquées à l'aide d'un schéma.

Les mérites des différentes possibilités d'agencement des équipements et les moyens de conditionner un local sont comparés quant à leurs avantages et applications.

(*) Presented at the OIML Seminar on Planning and Equipping Metrology and Testing Laboratories, Paris 25-26 September 1989.

Preliminary remarks

As the subject of climatization is very complex and the ways of realizing an air-conditioning(a/c)-system are very numerous the intention of this presentation can be only to give some hints and a glance of the aspects to be considered for the design of an air-conditioning system.

First the components and their functions of an a/c-system shall be demonstrated at a schematic example. This example represents in principle an a/c-system as it could be designed for operation in the moderate climate of Europe for measuring rooms without extreme specifications.

1. The principles of operation

Figure 1 shows the basic scheme of a central a/c-system according to the descriptions in [1] and [2].

Ambient air is sucked in through a (coarse) filter F_1 into the mixing chamber M where it mixes with the circulating air before passing through another (fine) filter F_2 . The filter F_1 will be specially required if the a/c-system is located in a dusty environment like in the desert or in adjacent regions with a hot and dry climate. The air then passes through the other components of the system as follows:

- a) The preheater PH will warm up the air if it is too dry and its temperature too low for a sufficient humidification by the humidifier H following behind the adjacent cooler C.
- b) The cooler C serves either for cooling or for dehumidifying by cooling the air below its dew-point temperature. The predominant kind of operation depends on the length of the cooler and on its operating temperature, as a longer construction is used for dehumidification in general.
- c) Inside the humidifier H (deionized) water is sprayed into the air-flow to increase the humidity by the evaporation of water.
As this process consumes heat for the evaporation the preheater PH will generally be operated simultaneously to add the required amounts of heat.
- d) At the end of the conditioning processes the reheater RH regulates the temperature of the air according to the control-signal of the thermostat.

In general the heaters get their heat either

- from circulating warm water or steam originating from central heating systems or
- from a gas-burning system or
- by electrical heating elements.

The cooler can be supplied by

- cold water from a well
- cold (glycolized-) water circulating through the cooling element of a refrigerator-system, or the cooling element of the refrigerator itself is mounted inside the cooler and cools the air directly
- modern Peltier-elements (for low-power applications only).

The humidifier can also use steam for humidifying. In general this steam would be supplied by a central heating system or by a separate electrically heated boiler.

The consecutive feeding ventilator V sucks in the conditioned air and blows it as supply-air through the airducts and the noise-absorber(s) into the measuring room, where the thermostat TS and the hygrostat HS are sensing the temperature and relative humidity of the air. Their output-signals are compared with the rated values. The resulting difference signals control the regulators HR and TR which actuate the valves and/or switches at the corresponding components of the a/c-system: cooler, heater, pumps of the humidifier or of the refrigerating system.

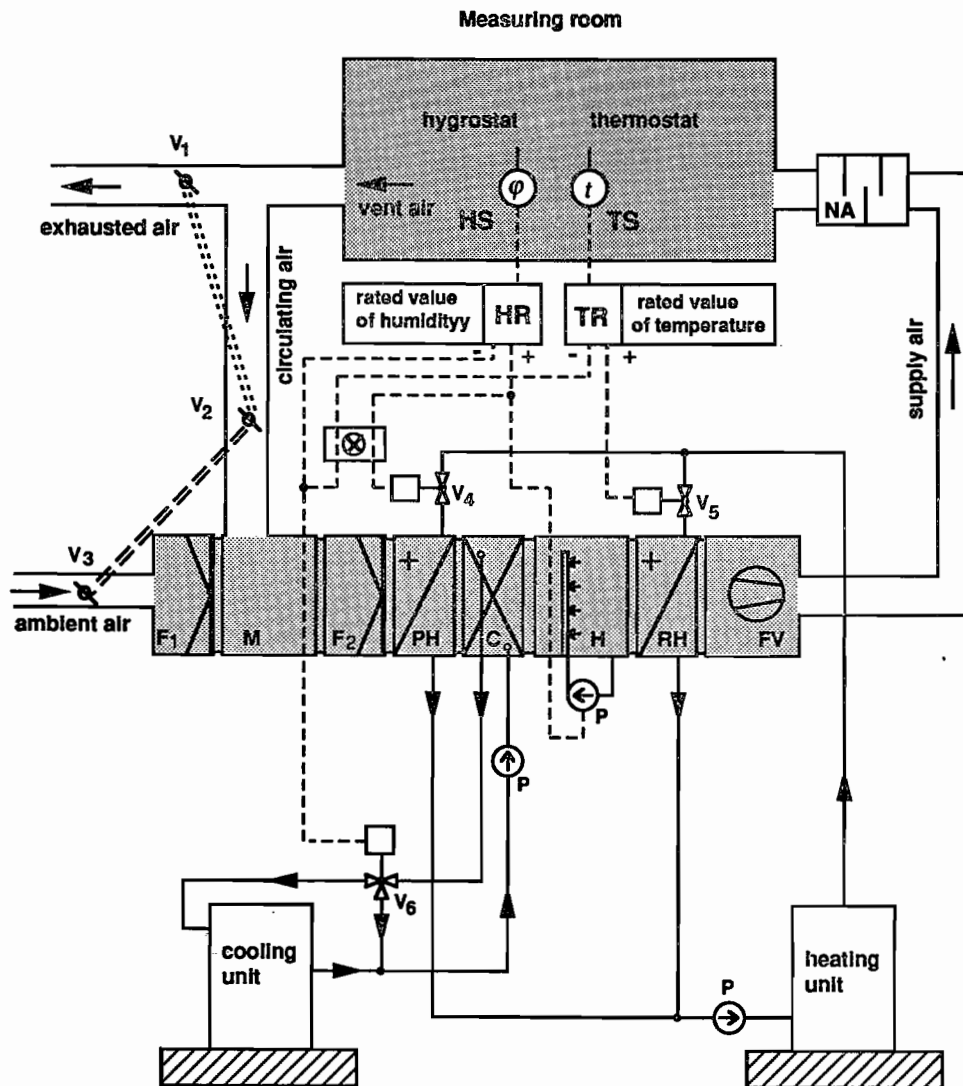

Fig. 1 — Basic scheme of an a/c-system

- | | |
|--|----------------------------|
| V ₁ , V ₂ , V ₃ = throttle valves (flaps) | H = humidifier |
| V ₄ , V ₅ , V ₆ = valves for heating/cooling circuits | RH = reheater |
| F ₁ , F ₂ = filters | FV = feeding ventilator |
| M = mixing chamber | P = pump |
| PH = preheater | NA = noise absorber |
| C = cooler/chiller, dehumidifier | TR = temperature regulator |
| HS = humidity sensor | HR = humidity regulator |
| TS = temperature sensor | |

The main components are controlled according to Table 1. Here one can see that:
the thermostate controls:

- the cooler C only in case of over-temperature (ΔT : +, line 2)
- the reheater RH in case of under-temperature (ΔT : —, line 3)

the hygrostate controls:

- the cooler C only in case of over-humidity (Δ r.h.: +, line 4). In this case the humid air will be cooled below the dewpoint-temperature which in turn will be sensed by thermostate some time later causing the reheater to operate for compensation of the losses of temperature (see also line 3).
- the preheater PH and the humidifier H simultaneously in case of underhumidity (Δ r.h.: —, line 5). In this case the preheater has to supply the heat needed for the evaporation of water in the humidifier H.

TABLE 1 — ASSIGNMENT of OPERATING-STATES to COMBINATIONS of CONDITIONS

Line Nr.	Deviation AV-RV		Operating states of the components of the a/c-system			
	Δ r.h.	ΔT	PH	C	H	RH
1	0	0	0	0	0	0
2	0	+	0	1	0	0
3	0	—	0	0	0	1
4	+	0	0	1	0	0 (× 1)
5	—	0	1	0	1	0
6	+	+	0	1	0	0
7	+	—	0	1	0	1
8	—	+	1 (× 0)	1 (× 0)	1	0
9	—	—	1	0	1	1

AV = actual value
 RV = rated value
 Δ r.h. = deviation of relative humidity
 $AV(r.h.) - RV(r.h.)$
 ΔT = deviation of temperature
 $AV(T) - RV(T)$
 + = Δ r.h. or $\Delta T \geq 0$
 — = Δ r.h. or $\Delta T \leq 0$
 0 = Δ r.h. or $\Delta T \approx 0$

PH = preheater
 C = cooler
 H = humidifier
 RH = reheater
 0 = off, not operating
 1 = on, in operation
 × = "exclusive-or" interlock

In the lines 6 to 9 the operating states of the components are shown for the remaining combinations of Δ r.h. and ΔT . According to line 8 the combination of underhumidity with over-temperature (combination of line 5 and line 2) would cause the preheater PH and cooler C to work simultaneously with almost no effect on the temperature and relative humidity of the air, but with a senseless energy consumption, which could be avoided by an additional interlocking of this particular operating

state as is indicated by the symbol within brackets containing an "x" representing an "exclusive-or"-kind of interlocking.

After being used the air leaves the measuring room as vent air through vents located at another side of the room. Part of it will leave the system as exhausted air through the throttle-valve V_1 into the environment. The remaining air returns to the central conditioning unit, where it enters the mixing-chamber through the throttle valve V_2 . Here it gets mixed with a certain amount of (fresh) ambient air (about 5...20 % of the flow-rate of circulating air, depending on the air-consumption e.g. by workers in the room) which is controlled by the valves V_2 and V_3 .

Often a certain amount of over-pressure in the measuring room is recommendable, which can be controlled by the valves V_1 and V_2 . This over-pressure can avoid the environmental dust to penetrate into the conditioned room.

2. Typical examples of environmental climates

As the European climate is changing between continental climate in case of eastern winds with dry and fairly cold or fairly warm air and the rather maritime climate in case of western winds with humid air at moderate temperatures, the a/c-systems will here, depending on the requirements, generally have to comprise all facilities for heating, cooling, humidifying and dehumidifying like the system already described above.

Other climates in the world may not require an a/c-system with all the components if their extreme conditions almost never exceed one or more of the rated conditions for a particular measuring room.

Four examples of typical climates of the world are shown in Fig. 2:

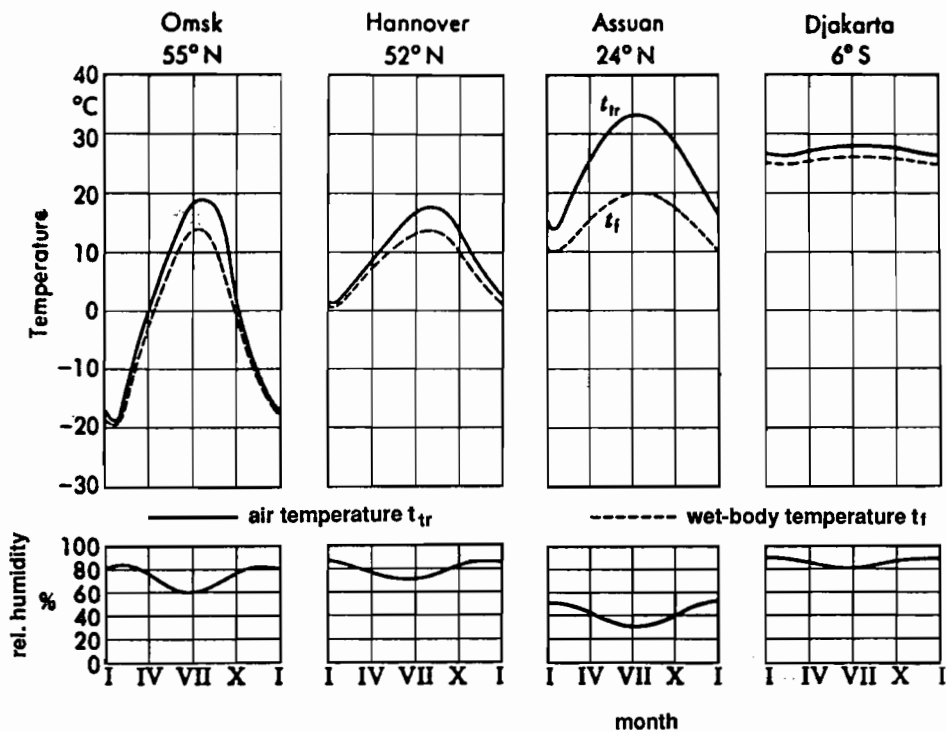

Fig. 2 — Examples of typical climates, from ref. [1]

In the upper diagrams, the solid lines indicate psychrometer dry bulb temperatures and the dotted lines wet bulb temperatures.

- a) A cold climate
(being defined with a minimum of the monthly averaged air temperatures below -15°C) with temperatures between -20°C and $+20^{\circ}\text{C}$ and relative humidities between 80 % and 60 % as it has been observed in Omsk in Siberia.
This extreme fluctuation of temperature is typical of continental climates.
- b) A moderate climate
(being defined by monthly averaged temperatures between -15°C and $+25^{\circ}\text{C}$, typical for north and central Europe and northern states of USA).
The example is indicating temperatures between 0°C and 18°C and relative humidities between about 90 % and 70 % as it has been observed in Hannover, Fed. Rep. of Germany.
- c) A dry climate
(being defined by monthly averaged temperatures above 25°C , typical for north Africa, Arabia and southern states of USA).
This example shows the climate of Assuan, Egypt with temperatures between 15°C and 35°C and with relative humidities between 50 % and 30 %.
- d) A humid-warm climate
(being defined by average temperatures exceeding 20°C and by an average rel. humidity above 80 %, typical for India, central Africa and the Amazonian region).
In this example the maritime climate of Djakarta, Indonesia is represented with an almost constant temperature of about 27°C and also with a constant relative humidity of about 85 %.

3. General influences of ambient climates on the design

For studying the impact of an ambient climate on the design of an a/c-system it should be assumed that this a/c-system shall maintain an air-temperature of 20°C at relative humidities below 60 % to avoid corrosion of ferrous metals inside a measuring room. (Corrosion of ferrous metals starts at about 56 % relative humidity).

It should be noticed that this choice of climatic requirements to be met inside the conditioned room will have at least the same impact on the design as has the ambient climate.

In this case by selecting the relative humidity to be kept below 60 % the necessity of providing a humidifier with a preheater can be omitted for all example climates.

Now considering the climate of Omsk with relative humidities above 60 % during most parts of the year a dehumidifier appears to be necessary. But during the whole year the ambient air requires warming up to achieve the temperature of 20°C before entering the conditioned room. At this heating-process the relative humidity decreases in summer-time from about 60 % to about 55 % and in winter-time from about 85 % to about 5 % ! Thus only a single heater but a fairly powerful one would be required in this a/c-system to meet the above mentioned requirements in the ambient climate of Omsk to maintain the large temperature-difference of about 40 K between ambient temperature and room temperature during winter-time.

In Assuan a cooler will be required to bring down the air-temperature in summer time from about 33°C to the required 20°C . Although the ambient relative humidity with 30 % being well below the required upper limit of 60 % the cooling process will increase the relative humidity above 65 %. Thus the cooler has to be designed as a dehumidifier with lower surface-temperature and larger construction size offering a sufficient interaction length. Additionally some postheating could be required to adjust the temperature of the conditioned air to the required value i.e. 20°C .

In Djakarta the ambient temperature and humidity of the air are fairly constant at about 27 °C and 85 % respectively. Here cooling of the air down to 20 °C will not be sufficient because only a part of the high humidity will condensate inside the cooler and the air will leave the cooler with high relative humidities close to 100 %. A dehumidifier with a surface-temperature below 11 °C (dewpoint-temperature of humid air at 20 °C and 55 % r.h.) will be necessary to get rid of the excess humidity. Afterwards the air has to be heated again to attain the required 20 °C. In this case the cooling-system has to be fairly powerful to extract permanently the required amounts of humidity.

Finally in the climate of Hannover a conditioned room would require a permanent heating during the whole year to maintain the air-temperature of 20 °C according to the climatic characteristics shown in fig. 2. At the heating process the ambient relative humidity will change from about 90 % to about 27 % in winter and from about 70 % to just about 60 %. Now some details become important for the ultimate design of the a/c-system which shall be able to maintain the required conditions even at worst ambient conditions. For this purpose the considered data of averaged temperatures and humidities just representing the general characteristics of different ambient climates are not sufficient, because they do not tell anything about the extremes of ambient conditions under which the a/c-system has to be capable to maintain the required conditions in a measuring room.

Thus for a good design the averages of **extremes** of ambient temperature and humidity have to be evaluated from data being observed in the course of many years to be taken into account at the dimensioning of each component of the a/c-system.

On the other hand the choice of requirements to be maintained by the a/c-system have an equivalent impact on the design like the extremes of ambient climate, because the system has to be designed to meet the extremes of differences between ambient and required conditions.

4. Ambient requirements in measuring and testing rooms

The requirements for climatic conditions inside measuring or testing rooms depend on the kind of work to be performed there, on the accuracy of measurement, calibration or verification, or on the kind of testing. The Table 2 shows a choice of examples from different sources ([3], [4], [5]) but it does not pretend to give a complete picture.

Length measurements require generally a reference-temperature of 20 °C with closest tolerances for the stability and gradients of temperature. But on the contrary they do not demand much as regards tolerances of relative humidity. Just some upper levels of humidity are stipulated for avoiding corrosion of ferrous materials.

The tolerances for temperature are also closer for other calibrations, verifications and measurements, but become wider with decreasing accuracy.

Finally the tolerances for temperature and humidity are the widest ones for testing of equipment. However for the testing of certain materials like textiles, papers, plastics etc. fairly close tolerances for both temperature and humidity are required.

The other reference temperature of 23 °C applies for dimensional metrology in hot countries and is used in general for almost all other fields of metrology.

This wide spectrum of requirements indicate that first the kind of work to be performed in a room should be defined in all details. Then, climatic requirements have to be selected carefully according to applicable standards and also with respect to the reference temperature and humidity, including their permissible tolerances, the stability and gradients. The a/c-system can then be designed basing on the selected metrological requirements and the relevant extreme data of ambient climate.

Table 2 — EXAMPLES of CLIMATIC CONDITIONS for MEASURING and TESTING ROOMS

Reference temperature	Tolerance	Maximum drift	Gradient	Relative humidity	Application			
					Kind	Acc. Class		
20 °C	0.1 K	0.1 K/8 h	≤ 0.05 K/m	≤ 50 %	C	I	dimensional, length [3c]	
	0.3 K (3)			≤ 45 %	C	II	dimensional, length and optical labs [5]	
	1 K			≤ 45 %	C	III	dimensional, length and optical labs [5]	
	23 °C (1)	0.5 K			< 70 %	V		engineering metrology (dim. length) [4]
		1 K		≤ 1 K	< 70 %	V		tape measures [4]
		2 K	0.5 K/h 1 K/d (2)	< 0.5 K/m	40...60 %	M	IV	dimensional length, industrial requirements [3a]
		4 K	1.5 K/h 3 K/d (2)	< 1 K/m	40...60 %	M	V	dimensional length, industrial requirements [3a]
23 °C	0.5 K			< 70 %	V		electrical standards [4]	
	1 K			35...55 %	C	II	temperature, accelerometers, dc, LF, pressure, vacuum [5]	
	1 K			< 70 %	V		electrical energy meters [4]	
	1.5 K			20...55 %	C	III	temperature, accel., dc, LF pressure, vacuum [5]	
	1.5 K			35...55 %	C	II	flow, force, HF, microwave [5]	
	1.5 K			20...55 %	C	III	flow, force, HF, microwave [5]	
	no specifications	0.3 K			< 70 %	V		domestic gas meters [4]
3 K				< 70 %	V		photometry (part of tests) [4]	
20...25 °C				< 70 %	V		thermometry [4]	
18...27 °C		0.5 K/h		< 70 %	V		mass [4]	
18...27 °C				< 70 %	V		heavy weights, large volume [4]	
18...27 °C				< 70 %	T		testing: balances, vibration-tests of equipment [4]	
15...30 °C				< 70 %	T		general testing of mechanical and electrical products [4]	
20 °C	2 K			(65 ± 2) %	MT		special material testing: textiles and polymers [4]	
23 °C	1 K			(50 ± 2) %	MT		special material testing: paper (leather, plastics, rubber) [4]	

(1) for hot countries

(2) during measurement

(3) at area of measurements

Symbols, Kind: C = calibration, V = verification, M = measurement, T = testing of equipment, MT = testing of materials

Symbols, Accuracy Class: I = national laboratory, II, III = commercial and industrial calibration laboratories, IV, V = industrial production control laboratories

5. Particular conditions influencing some details of the design

The most important parameters of a/c-systems for the user are the attainable tolerances, drift and gradients of temperature and sometimes also of humidity.

These parameters are basically influenced by the kind of regulator used for controlling the conditioning components of the a/c-system.

For example a so called "two-point switching regulator" creates regularly a saw-tooth-like going up and going down of the regulated quantity e.g. temperature, moving between two switching points. Here the thermostat is only switching on or off either a cooler, if only heat has to be taken off the room, or a heater if only heat is required to keep the temperature at a certain level.

But even with this simple regulating principle it is possible without great difficulties to meet most of the requirements for testing and metrology laboratories, as long as the saw-tooth-fluctuations can be kept within ± 1 K.

For more stringent requirements one should select continuously operating regulators and controlling elements which perform a continuous transition between completely "off" and completely "on". This could be realized by e.g. pneumatic, electric or electronic or combined technics.

At more stringent requirements the stability of the sensors for temperature and humidity play an increasingly important role. Specially the common sensors of humidity have to be checked and/or regenerated regularly.

Most of the important conditions, parameters and quantities affecting the design of an a/c-system are collected and displayed in Fig. 3, at the left side for humidity and at the right side for temperature.

The arrows indicate which quantity or requirement is linked to external conditions or parameters, and how the quantities and parameters are linked mutually. The use of this diagramme is illustrated by the following examples:

The "extremes of environmental temperatures" result in the "peak environmental temperature". With the "requirements for testing and metrology" the "nominal reference temperature" is determined. The difference between "peak environmental temperature" and "nominal ref. temp." determines the maximum difference of temperature between inside and outside of the room. Under the condition that this difference is positive (outside peak temperature is greater than the reference temperature) it determines the maximum amount of heat entering the room by penetrating through "heat leakages" such as doors, windows, walls and by the portion of "ambient air" being mixed to the circulating air. This "maximum amount of ambient air" is determined by the "maximum amount of working people" in the room.

The heat coming into the room through the "heat-leakages" has to be combined with the "maximum amount of heat generated", which is determined by the "maximum amount of energy dissipation" by lamps and equipment, by "external radiation: sunlight" and by the "maximum amount of working people" again. This sum represents the maximum amount of heat to be subtracted by the cooler and indicates the required minimum capacity of the cooler (including the refrigerator system or cooling unit).

In principle the same considerations can be done for the "maximum amounts of humidity to be added or subtracted" affecting either the humidifier with pre-heater or the dehumidifier.

Similarly the "required stability" and the "maximum fluctuation of generated heat" will determine the "maximum amount of circulating air-flow", as a high air-flow reduces the temperature-fluctuations caused by fluctuating heat sources. The same applies for the fluctuations of humidity and for temperature gradients, which can also be reduced by higher amounts of circulating air-flow. But this air-flow has a strong impact on all components of the a/c-system with respect to the dimensions and cross-sections being open to the air-flow.

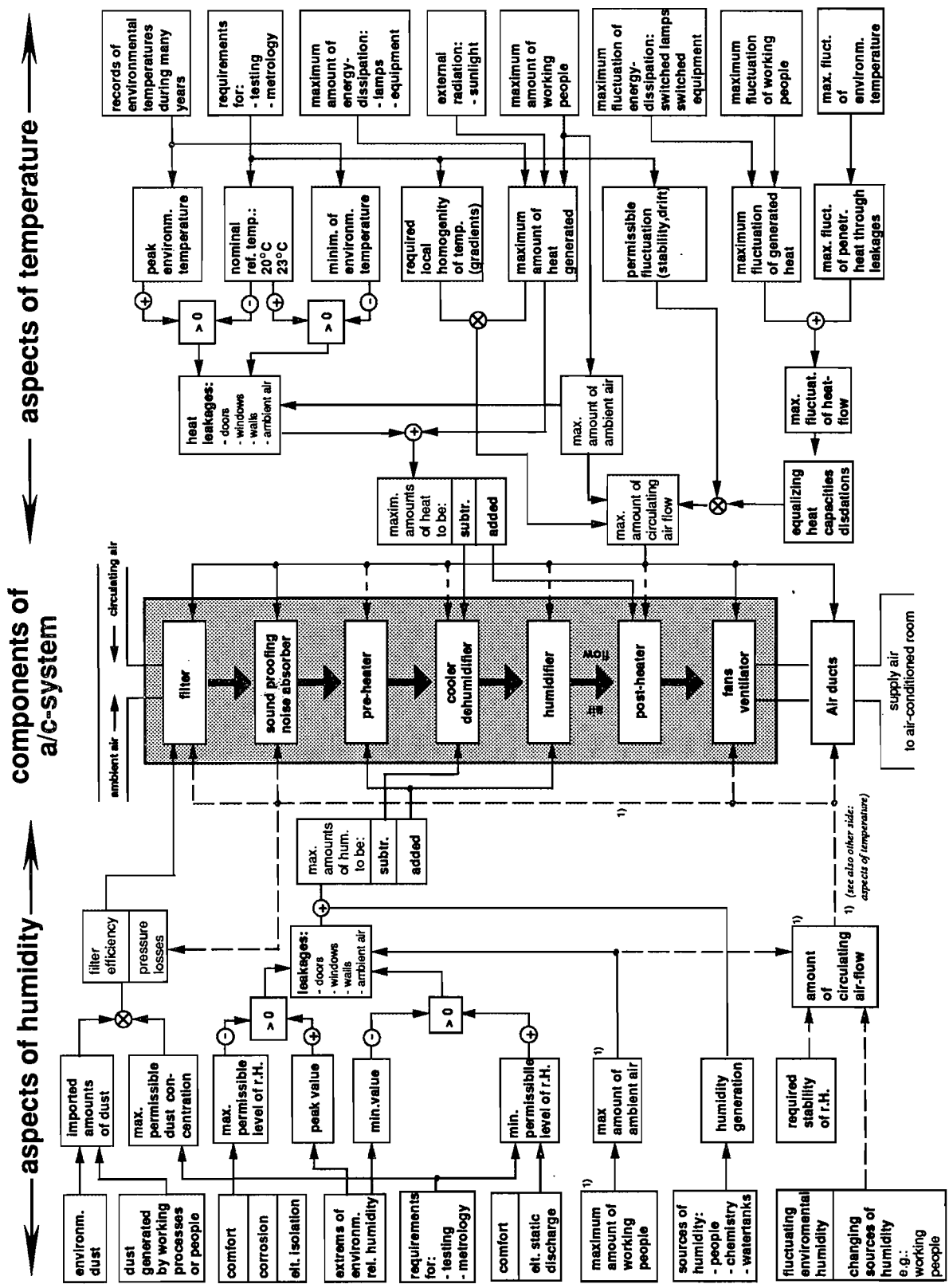

Fig. 3 Conditions, requirements and environmental quantities affecting the design of an air-conditioning system

Finally also the running costs are affected by the amount of air-flow due to the energy-consumption of the ventilators which keep the air circulating.

6. Possibilities for minimizing costs

The most important target in designing an a/c-system should be to keep the running costs as low as possible which can be achieved in general with increased efforts for installing as many suitable passive elements as possible although it may cause an increase of investment costs. But these costs have to be paid only once during the life-time of the equipment !

The simplest and most effective way of saving money in both kinds of costs is to keep the requirements with respect to stability, tolerances and gradients and also the choice of reference temperature in relation to the mean ambient temperature not more stringent than just necessary.

In some cases it is not important to keep a certain value of reference temperature but to have a good stability or sufficiently slow drift of temperature.

In such cases one may locate the measuring room in an environment with a stable temperature or at least with high heat-capacity combined with a good thermal insulation. This can generally be realized below ground level in basements and deep cellars with thick walls, in tunnels, caves or mines. No a/c-system other than for ventilation would then be required. This could save most of the running costs but would perhaps require some extra investment costs for digging and (special) construction works according to the individual and particular conditions.

In all cases where an a/c-system is required one can reduce its running costs by minimizing or maximizing those quantities, conditions or requirements which are affecting the most cost-creating quantities like:

- the (maximum) amounts of heat to be added/subtracted
- the (maximum) amounts of humidity to be added/subtracted
- the (maximum) amount of circulating air-flow.

The items affecting these cost-efficient quantities can be found in fig. 3 by following the arrows in their reversed direction.

The "maximum amount of heat" can thus be reduced by minimizing the heat leakages through doors, walls, windows, by minimizing the "amount of ambient air" and by minimizing the "heat generated" inside the room. The minimizing of the "heat-leakages" can be achieved by maximizing the heat-insulation of the concerned room using:

- double doors,
- double-glass windows and
- thick walls or walls with additional heat insulating layers and/or double walls.

The required amount of ambient air can be reduced if the number of people working in the concerned room can be kept low, which would also help to reduce:

- the fluctuations of temperature at going and coming
- the generation of humidity and its fluctuation
- the development of heat and heat-radiation inside the room.

The generated heat could be reduced further by:

- using the minimum amount of light sources (one lamp just where it is needed only) consisting of fluorescent lamps with high efficiency, if possible
- selecting equipment with low heat dissipation or with additional cooling devices e.g. with connections to external cooling systems (cold water), and

- protecting the room against direct sunlight using:
 - shadowing roofs at the windows
 - externally mounted reflecting venetian blinds and/or
 - selecting rooms located at the less sunny side of the building, if possible without windows.

The maximum amounts of humidity to be added/subtracted can be reduced most easily by selecting the least stringent requirements possibly with minimum differences between the selected maximum/minimum levels and the (average) ambient humidity. Additionally all sources of humidity should be kept as small as possible like the number of working people inside the room and the leakages. This leads to almost the same measures as already discussed concerning the heat insulation.

Finally the amount of circulating air flow could be kept low if the requirements for stability and gradients of temperature and humidity are selected so as to be just sufficient.

On the other hand simple measures could improve the stability and gradients of temperature at that particular location where it is really needed e.g. by putting the sensitive equipment into a suitable thermally insulated container which is screened from heat-radiation and air movement. Thus the need of a high stability or of low temperature gradients in the air inside the entire room can be avoided.

Furthermore all changes of heat-dissipation or heat-penetration decreasing the stability and homogeneity of the air-temperature should be avoided by:

- keeping the equipment and the lamps permanently switched on
- minimizing the coming/going of people in the room
- darkening of the windows
- keeping doors and windows closed
- improving the heat-insulation of the room, or
- selecting a room in stable ambient conditions e.g. in cellars.

7. Arrangements inside the conditioned room

7.1 The location of the sensors

Based on the principle of regulating circuits the controlling components of an a/c-system will deliver either as much of heat or of "cold" as is necessary until the sensor observes a temperature being equal to the rated value of temperature.

As a consequence it is, at steady state condition, only the temperature sensor which is kept correctly at a certain temperature (being, within certain limits, equal to the rated temperature set at the regulator).

In other words even with a best designed and perfectly operating a/c-system the specifications for the conditioning of the air concerning required temperature and humidity including their tolerances and stabilities will be met only in a narrow vicinity surrounding the sensors i.e. the controlled space. This controlled space ends at any source of heat or humidity and at streams of air which have been already influenced by such sources on the up-stream side of the sensors in the air-flow.

For finding the best position of the sensors inside the room two extremes shall be considered now:

Case A) Supposed the sensor is located inside the supply-air duct close to its entrance into the room. Thus correctly conditioned air will be blown into the room.

Downstream of the flow towards the vent-hole the air collects all heat and humidity generated e.g. by people, equipment etc. on its way through the room, thus increasing its temperature and humidity.

Finally the air is leaving the room with higher temperature and humidity than at its entering. This increase of temperature and humidity depends on the flow-rate or speed of the air and on the amounts of heat and humidity collected on its way through the room.

So the genuine air just having passed the sensors will satisfy the specification until it reaches the first influencing source of heat or humidity.

Case B) Supposed now the sensors are located inside the duct of vent-air, so the air passing through the room will collect heat and humidity as described above. Thus the supply-air entering the room has to have a temperature and humidity below the rated values in order to get the air exactly at the rated values after having collected heat and humidity on its passage through the room when it comes to the sensors. Again the differences of temperature and humidity of the supply-air to the rated values depend on the amount of heat and humidity developed in the room and on the air flow-rate.

Thus the air converging to the vent-hole combined with all air-streams being influenced by heat- und humidity-sources in the room will represent only an average of the rated value.

According to these considerations it is recommendable to place the sensitive equipment and/or the area of measurements behind the sensors and in front of the first source of heat or humidity according to the air-flow-direction in order to get the sensitive equipment or area of measurements into a stream of genuine, unaffected air with correct conditions.

Therefore it is the best to have the sensors movable for optimum positioning between supply-air inlet and the equipment in the line of air flow. But also with the sensors inside the supply-air ducts a good positioning of the equipment inside the flow of genuine air will in general be possible.

It is usually not recommended for measuring rooms to place the sensors into the vent-air ducts because in this case the equipment will be inside an air-flow with seriously affected conditions, where only the mean values averaged across the entire room represent the corresponding rated values of temperature and relative humidity.

7.2 The distribution of conditioned air

An arrangement of a single supply-air inlet in one corner of the room and placing the vent-air outlet somewhere else would give already reasonable results for lower and medium grade requirements.

Here the supply air penetrates first a major part of the room like a beam with increasing width while mixing the conditioned air at its borders with the surrounding air of the room. When approaching the opposite wall the flow bends and develops a large whirl around the center of the room with some additional whirls in the corners like it is illustrated in figure 4a (from ref. [2]). This configuration is valid for an empty room only.

Close to the vent-air outlet the air will be attracted uniformly from all open directions with a speed rapidly increasing at approaching the outlet. It should be noticed that the position and the orientation of an outlet like this has almost no influence on the kind of air-movement inside the room.

The installations of any (large) equipment will alter the air-movement in the room in an almost unpredictable way. Similarly it will be difficult to find a good location for sensitive equipment which should be inside the genuine flow of conditioned air.

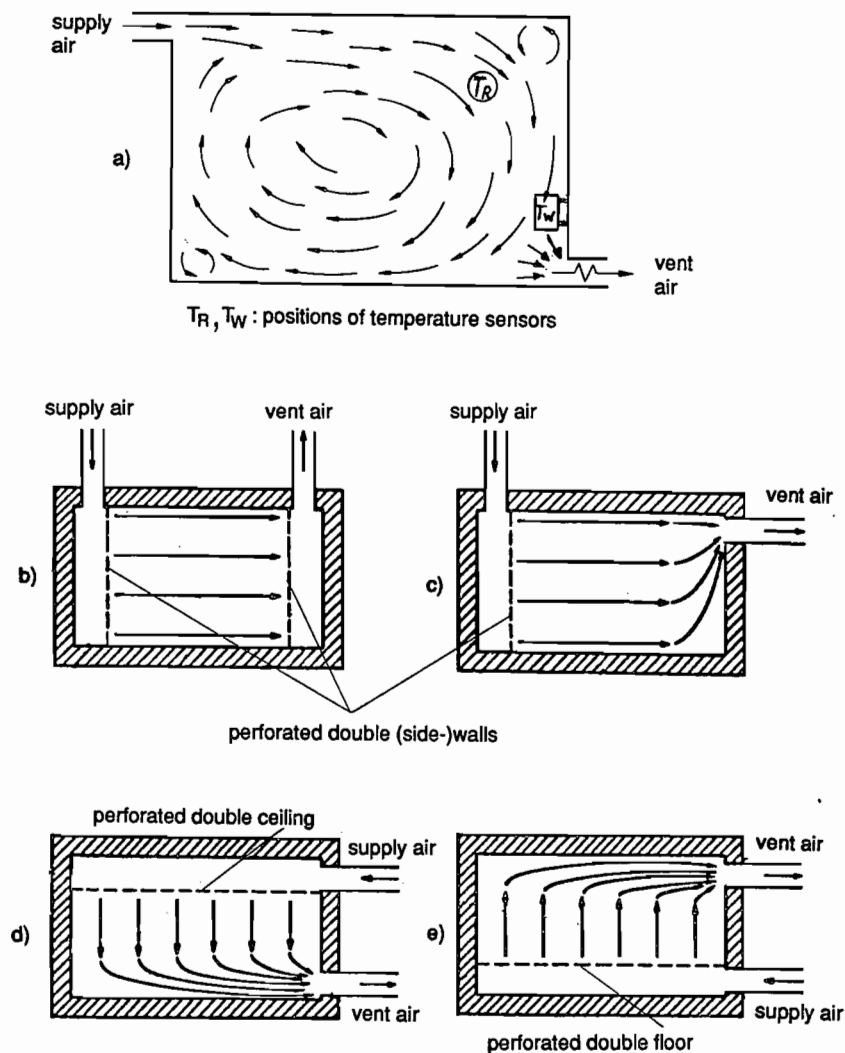

Fig. 4 — Examples of air-distributions

- a) single-hole (or slit) inlet with whirl-mixing of air
- b) horizontal flow, two double walls
- c) horizontal flow, single double wall
- d) vertical flow down, (single) double ceiling
- e) vertical flow up, (single) double floor

Here the best position of the temperature sensor would be in the upper part of the room as it is marked with T_R to measure the "room-temperature". In general the sensors are however mounted on one of the walls (preferably at the location marked T_W on the wall opposite the inlet) with certain distance-keeping parts to reduce the thermal influence of the wall itself.

Anyhow this kind of air-distribution is simple and cheap and results in a reasonable conditioning quality applicable for most of the requirements.

The controlled space is in this case a narrow almost undefined area somewhere down-stream of the (unknown) air-flow behind the sensor.

In order to get this space better defined and to make it as large as possible the air-inlet should be made by using a double wall with a suitable perforation at one side distributing the air-flow almost homogenously across the hole area of the wall. A double wall with perforation could also be used at the opposite side for

the exhaust-air as it is shown in figure 4b (from ref. [3b]). This would result in an almost homogeneously air-flow across the entire space between the double walls, but reduces the utilizable room by twice the thickness of the double walls and increases the cost of installation.

Using a single outlet for the vent-air would cause a bending of the air-stream towards this drain as shown in figure 4c.

In general the advantage of the homogenous air-flow according to figure 4b is only small compared to the disadvantage of additional costs for the installation of a second double wall and for increased running costs due to the increased air-flow-resistance caused by the second double-wall.

In practice the initially homogenous air-flow will anyway be disturbed by the first pieces of equipment being across its path, and remains disturbed on its further way to the outlet double-wall.

Normally a single exhaust vent opposite to the perforated double wall at the air-inlet will give good results if the sensitive equipment and the area of measurements are located close to the double wall supplying the genuine conditioned air at the left side of figure 4c.

7.3 The direction of air-flow

There are three basic directions of air-flow possible each offering some advantages and disadvantages, see ref. [3b].

7.3.1 Vertical air-flow, upwards

In this case of upwards vertical air-flow, the entrance of the conditioned air i.e. the double wall has to be constituted by the floor of the room (see fig. 4e). This could cause certain construction problems, if the equipment is heavy or sensitive to vibrations.

On the other hand this flow-direction supports the thermal air-flow emerging at the heat-sources. This heat will thus be taken out of the room in a very short and rapid way. The heat created by lamps will also be taken out without affecting the equipment below.

Adversely any dust created in the lower part of the room by workers or by certain processes will be blown upwards and distributed into the entire room contaminating horizontal surfaces outside the air-flow.

This kind of ventilation arrangement is suitable for equipment generating large amounts of heat and requiring stable conditions at the same time. This is very common for computer-rooms.

7.3.2 Vertical air-flow, down

Here the flow of conditioned air is coming from the double wall constituting the ceiling and has to overcome the upward directed thermal air-flow of heat-sources (see fig. 4d). This could require enhanced air-flow and increase the running costs.

Additionally in the lower part of the room, specially of the area of the room is large, the space is poorly ventilated at the opposite side of the exhaust-vent. The equipment in these areas is abandoned to an easily affected and undefined climate depending on the heat- and humidity-influences in this area.

Thus this air-flow direction is not recommended, specially if the room area is large and if a double wall at the floor cannot be installed. This kind of air-flow will however keep the dust low.

In these both cases of vertical flow directions a certain minimum height of the room is required for the installation of at least one double ceiling and/or double floor.

7.3.3 Horizontal air-flow

This kind of conditioning, as it has been already described under 7.2 (see fig. 4b,c) offers good advantages in case of rooms with a low ceiling, as no air-ducts or double walls are necessary at the ceiling or at the floor which could reduce the height of the room or create problems in case of heavy equipment.

With respect to extracting the heat generated by the equipment the quality of this arrangement is in between the corresponding qualities for the upward flow direction and for the downward flow direction.

There are also some advantages for arranging the equipment with their most sensitive parts or the measuring area towards the air-inlet side to keep any influencing heat-sources at the downstream side.

The stream of air can be kept horizontal only across a certain distance and the controlled space becomes increasingly poorly ventilated when approaching towards the side of the exhaust-vent (see fig. 4c). So this kind of ventilation should not be used for long rooms or over long distances.

8. Conclusion

As this presentation can give only some aspects of the considerations required for the design of a/c-systems it will never replace the careful planning and design by skilled specialists in air-conditioning.

Giving some impressions about the complexity of this subject it should become clear that easy-made and unreflected solutions of conditioning problems could cause serious equipment expenses and excessively high running costs.

To save money the requirements for the conditioning should first be selected in a manner so as not to be more stringent than necessary for the particular kind of measuring or testing activity. Here it should be noticed that, as an example, an improvement of the temperature-stability from ± 2 K to ± 0.2 K would increase:

- the investment-costs by a factor of about 4 to 6
- the running-costs by a factor of about 5 to 8,

strongly depending on the various details of the design and on many other conditions. Another great increase of costs would occur if in addition the requirements for the relative humidity would be made stringent so as to meet for instance tolerances as low as ± 2 %.

The running costs can be considerably minimized by using as many passive elements as possible such as thermal insulations.

Finally if a certain active a/c-system is really needed it should be exactly made-to-measure by reliable experts.

References

- [1] H. Recknagel, E. Sprenger:
Taschenbuch für Heizung und Klimatechnik. 1981, R. Oldenbourg, München, Wien
- [2] Arbeitskreis der Dozenten für Klimatechnik:
Lehrbuch der Klimatechnik. 1976
 - a) Band 1: Grundlagen
 - b) Band 2: Berechnung und RegelungVerlag C.F. Müller, Karlsruhe
- [3] VDI/VDE-Gesellschaft Meß- und Regelungstechnik:
GMR-Bericht 10; Vorträge zum Aussprachetag: Messräume, Definieren - Bewerten - Klassifizieren
 - a) P. Trittler (Oberkochen):
Anforderungen an die Umwelt beim Einsatz von Koordinatenmeßgeräten
 - b) P. Schmidt (Reiskirchen):
Möglichkeiten der Luftführung und der Temperaturkontrolle in Feinmessräumen
 - c) H. Kunzmann, R. Schwartz, F. Wäldele (Braunschweig):
Ein Meßraum unter Berücksichtigung der Temperaturstrahlung
- [4] OIML/BIML:
Planning of Metrology and Testing Laboratories, March 1986
- [5] Instrument Society of America:
Recommended Practice: Recommended Environments for Standard Laboratories (ISA RP 52.1/1975)

R.P. CHINE

A METHOD for AUTOMATIC CALIBRATION of BELT CONVEYOR SCALES

by

Miss SHI FAN (*) and Mr JIN JUN-HUA (**)

SUMMARY — Alike all kinds of measuring instruments, belt conveyor scales must be calibrated regularly. There are three methods of calibration: captive chain calibration, static weights-hoist calibration and actual material calibration. The first two are easier to be used. However they are approximate calibration methods and can only be used in some applications.

The method of actual material calibration incarnates the real working process of belt conveyor scales and is due to its high precision the only method that is admitted by measurement services but needs a lot of labour and time.

A new kind of automatic actual material calibration instrument is described in this article. At the same time, the method of automatic adjustment of the belt conveyor scale will be discussed.

RESUME — L'article décrit une méthode automatique d'étalonnage et d'ajustage d'une installation de pesage sur bande.

1. The composition of the calibration system

The system (Fig. 1) consists of a store hopper, a weigh hopper, an automatic weights-hoist calibration equipment (used for testing the calibration system itself), load cells and a microprocessor based intelligent controller.

The store hopper is used for storing the material to be weighed. It is an interim instrument between the weigh hopper and the belt conveyor. The store hopper volume is about two percent of the specified amount which is transported by the calibrated belt conveyor per hour. In order to ensure that there is not any remainder of the weighed material, the hopper's inside must be smooth and without protuberance. The emission of the material in the hopper is controlled by the microprocessor based controller.

The weigh hopper is used for weighing accurately and speedily. The weighing system is constituted by the weigh hopper, load cells and a meter. Normally the capacity of the weigh hopper is 1-2 ton. As the store hopper, the weigh hopper's inside must be smooth also.

The dynamic actual material calibration instrument of the belt conveyor scale is checked by the automatic weights-hoist calibration equipment which includes two parts: a group of standard weights and a motor driven lifting assembly. The motor driven lifting assembly is designed to ensure that the weigh hopper does not contact with any part of the weights while loading and unloading.

(*) AVS Electronics Pte Ltd, Singapore.

(**) Shanghai Institute of Process Automation Instrumentation, P.R. of China.

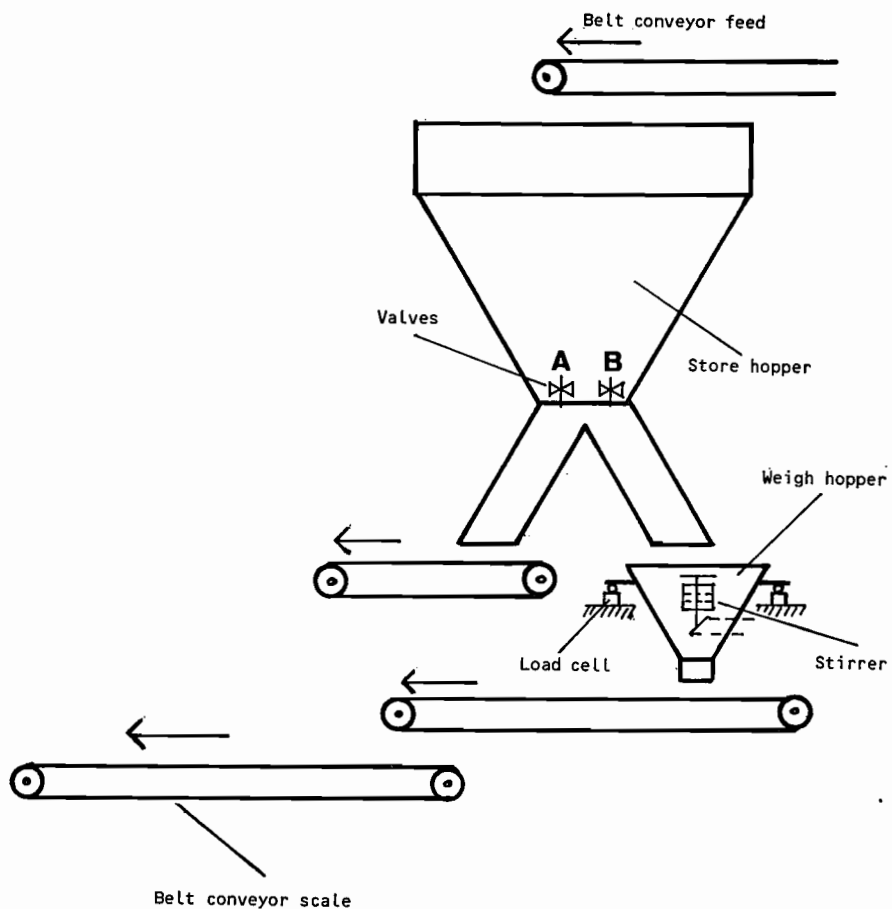

Fig.1 — Principle of automatic beltweigher calibration installation

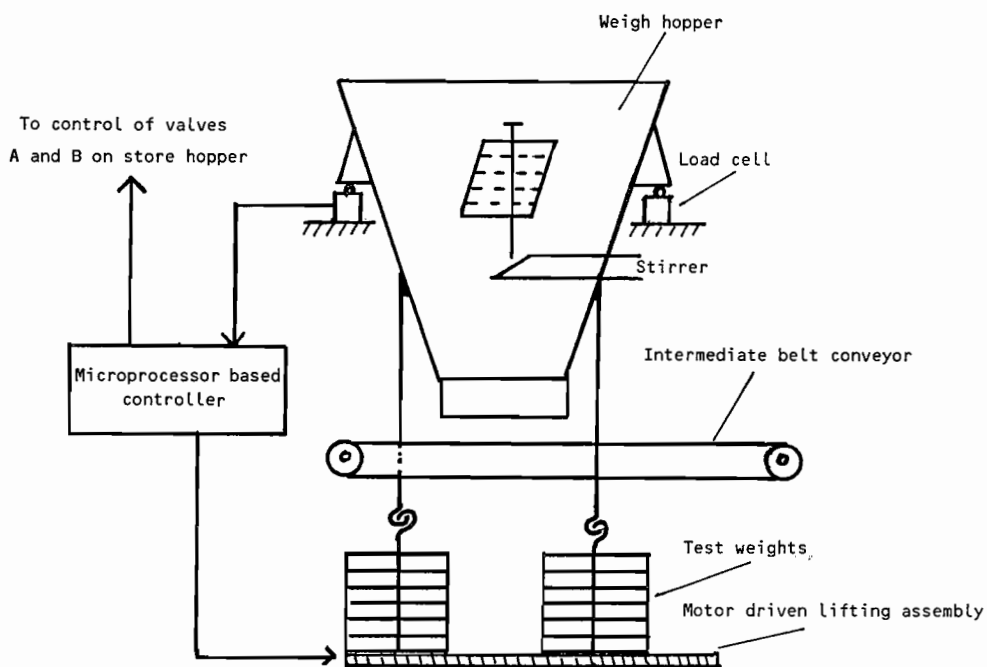

Fig. 2 — Details of weigh hopper

The weight is converted into a digital signal by the load cells and the meter. The microprocessor based intelligent controller controls the discharge depending on the weight of the weighing hopper.

2. The theory of operation

In substance, the calibration instrument is constituted by a highly precise, un-fixed quantity and high speed hopper weigher. It is a static weighing system.

Because the static weighing system is very little influenced by the operational circumstances, it has a very high weighing accuracy. We can use it in the belt conveyor scale actual material calibration.

According to the OIML Recommendation R 50, the material which is used in calibrating a belt conveyor scale is about 3 to 5 percent of the flow quantity per hour. We decide the volume of the store hopper depending on this data. The store hopper is fed in by the belt conveyor, while at the same time, the store hopper discharges its load into the weigh hopper. The handling capacity of the weigh hopper is designed as half of the belt conveyor flow quantity per hour. This half of the load fed by the belt conveyor is discharged into the weigh hopper continuously. The design data is only for reference. It can be changed at wish. The store hopper is not necessary for such a small belt conveyor scale.

The size of the weigh hopper is determined by the conveyor flow rate and structure. The larger the weigh hopper is, the better will be the flow rate and vice versa.

Based on the modern static weighing technology, the process of loading, delaying, data sampling, data processing and discharging can be done in ten seconds. That is the weighing time is about ten seconds. Because it is an unspecified quantity weigh system, the weighing time is much shortened. For a 3 ton hopper, the handling capacity may reach 1 000 ton per hour. That is suitable for most belt conveyor scales.

As a calibration instrument, the weigh hopper must be accurate enough itself. And its high precision ought to be proven at any time. The automatic weights-hoist calibration equipment is made for this purpose (Fig. 2). It is used for calibrating the belt conveyor scale calibration system. As mentioned above, the motor driven lifting assembly of weights-hoist equipment must be very accurate, so that the load and unload can be done in right way. The accuracy of the weights is 0.005 %. The total sum of the weights should be equal to the weigh hopper capacity.

To ensure the high precision, the belt conveyor calibration system should be tested before use. The load cells and the meter are the key part of the calibration system. Besides the high precision of conversion and high converting speed, these parts can compute the loading speed and activate a signal to stop loading. By the automatic tare and tret function, the extra error due to the remained material in the weigh hopper can be eliminated. In order to get a large handling capacity, the electric weighing system is designed as an un-fixed quantity.

The weighing is controlled by the microprocessor based intelligent controller. By the precise control, the weigh hopper is neither overloaded nor with too little content.

3. The automatic calibration of belt conveyor scales

The automatic calibration of belt conveyor scales can be realized by the instrument described above.

The instrument should be installed in a suitable place. In a new belt conveyor scale, the instrument may be placed in the front of the belt conveyor scale, as shown in Fig. 1. In normal time, the store hopper is used only as a passage. When the valve A is open, and the valve B is closed, the material is discharged into the next belt conveyor other than the weigh hopper. When doing calibration, the valve A is

closed and the valve B is open. At this time, the static weighing system works. The material that just has been weighed is transported into the belt conveyor scale. The material is first weighed by the static weighing system, and then by the belt conveyor scale. While in an old belt conveyor scale, the instrument should be installed behind the scale, the calibration process is just opposite. The material must be transported without any leakage. To do the calibration, the microprocessor based intelligent controller is turned on first. After about 15 minutes, the system will be in a stabilized state.

A reading is taken of the empty weigh hopper. The automatic weights-hoist instrument is then switched on loading the whole of the weights onto the weigh hopper. The value of the weigh hopper with all the weights is read and recorded. Now the zero point and the full scale are obtained. The operation is repeated three times. If the zero point and the full scale indication are not changed, the system is then considered working perfectly.

The zero point is adjusted when the weigh hopper is empty. Then, after loading with all the weights, the full scale key of the meter is pushed. The full scale indication is thus adjusted automatically. The accuracy of the weighing system is 0.05 %. It is accurate enough for a belt conveyor scale calibration instrument. After doing the above preparation, the actual calibration with material may start.

The belt conveyor is turned on to load the store hopper. At the same time, the store hopper discharges its content into the weigh hopper. The microprocessor based controller samples the weight value, and calculates the loading speed. The stop load signal is sent out by the controller, when the weight of the hopper is near the specified quantity. The controller records the weight value. After a few minutes, the weigh hopper discharges. Till now, one weighing process is finished.

The weighing process is repeated until all of the material has passed through the weigh hopper. The belt conveyor scale is then adjusted according to the value shown by the meter and the calibration process is completed.

The accuracy of the global calibration process is 0.1 %. The system is being used in a power plant in the south of China.

AUTOMATIC RAIL-WEIGHBRIDGES

by Roger ROBINSON

National Weights and Measures Laboratory
Teddington

SUMMARY — This paper was presented to delegates from industry at a seminar on industrial weighing hosted by Statens Provvningsanstalt at their premises in Boras, Sweden on 20 September 1989. The paper gives a résumé of automatic rail-weighbridges; that is, weighing instruments installed on a railway track and designed to operate while the wagons to be weighed are in-motion. Test procedures and maximum permissible errors are then described according to the OIML 1st Draft International Recommendation dated May 1989 (). The final section compares the accuracies of different automatic weighing instruments and discusses how automatic rail-weighbridges might be developed.*

The need for requirements

Scope of legal control of measuring instruments

Retail transactions are likely the historical basis for traditional "weights and measures" regulation and in some states the more modern term "legal metrology" is still restricted to retail sales. Elsewhere the particular needs of manufacturing industry and specialised services have extended the boundary of legal metrology. For example, in the UK since 1963 (excluding EEC Directives) the criterion for legal control is "use for trade". This means any transaction involving the exchange of money or monies-worth and includes some quite obscure arrangements such as employees' bonus payments related to productivity when calculated by using the weight of produce. In such circumstances the weighing instruments used have been subject to legal control. Some countries extend the scope of legal control of measuring instruments by including those used for medical or health purposes and there are one or two countries which control all instruments which indicate or display the result of a measurement.

Delegation of responsibility

In the UK, the legal control of industrial weighing instruments used for trade arose from the desire of contracting parties for a fair independent arbiter. This task is shared by:

- local government who are responsible for both the verification and in-service checking,
- central government who take responsibility for pattern evaluation.

However, administrative arrangements will vary throughout the OIML member states but delegation of responsibility for legal metrology within each state should not affect interpretation and implementation of an OIML Recommendation such as currently drafted for automatic rail-weighbridges (ARW).

[*] The vote on this draft has not yet been completed. Though unlikely, the paper may thus on a few points present slight divergencies with respect to the final version of the Recommendation to be adopted.

Origins of in-motion weighing

For UK experience of railway in-motion weighing we can refer to commentary and reports by local government inspectors responsible for verification. From such records it seems that in-motion weighing has been practised for as long as there have been railway weighbridges which implies considerable abuse of non-self indicating instruments. The accuracy of such weighing operations is not necessarily related to the instrument but rather more dependant upon influence quantities such as train speed, rail conditions, wagon conditions and meteorological conditions. The advent of self-indicating weighing instruments must have been considered a technological breakthrough but their use for in-motion weighing must have required much guessing of the extent which the indicator was controlled by the inertia of the system. A report on such a test was done as an investigative project by a UK local government authority in 1910 [1].

The use of non-automatic weighing instruments for in-motion weighing was long known, if only for the fact that for certain applications it would otherwise have been impossible to "weigh correctly" each wagon in the time available. Correct non-automatic weighing means uncoupling each wagon in turn when correctly positioned on the load receptor prior to weighing, with considerable shunting by the locomotive between weighings. Furthermore, the type of locomotive used for pulling as many as 100 coal wagons is not the most ideal type for use in shunting wagons.

Legal recognition of in-motion weighing

It was about 1963 when instruments designed for in-motion weighing were first subjected to trials in the UK by manufacturers, Local Government inspectors and Central Government Examiners. The maximum permissible errors applied as a result of the trials were a relative error of 0.5 % of a train of wagons when only the total of the train load is required.

If individual wagon weights are required then the same relative error is applied but only for wagons heavier than a given fraction of the maximum capacity of the instrument. This last point is important because it recognises the high relative errors occurring with relatively small loads due to the dynamic effects of the operation. The large relative errors resulting from in-motion weighing occur for a different reason to those from non-automatic weighing and the effect in the former is of greater significance to the weighing result. This is further discussed later under the section on "commentary on maximum permissible errors".

A ten year trial period was applied to the successful patterns to ensure this method of weighing was valid. A notable additional test applied from those early days was that of accuracy in a non-automatic mode to comply with that of non-automatic weighing instruments of the same maximum capacity. The validity of this requirement is debatable, particularly if a pattern is so designed that for use in a non-automatic mode an automatic rail-weighbridge has to be switched to a different method of operation to process the transducer output. This test is now notably omitted from the document which describes the test presented in this paper.

Testing methods

Before describing the test methods for in-motion weighing instruments it is necessary to consider the purpose of the test from first principles.

Traceability

The purpose is to assess the integrity of the instrument by using equipment of established integrity. This involves the philosophy of traceability, a chain which links the accuracy of any metrological equipment with a particular nation's primary standards or to international standards. In this traceability chain beginning with the equipment under test, each link has to be of greater accuracy than that of the previous link.

The reason this principle is introduced here is that in the case of non-automatic weighing instruments, as with many other measuring instruments, the verification test usually involves only one stage in the traceability chain. That is the comparison between standard weights and the weight indication on the instrument.

In the case of in-motion weighing instruments, as with many other types of automatic weighing instruments, the verification test involves two stages in the traceability chain. This is because it is not practicable to use standard weights as the load for each of the test wagons used in the test train.

Summary of test

The verification requires an appropriate test train comprising loaded and unloaded reference wagons. In the first stage, each reference wagon is weighed using a non-automatic weighing operation to give them the status of a standard weight and in the second stage, they are used in a normal (automatic) weighing in-motion operation. The accuracy of the automatic rail-weighbridge will then be assessed by comparing the in-motion weighing results with the non-automatic weighing results.

Draft International Recommendation test procedure

The initial verification test procedure described here, follows the OIML First Draft Recommendation for Automatic Rail-weighbridges dated May 1989. Initial verification being the action taken to confirm that a new or repaired measuring instrument conforms with legal requirements. The metrological tests for accuracy are only a part of the initial verification although in the case of automatic rail-weighbridges they comprise by far the most time consuming and expensive part. This paper is restricted to those metrological tests.

The test requirements and procedures for both pattern evaluation and verification are similar. The main difference is the requirement for normal operating conditions for verification but for pattern evaluation a maximum of five reference wagons are required to yield at least 25 weighing results for uncoupled wagon weighing and 60 for coupled wagon weighing.

One of the problems for the submitter of a pattern is to persuade a potential purchaser to have an instrument without pattern approval installed in his railway so that pattern evaluation tests can be done. The evaluation of an automatic rail-weighbridge is dependent, amongst other things, on the results of a weighing in-motion test which can only be done on a complete installation. These tests use considerable time and resources so in sympathy with this the Draft Recommendation requires the testing authority to permit the pattern evaluation results to be used to assess the same instrument for initial verification. Any other necessary inducements rest between manufacturer and purchaser of the instrument.

Control instrument

It is the control instrument which will be used to determine the mass of the reference wagons and these values will be used to determine the accuracy of the in-motion weighing results. The planning of the test must begin with the choice of control instrument. It is most important that this choice be made at the planning stage of the ARW, prior to installation. Otherwise it might not be possible to test it.

Verification standards for control instrument

The qualifications for a control instrument are given under the title "verification standards". These require that the mass of the reference wagons can be determined with an error not greater than either:

- (i) 1/3 of the maximum permissible error for in-motion weighing, if the control instrument is verified immediately before the in-motion tests, or
- (ii) 1/5 of the same value if verified at any other time.

These conditions are intended to give equivalent levels of confidence for the two circumstances. In the case of the alternative (ii), a more restrictive requirement is necessary to compensate for deterioration of the control instrument with time and use.

Integral control instrument

It is most convenient to be able to use the ARW itself as a control instrument. For this to be acceptable it must be possible to use the instrument in a static weighing mode and the Draft Recommendation makes provision for this by prescribing a regime of maximum permissible errors for static weighing related to the scale interval and declaring the manner in which they are to be applied. It follows that for this mode of use the instrument must be designed so that the scale interval is related to the requirement for verification standards mentioned previously. The test procedure for static weighing does not need to follow the broader and more complex requirements for non-automatic weighing instruments because the latter type of instrument has to:

- continue in use long after testing,
- be used by persons who may not be trained or have technical knowledge or skills,
- be used under varying conditions and with varying products.

In contrast to this the said test procedure for static weighing is for one specific use and has only to satisfy the needs of that use.

Partial weighing control instrument

The main problem with using the ARW as its own control instrument is that many patterns are designed for partial weighing. This means a wagon can not be weighed in less than two parts, each comprising a separate weighing operation and obviously at different moments in time.

It is possible to achieve the necessary integrity. The problem is to prove that it is doing so. It is a problem for three main reasons:

- (1) the weighing of a reference wagon unloaded and loaded with standard weights would be necessary to confirm that the difference in the results of the unloaded and loaded weighings was equal to the designated mass of the standard weights. However, the design of most wagons makes it difficult to load them with standard weights and even if this were not so it would be impracticable (or even impossible) to find enough mass of standard weights to load each reference wagon.
- (2) if a convenient flat-bottomed wagon is used as substitute so that standard weights can be partially weighed, it is unlikely the wheelbase will be the same as the wagons which will be weighed in normal use or that the load will be distributed in the same way. So the moment of inertia about each axle will not mimic that in normal use particularly if there is any variation in the incline of the rails between the axles during in-motion weighing.
- (3) to ensure there are no discrepancies due to either non-linearity of the suspension or different rates of compression of the suspension over each axle, a number of different values of standard weights would have to be used in the test.

To overcome these problems would demand a disproportionate commitment of resources so to pursue this route would not be practicable. However, the Draft Recommendation does make provision to use the partial weighing instrument as a control instrument. This provision is based on a procedure practised in the UK since ARWs were first permitted to be used for trade. However, it is a compromise because even if the procedure is faithfully followed, it involves a calibration at only one value of mass in the weighing range. The procedure is described in a previous publication [2].

Full draught control instrument

ARWs which operate in full draught fashion can be relatively conveniently used as the control instrument and as there will not always be a non-automatic rail-weighbridge already installed in the vicinity this will normally be the favoured option.

In-motion tests

At this stage the means to find the mass of the reference wagons has been established.

The factor which decides how next to proceed with the in-motion tests is the method of weighing in-motion designated for the ARW. The three methods recognised by the Draft Recommendation are:

- (i) uncoupled wagon weighing defined as
weighing in-motion of wagons which travel independently across a load receptor.
- (ii) coupled wagon weighing defined as
weighing in-motion of a train of coupled wagons to obtain a weight indication or print-out of the individual wagons.
- (iii) train weighing defined as
weighing in-motion of a train of coupled wagons to obtain a totalised weight indication or print-out representing the sum of all the wagon weights.

Uncoupled wagon weighing

This method of use has the least disadvantages and this is reflected in the in-motion test procedure. At least five reference wagons are chosen for testing, having a range of loads from zero, in other words tare weight, to that of a fully loaded wagon. Initially the mass of each reference wagon must be determined by the control instrument. The reference wagons will then be used as if in a normal in-motion weighing operation giving a second set of values. The difference between these two sets of values taken wagon by wagon is considered the error of the in-motion weighing operation. Each reference wagon must be weighed in-motion at least five times which means there must be a minimum of 25 in-motion weighing results. If there are any factors which affect the speed of the wagons when weighed in-motion then these should also be applied to ensure that the normal range of speeds is realised during the test.

Coupled wagon and train weighing

The test procedure for these two weighing in-motion methods are exactly the same. The only difference is in the manipulation of the results and their evaluation.

Dealing first with the procedure, a test train shall be comprised of a number of wagons which will be typical of an in-motion weighing operation. However, not every wagon in the test train has to be a reference wagon. The Draft Recommendation takes into consideration the fact that in some states trains can comprise hundreds of wagons. With such long trains it would not be practicable to do static weighing on each wagon. Static weighing requires a considerable commitment of resources in the form of equipment, personnel and time so the Draft Recommendation specifies a compromise procedure.

In test trains of 10 wagons or less, all the wagons must be reference wagons but for longer trains the minimum number of reference wagons required remains at ten until the size of the train exceeds 30 wagons. In this last category the number of reference wagons must not be less than 15. Therefore it will be common practice to have test trains in which not all the wagons are reference wagons. The only additional requirement is that in these circumstances the reference wagons must be distributed throughout the test train. This does not mean that the sequence of wagons

should be rearranged after each test run. The Draft Recommendation does not require that every wagon position has to be occupied by at least one reference wagon in at least one test run.

The relatively easy part of the test is then to monitor the test runs using the test train. Test trains should be used in the same manner as they would in normal use. This means in particular:

- the range of wagon loads; that is fully loaded, empty (tare weighing) or partially loaded wagons,
- one or both directions of travel over the load receptor,
- the normal range of speeds or variation of speed with each test run,
- the correct branch of the approach rails if there happen to be alternative rail tracks,
- the use of an unloading facility if the train length happens to straddle both weighing and unloading facilities at the same time.

There will be other features to consider which are particular to each installation.

Maximum permissible errors

The determination of maximum permissible errors (mpe) for ARWs is possibly the most complicated of any measuring instrument. The Draft specifies four accuracy classes for ARWs. For each class a relative mpe is given for initial verification but this value is not necessarily calculated using the mass of the reference wagon. To explain this the mpe for wagon weighing is best described first.

Maximum permissible errors for wagon weighing

The basis for the calculation of the mpe is simply a fractional percentage of the mass of the load weighed. However, the unit load to be weighed cannot be less than a whole wagon weight and so on a single axle load receptor the load weighed will comprise at least two weighings. The reasons for this requirement are:

- (1) to equate the accuracy of partial weighing with full draught weighing on ARWs of the same accuracy class and
- (2) because a single axle weight cannot be attributed to any specific proportion of the load, regardless of how the load is distributed in a wagon and no matter how ingeniously the attempt to electronically segregate it.

This is a fundamental principle for trade transactions and as a consequence the Draft requires that the maximum wagon weight be designated as well as the maximum capacity. So errors are calculated by reference to each wagon weight instead of to an axle or bogie weight and it would not be practicable to do otherwise. A corollary of this is the requirement to print at least each wagon weight unless the normal mode of use is for train weighing.

The error on each reference wagon weight as a result of weighing in-motion will be found by reference to the mass of the reference wagon determined by use of a control instrument. The difference shall not exceed a mpe calculated as a fraction of either the mass of the reference wagon or 35 % of the designated maximum wagon weight, whichever is the greater. Finally, to avoid the possibility of awkward circumstances the mpe cannot be less than one scale interval (d). With this regime the mpe is never less than:

- a quantity related to the specification of the automatic rail-weighbridge,
- some fraction of the mass of the reference wagon.

To summarise: the maximum permissible error will be the greatest of 3 parameters:

- (1) a direct proportion of the mass of the reference wagon as prescribed for the accuracy class

- (2) the same fraction of 35 % of the maximum wagon weight as marked on the instrument
- (3) one scale interval.

This regime of mpe was considered reasonable for uncoupled wagon weighing but for coupled wagon weighing it assumes that individual wagon characteristics do not affect the weighing operation and the weighing error of a wagon is not affected by its position in the train. As neither of these assumptions is true and neither of these influences can be attributed to the ARW, there is a concessionary requirement which is only applicable to coupled wagon weighing. This allows 10 % of all the weighing in-motion results to exceed mpes from the regime described above but each must not exceed twice the appropriate value. In this context "all the weighing in-motion results" means the results for all the reference wagons from all of the in-motion test runs.

Maximum permissible errors for train weighing

The maximum permissible errors for train weighing are merely a scaled-up version of those for wagon weighing with some additional constraints. Each evaluation requires a summation of the weighing results from all the reference wagons and this is compared with the totalised mass of all the reference wagons. The difference will be the error which again must not exceed the greatest of three parameters, the first of which is a direct proportion of the totalised mass in accordance with the designated accuracy class.

The second parameter again applies a 35 % proportion of the maximum wagon weight, now multiplied by the number of reference wagons in the test train but not exceeding ten.

Similarly, the third parameter is one scale interval times the number of reference wagons but not exceeding ten.

Commentary on maximum permissible errors

There are two aspects of the application of maximum permissible errors which merit further comment:

- the calculation of 3 parameters with each weighing operation
- the additional constraints applied to train weighing results.

Parameters for maximum permissible errors

The choice of application of the appropriate relative maximum permissible errors for a given accuracy class is a recognition of the large relative errors which generally occur with weighing in-motion when the mass of the wagon tends towards the lower end of the weighing range. This trend occurs because there is insufficient mass to dampen such effect as chattering between wagons, wagon suspension and frequencies generated when the wagon hits the load receptor.

It is generally recognised that a relative error which can reasonably be applied in the upper half of the weighing range becomes very difficult to meet when tare weighing empty wagons. For this reason a "minimum" maximum permissible error was conceived to ensure that an ARW can be used over a reasonable weighing range. This could be referred to as the horizontal parameter because it means that when plotting maximum permissible error on a vertical axis against the mass of a wagon, the zone of permissible errors is bounded initially by a horizontal line until it intersects the relative proportionate error line which would have passed through the origin. Figure 1 illustrates this.

The third parameter which does not allow a maximum permissible error of less than one scale interval is of course for convenience. It avoids the need for further impracticable evaluation on such occasions when 35 % of maximum wagon weight is exceeded by one scale interval.

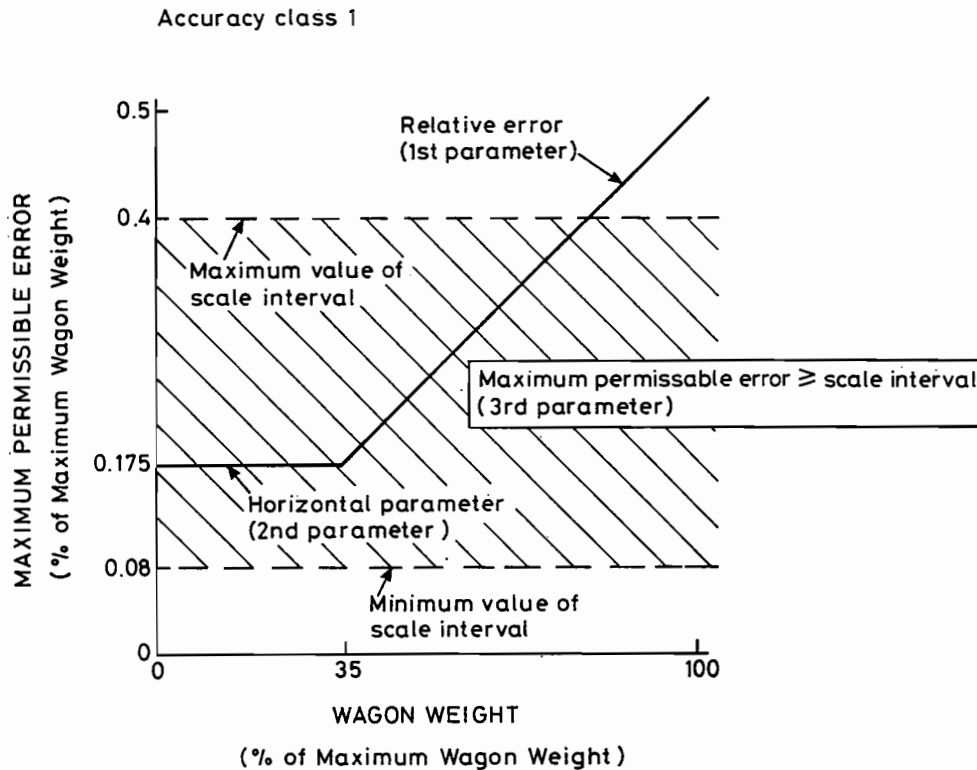

Figure 1 — Relationship between maximum permissible error and wagon weight

Constraints on train weighing errors

For any ARW with a given accuracy class, the requirements for train weighing are easier to satisfy than those for coupled wagon weighing. This is probably because during coupled wagon weighing the positive and negative errors occurring throughout a train are averaged out when train weighing. In other words, the mass of the train might be a constant but the weight will emanate through the wheels in a variable way. A notable effect of this is the usual excessive error on that wagon coupled directly to the locomotive. This wagon bears either the greatest compression force through the buffers when the locomotive is pushing the wagons or the greatest tension through the couplings when the locomotive is pulling the wagons. Such effects have been known to prevent verification to wagon weighing requirements, whereas total train weighing to a higher accuracy class might be possible for the same ARW.

In addition, a given train weighing accuracy is likely to deteriorate less towards the lower end of the weighing range. It might even be considered unnecessary to have the so called "minimum" maximum permissible error or horizontal parameter mentioned previously. However, this has been kept for continuity but to reflect the relative ease with which the accuracy for train weighing can be maintained for larger trains the effect of the horizontal parameter has been reduced. This is achieved by not increasing the multiplying factor when exceeding ten wagons. In other words there is a maximum value for the "minimum" maximum permissible error.

Significance of accuracy classes

The International Working Group (IWG) for OIML SP 7 Sr 5 has purposely harmonised the designations of accuracy classes for all types of automatic weighing instruments by designating each accuracy class in accordance with a prescribed relative maximum permissible error. However, the application of this prescribed value varies

with each type of automatic weighing instrument so errors through weighing a load using a class 1 ARW will not necessarily be similar to those of any other type of automatic weighing instrument designated class 1. They may be better or worse because there are advantages and disadvantages in the use of each type of automatic weighing instrument. Therefore, it is important to be aware of these and consider the consequences before a type of instrument is chosen for a particular application.

Two main factors affecting the accuracy of the weighing result for a given load when using an ARW are:

- (1) the need for both a gross and a tare weighing operation to obtain a net weight of the load
- (2) the tendency for accuracy to deteriorate towards the lower end of the weighing range.

The first factor is of course detrimental because the two resulting errors from gross and tare weighing could be of opposite sense thereby compounding the error. Despite the necessity for double weighing to determine the weight of the load in the wagon it has not been considered practicable to devise a test regime which mimics this mode of use and to aggravate this remission there is little that can be done in normal use to restrict the time lapse between tare and gross weighing. This means that other factors affect net accuracy such as wear and tear on wagons, loss of residual material or perhaps gain of material from say overhead conveyor systems or even rain, snow and ice. Finally, no attempt has been made to enforce both tare and gross weighing operations on the same ARW.

The second factor above involving accuracy degradation with smaller loads, has already been mentioned as a justification for the "minimum" maximum permissible error also labelled the horizontal parameter. Though a similar problem occurs in other weighing instruments it does not do so to the same degree. This is because below some critical zone there is insufficient mass to dampen the dynamic effects of weighing in-motion. Complying with a relative maximum permissible error will then be excessively difficult when empty wagons are tare weighed. Furthermore, although there should be a minimum capacity for the instrument this will normally reflect the size of the smallest wagon to be used. However, there is no such minimum restriction on the load within the wagon. Taking this to a ridiculous extreme it means a load in a wagon could be less than one scale interval and in this case the maximum permissible error on the net load would be a nonsensical value by comparison. Suffice to say, considerable responsibility rests with users and operators to ensure that wagons required to be weighed are loaded sensibly.

There are also significant but variable influences which are difficult to control such as:

- the condition of each wagon, particularly wheels, tyres, brakes and bearings,
- the condition and layout of the track and any track features within a train length of the load receptor.

The object of this section is not to deprecate ARWs but to give guidance on the implications of a designated accuracy class. There are applications for which ARWs are better suited than any other weighing instrument. But for a given accuracy requirement the above factors are more relevant than the constants used to designate the accuracy classes for automatic weighing instruments.

Trends in development

Designs of ARWs have progressed over the last 15 years in step with advances in micro-electronics. This means greater sophistication in the processing of a transducer output and more features and facilities all within a smaller package. In fact the limiting factor on the size of the control unit is now probably the descriptive plate. But these advances are mainly in harmony with those of all measuring instruments and are not specific to ARWs.

One aspect of ARWs which is ripe for development is in the load receptor, both with respect to the pit work and the transducer. Traditional designs of load receptor are based on the theme that a large mass of supporting steelwork and concrete is better able to absorb the undesirable oscillations of dynamic weighing and as a consequence, a deep robust pit construction is required.

However, to follow these ideals is costly both in time and materials so such structures need to remain in use for some time to make them worthwhile. Experiments have been done with shallow pits for at least ten years in the UK and ultimately there will be a trend towards patterns which do not have a pit. This means the installation will be considerably cheaper and presumably the components of such a load receptor will have some degree of mobility and ease of replacement.

Some manufacturers are currently publishing brochures claiming these aims have been achieved and technical articles have been in the public domain describing such systems since at least 1982. Furthermore, patents were published in the UK in 1978 and 1988 which describe use of the rail as a transducer. These were preceded by a USA patent published in 1973 which was also dedicated to this theme. So the idea is not new but at the time of writing pattern approval remains a target. It might now be only a matter of time before the load receptor for an ARW is described merely in terms of the rails and the manner in which they are supported.

References

- [1] McQuown S.H. Experimental investigations into railway truck weighing made on the Clydebank. Standards Department, Board of Trade, UK, 1910.
- [2] Robinson R., Testing of automatic rail-weighbridges. Bulletin OIML No. 101, December 1985, pp. 23-34.

URSS

GOSSTANDART'S EXPERIENCE in DESIGNING and EQUIPPING METROLOGICAL and TEST LABORATORIES *

by **A. VISHENKOV**

The State Committee of the USSR for product quality control and standards (the USSR Gosstandart) is a national organ responsible for state administration and carrying out activities on standardization, quality control and metrology in the country.

The USSR Gosstandart directly cooperates with state government bodies, ministries and departments as well as with the country's industrial enterprises.

Within the structure of the USSR Gosstandart there are 15 republican boards in each Union Republic, more than 250 regional laboratories of state supervision over standards and measuring instruments, 20 scientific research institutes, 40 industrial enterprises manufacturing and repairing high-precision measuring and test equipment, 2 design bureaus, 4 educational establishments with their branches in many cities.

The stock of primary standards of the USSR includes over 140 units and 500 secondary standards for reproducing and maintaining about 70 physical quantities in all kinds and spheres of measurements.

The USSR Gosstandart has acquired a great experience in designing and equipping metrological and test laboratories, both in the USSR and abroad.

The USSR Gosstandart has a specialized organization: "The State Institute for designing enterprises, buildings and installations" ("The Giprostandart"), which designs scientific research metrological institutes, verification and test centres, plants manufacturing and repairing reference and working precision measuring instruments.

During 22 years of its existence the institute designed more than 150 units which function effectively in various climatic conditions of the USSR. Among them are: a new Metrological research establishment of VNIIM in the town of Lomonosov near Leningrad, the biggest Moscow metrological centre, centres for standardization and metrology in Soviet cities: Tashkent, Dnepropetrovsk, Leninakan, Krasnodar, Tula, Alma-Ata, Togliatti, Rostov-on-Don, Khmel'nitsky, Rovno, Sevastopol, Novosibirsk, instrument-making plants in Moscow, Volgograd, Kharkov, Riga and in some other cities.

"The Giprostandart" makes a wide use of progressive national and international experience in creating conditions for keeping and exploiting national primary and secondary standards for measurement units of physical quantities, verification of reference and working measuring instruments. Projects provide for application of up-to-date technical design of engineering equipment and communication facilities which ensure thermostating and conditioning of work rooms with a rigid temperature regime (some rooms with the temperature up to 20 ± 0.1 °C), protection from electromagnetic interference, vibration, noise, acoustic vibrations and dust.

(*) Presented at the OIML seminar on Planning and Equipping Metrology and Testing Laboratories Paris, 25-26 September 1989.

Depending on the needs of an economic region, the composition and structure of the metrological centre of this region may vary — area from 1 200 m² to 20 000 m², and the number of instruments from 1 to 10 000 pieces.

Metrological centres have divisions for testing different kinds of products (food-stuff, textile articles, building materials and constructions, electrical items, domestic equipment, measuring instruments, etc.) as well as for various types of tests (acoustic, vibration, climatic, mechanical, electromagnetic compatibility, etc.). Soviet-made and foreign-made equipment of the test centres allow to test and certify all properties of the product.

The metrological level of verification laboratories of the centres for standardization and metrology meets the highest requirements of customer organizations and enterprises.

Depending on the industrial and scientific potential of a region, a centre may contain the following laboratories:

- measurements of dimensional quantities ensuring verification of instruments to measure length, angles, surface roughness parameters, surface involute parameters, deviation from linearity, flatness and roundness, coat thickness, temperature coefficient of linear expansion of solids;
- measurements of mechanical quantities ensuring verification of instruments which measure mass, hardness, force, vibration and shock parameters, torque;
- measurement of flowrate, level, volume of liquids and gases;
- pressure and vacuum measurements;
- measurements of composition and physico-chemical properties of substances ensuring verification of instruments measuring density and viscosity of liquids, pH-value and specific electrolytic conductivity of solutions, humidity of liquids, gases and solids;
- thermophysical and temperature measurements for verification of instruments measuring quantity of heat, heat conduction and specific heat of solids, temperature;
- time and frequency measurements;
- measurements of electrical and magnetic quantities for verification of instruments which measure direct and alternative current, electromotive force and d.c. voltage, electrical resistance, inductance, capacity, power, magnetic flux and induction;
- radioelectronic measurements;
- measurements of acoustic quantities;
- optical and opticophysical measurements;
- measurements of ionizing radiation.

“The Giprostandart” also designs instrument-making and instrument-repairing plants for manufacturing and repairing electro-radio-thermal measuring equipment, weighing instruments, instruments for linear and angle measurements, etc. These plants have metal working, radio assembling, galvanic, assembling and other production shops necessary for manufacturing the above-mentioned equipment.

Projects elaborated by the Institute provide for, if necessary, works which require special conditions: absence of dust (particles' content in the air from 5 to 35 000 in 1 m³), thermostating of production areas to various temperatures, humidity control within the required limits.

Projects meet all the requirements of the building code, sanitary norms, safety regulations and fire safety.

During 1973-1989 over 20 metrological centres and laboratories were built and equipped abroad, several thousand types of measuring and test equipment were delivered to these centres with the assistance of the USSR Gosstandart.

Besides, over 200 foreign specialists are educated and trained annually in educational and scientific organizations of the USSR Gosstandart and abroad.

The metrological centres of the USSR Gosstandart carry out certification and calibration of standard and working measuring instruments at the request of foreign countries.

Possessing a strong scientific and industrial basis, the USSR Gosstandart offers over 1 000 scientific and technical services to Soviet and foreign partners, including development, manufacture and delivery of more than 350 types of working and reference measuring instruments, reference standard materials. Over 200 kinds of services cover tests and calibration, expertize and working out normative documents in the field of metrology. The USSR Gosstandart also offers more than 100 kinds of information services.

TRAVAUX de l'OIML

WORK of OIML

1989-1990

Nous indiquons ci-après sous une forme condensée et bilingue l'état de préparation des Recommandations Internationales, Documents Internationaux et autres travaux de l'OIML tel qu'il découle des rapports annuels et autres informations reçues par le BIML.

Dans cette liste ne sont pas inclus les sujets dont les travaux ont donné lieu à des publications définitives parues avant 1989.

Les avant-projets et projets indiqués dans cette liste ne sont disponibles que pour les membres des groupes de travail concernés.

We are hereafter indicating in a condensed and bilingual form the stage of preparation of International Recommendations, International Documents and other work of OIML as it appears from the annual reports and other information received by BIML.

This list does not include work which has been subject to final publication before 1989.

The preliminary drafts and drafts mentioned in this list are available only to the members of the respective working groups.

LEGENDES

AP	=	Avant-projet <i>Preliminary draft</i>
P	=	Projet <i>Draft</i>
Enquête	=	<i>Enquiry</i>
Préparation	=	Elaboration d'un avant-projet <i>Preparation of a preliminary draft</i>
Etude Sr	=	Observations et nouvelle version étudiées par Sr <i>Comments and new version studied by Sr</i>
Etude SP	=	Etude du projet par le Secrétariat Pilote <i>Study of the draft by the Pilot Secretariat</i>
Vote CIML	=	Vote par le CIML sur le projet <i>Vote on the draft by CIML</i>
D	=	Document International
R	=	Recommandation Internationale

Secrétariat	Titres abrégés des sujets <i>Short-form titles of subjects</i>	Forme de publication <i>Status</i>	Etat de préparation <i>Stage of preparation</i>	
			1989	1990
SP 1	TERMINOLOGIE <i>TERMINOLOGY</i>			
Sr 3	Conformité terminologique <i>Conformity of terminology</i>		Activité permanente	
SP 2	METROLOGIE LEGALE, GENERALITES <i>LEGAL METROLOGY, GENERAL</i>			
Sr 2	Unités de mesure légales (revision D 2) <i>Legal units of measurement</i>	D		Préparation
Sr 5	Utilisation des méthodes statistiques de vérification <i>Application of statistics in verification procedures</i>	D		Préparation
Sr 6	Exigences générales pour les instruments électroniques (revision D 11) <i>General requirements for electronic instruments</i>	D	2 AP	3 AP
SP 4	MESURES DE LONGUEURS, SURFACES, ANGLES <i>MEASUREMENT OF LENGTH, AREA, ANGLE</i>			
Sr 1	Mesures à traits de haute précision <i>High precision line measures of length</i>	R	P	CIML
	Calibres à bouts plans (revision R 30) <i>End measures of length</i>	R	P	Vote CIML
Sr 4	Schéma de hiérarchie, mesures de longueur <i>Hierarchy scheme for length measuring instruments</i>	D	Etude SP	P, Vote CIML
Sr 5	Schéma de hiérarchie, mesures d'angle <i>Hierarchy scheme for angle measuring instruments</i>	D	Etude SP	P
Sr 6	Appareils de mesure de la superficie des peaux <i>Instruments measuring the area of hides</i>	R	3 AP	4 AP
Sr 7	Terminologie utilisée en métrologie dimensionnelle <i>Terminology used in dimensional metrology</i>	D	Etude Sr	P
SP 5S	MESURE STATIQUE DES QUANTITES DE LIQUIDES <i>STATIC MEASUREMENT OF QUANTITIES OF LIQUIDS</i>			
Sr 2	Schémas de hiérarchie <i>Hierarchy schemes</i>	D	P	Etude SP
Sr 3	Pipettes automatiques en verre <i>Glass delivery measures (Automatic pipettes)</i>	R	P	Etude SP
Sr 5	Bouteilles récipients-mesures <i>Measuring container bottles</i>	R 96	CIML	
Sr 9	Installations pour le jaugeage des camions et wagons citernes <i>Calibration equipment for road and rail tankers</i>	D	Préparation	1 AP

Secrétariat	Titres abrégés des sujets <i>Short-form titles of subjects</i>	Forme de publication <i>Status</i>	Etat de préparation <i>Stage of preparation</i>	
			1989	1990
SP 5S	MESURE STATIQUE DES QUANTITES DE LIQUIDES (suite)			
Sr 10	Citernes de bateaux <i>Ship tanks</i>	R 95	CIML	
Sr 12	Mesurage statique de masses de liquides <i>Static direct mass measurement of liquids</i>	R	1 AP	2 AP
SP 5D	MESURE DYNAMIQUE DES QUANTITES DE LIQUIDES <i>DYNAMIC MEASUREMENT OF QUANTITIES OF LIQUIDS</i>			
Sr 1	Ensembles de mesurage de liquides autres que l'eau (compilation) <i>Measuring assemblies for liquids other than water (compilation)</i>	R	1 AP	2 AP
Sr 3	Compteurs d'eau froide (revision R 49) <i>Cold water meters</i>	R 49	2 AP	Etude Sr
Sr 6	Dispositifs électroniques des ensembles de mesure de liquides <i>Electronic devices in measuring assemblies for liquids</i>	R	1 P	Englobé dans Sr 1 <i>Included in Sr 1</i>
Sr 7	Etalons de volume utilisés pour la vérification des ensembles de mesure <i>Standard volume measures used for verification of measuring assemblies</i>	R	P	Etude SP
	Tubes étalons utilisés pour la vérification des ensembles de mesure <i>Pipe provers used for verification of measuring assemblies</i>	R	2 AP	3 AP
	Méthodes d'essai de compteurs routiers de carburant liquide <i>Testing procedures for liquid fuel dispensers</i>	D	2 AP	3 AP
Sr 8	Compteurs électromagnétiques <i>Electromagnetic meters</i>	R	1 AP	2 AP
Sr 9	Compteurs vortex <i>Vortex meters</i>	R	1 AP	2 AP
Sr 10	Compteurs massiques <i>Direct mass-flow measuring instruments</i>	R	2 AP	Etude Sr
SP 6	MESURE DES GAZ <i>MEASUREMENT OF GAS</i>			
Sr 2	Complément à R 32 "Compteurs de volume de gaz à pistons rotatifs" <i>Additions to R 32 "Rotary piston gas meters"</i>	R 32	1 AP	2 AP
Sr 3	Voludéprimomètres pour gaz <i>Differential pressure meters</i>	R	Préparation	1 AP

Secrétariat	Titres abrégés des sujets <i>Short-form titles of subjects</i>	Forme de publication <i>Status</i>	Etat de préparation <i>Stage of preparation</i>	
			1989	1990
SP 6	MESURE DES GAZ (suite)			
Sr 4	Mesure des hydrocarbures gazeux distribués par pipeline <i>Measurement of hydrocarbon gases distributed by pipeline</i>	D	2 AP	3 AP
Sr 9	Correcteurs de volume de gaz <i>Correctors of gas volumes</i>	R	Préparation	1 AP
SP 7	MESURE DES MASSES <i>MEASUREMENT OF MASS</i>			
Sr 2	Instruments de pesage électroniques <i>Electronic weighing instruments (revision R 74)</i>	R 74	Préparation	1 AP
Sr 4	Instruments de pesage non automatiques (révision R 76) <i>Non-automatic weighing instruments (revision R 76)</i>	R 76	1 AP	2 AP
Sr 5	Instruments de pesage totalisateurs discontinus <i>Discontinuous totalising weighing machines</i>	R	P	Vote CIML
	Ponts-bascules ferroviaires à fonctionnement automatique <i>Automatic rail-weighbridges</i>	R	P	Vote CIML
	Instruments de pesage totalisateurs continus (révision R 50) <i>Continuous totalising weighing machines</i>	R 50	3 AP	P
	Trieuses pondérales (révision R 51) <i>Checkweighing instruments</i>	R 51	1 AP	P
	Doseuses pondérales (révision R 61) <i>Gravimetric filling instruments</i>	R 61	2 AP	P
Sr 8	Réglementation métrologique des cellules de pesée (révision R 60) <i>Metrological regulations for load cells</i>	R 60	Vote CIML	CIML
SP 8	POIDS <i>WEIGHTS</i>			
Sr 1	Spécifications métrologiques pour les poids (compilation) <i>Metrological specifications for weights (compilation)</i>	D	1 AP	2 AP
SP 9	MESURE DE MASSES VOLUMIQUES <i>MEASUREMENT OF DENSITY</i>			
Sr 3	Aréomètres pour usages spécifiques <i>Hydrometers for specific uses</i>	R	Etude SP	Etude SP
Sr 9	Terminologie <i>Terminology</i>	D	P	Etude SP

Secrétariat	Titres abrégés des sujets <i>Short-form titles of subjects</i>	Forme de publication <i>Status</i>	Etat de préparation <i>Stage of preparation</i>	
			1989	1990
SP 10	INSTRUMENTS DE MESURE POUR VEHICULES <i>MEASURING INSTRUMENTS FOR VEHICLES</i>			
Sr 2	Instruments de mesure de vitesse et distance dans les véhicules (revision R 55) <i>Speed and distance measuring instruments for vehicles</i>	R 55		1 AP
Sr 3	Taximètres (revision R 21, extension aux taximètres électroniques) <i>Taximeters</i>	R 21	Etude Sr	3 AP
SP 11	MESURE DES PRESSIONS <i>MEASUREMENT OF PRESSURE</i>			
Sr 2	Schémas de hiérarchie <i>Hierarchy schemes</i>	D	3 AP	4 AP
Sr 3	Manomètres à piston <i>Pressure balances</i>	R	Vote CIML	Etude SP
Sr 4	Manomètres pour pneumatiques (revision R 23) <i>Tyre pressure gauges</i>	R 23	P	Vote CIML
	Manomètres de référence à éléments élastiques <i>Reference manometers with elastic sensors</i>	R	P	
	Révision des R 17 et R 19 <i>Revision of R 17 and R 19</i>	R	P	CIML
	Caractéristiques des éléments récepteurs élastiques (revision R 53) <i>Characteristics of elastic sensing elements</i>	R		1 AP
Sr 5	Manomètres pour la pression artérielle (revision R 16) <i>Manometers for instruments measuring blood pressure</i>	R 16	2 AP	3 AP
Sr 7	Baromètres <i>Barometers</i>	R 97	CIML	
SP 12	MESURE DES TEMPERATURES ET DE L'ENERGIE CALORIFIQUE <i>MEASUREMENT OF TEMPERATURE AND HEAT</i>			
Sr 3	Thermomètres à résistance de semi-conducteur <i>Semiconductor resistance thermometers</i>	R	1 AP	2 AP
Sr 5	Thermocouples, tables de f.e.m. et tolérances <i>Thermocouples, tables of EMF and tolerances</i>	R	Préparation	2 AP
Sr 6	Pyromètres à radiation totale <i>Total radiation pyrometers</i>	R		Vote CIML
	Lampes à ruban de tungstène pour l'étalonnage de pyromètres optiques (revision R 48) <i>Tungsten ribbon lamps for calibration of optical pyrometers</i>	R 48	2 AP	P

Secrétariat	Titres abrégés des sujets <i>Short-form titles of subjects</i>	Forme de publication <i>Status</i>	Etat de préparation <i>Stage of preparation</i>	
			1989	1990
SP 12	MESURE DES TEMPERATURES (suite)			
Sr 7	Thermomètres électriques médicaux à maximum <i>Clinical electrical thermometers with maximum device</i>	R	1 P	2 P
	Thermomètres électriques médicaux pour mesures continues <i>Clinical electrical thermometers for continuous measurement</i>	R	1 P	2 P
Sr 9	Méthodes de vérification des thermocouples étalons <i>Methods for verification of reference and ordinary thermocouples</i>	R	Etude SP	Vote CIML
SP 13	MESURES ELECTRIQUES ET MAGNETIQUES <i>MEASUREMENT OF ELECTRICAL AND MAGNETIC QUANTITIES</i>			
Sr 3	Compteurs d'énergie électrique active (revision R 46) <i>Active electrical energy meters</i>	R 46	Préparation	1 AP
SP 14	ACOUSTIQUE ET VIBRATIONS <i>ACOUSTICS AND VIBRATION</i>			
Sr 1	Sources sonores de référence <i>Sound calibrators</i>	R	Préparation	3 AP
	Filtres de bandes d'octave <i>Octave filters</i>	R	Préparation	1 AP
Sr 2	Audiomètres à son pur <i>Pure tone audiometers</i>	R	2 AP	P
Sr 3	Instruments de mesure de vibrations <i>Measuring instruments for response to vibration</i>	R	1 AP	2 AP
SP 15	OPTIQUE <i>OPTICS</i>			
Sr 2	Illuminancemètres <i>Illuminancemeters</i>	R	Préparation	2 AP
SP 17	MESURE DES POLLUTIONS <i>MEASUREMENT OF POLLUTION</i>			
Sr 1	Instruments de mesure des gaz d'échappement <i>Exhaust emission measuring instruments</i>	R	3 P	Vote CIML
Sr 2	Spectrophotomètres à absorption atomique pour la mesure des polluants métalliques dans l'eau <i>Atomic absorption spectrometers for measuring metal pollutants in water</i>	R	P	Vote CIML

Secrétariat	Titres abrégés des sujets <i>Short-form titles of subjects</i>	Forme de publication <i>Status</i>	Etat de préparation <i>Stage of preparation</i>	
			1989	1990
SP 17	MESURE DES POLLUTIONS (suite)			
	Spectromètres à plasma couplés inductivement <i>Inductively coupled plasma emission spectrometers</i>	R	1 AP	2 AP
Sr 4	Chromatographes à phase liquide de hautes performances pour la mesure de pesticides et autres substances toxiques <i>High performance liquid chromatographs for measuring pesticide and toxic substances pollution (HPLC)</i>	R	3 AP	P
Sr 5	Instruments portables pour la mesure des polluants de l'air provenant des déchets dangereux <i>Portable instruments for assessing airborne pollutants arising from hazardous wastes</i>	D	P	Vote CIML
	Chromatographes en phase gazeuse portatifs pour polluants gazeux <i>Portable gas chromatographs for gaseous pollutants</i>	R	1 AP	2 AP
SP 18	MESURE DES CARACTERISTIQUES DES PRODUITS ALIMENTAIRES <i>MEASUREMENT OF CHARACTERISTICS OF FOOD PRODUCTS</i>			
Sr 6	Réfractomètres pour la mesure de la teneur en sucre des moûts de raisin <i>Refractometers for the measurement of the sugar content of grape musts</i>	R	Préparation	2 AP
SP 19	MESURE DES CARACTERISTIQUES DES MATERIAUX <i>MEASUREMENT OF CHARACTERISTICS OF MATERIALS</i>			
Sr 4	Intercomparaison des étalons de dureté <i>Intercomparison of hardness standards</i>		Comparaisons	Comparaisons
SP 20	PRODUITS PREEMBALLEES <i>PREPACKAGED PRODUCTS</i>			
Sr 1	Poids égoutté des produits préemballés <i>Drained weight in packaged foods</i>	R	1 AP	Etude Sr
SP 21	NORMALISATION DES CARACTERISTIQUES METROLOGIQUES DES INSTRUMENTS DE MESURE <i>METROLOGICAL CHARACTERISTICS OF MEASURING INSTRUMENTS</i>			
Sr 6	Certification métrologique des systèmes de mesure <i>Metrological certification of measuring systems</i>	D	2 AP	3 AP

Secrétariat	Titres abrégés des sujets <i>Short-form titles of subjects</i>	Forme de publication <i>Status</i>	Etat de préparation <i>Stage of preparation</i>	
			1989	1990
SP 22	PRINCIPES DU CONTROLE METROLOGIQUE PRINCIPLES OF METROLOGICAL CONTROL			
Sr 4	Méthodes d'assurance de qualité appliquées dans le contrôle métrologique <i>Quality assurance methods applied to metrological controls</i>	D	Préparation	1 AP
Sr 5	Expertise métrologique <i>Metrological expertise</i>	D	2 AP	3 AP
SP 23	METHODES ET MOYENS D'ATTESTATION DES DISPOSITIFS DE VERIFICATION METHODS AND MEANS USED FOR CERTIFICATION OF VERIFICATION DEVICES			
Sr 1	Principes du choix et de l'expression des caractéristiques métrologiques des étalons <i>Principles for the selection and expression of metrological characteristics of measurement standards</i>	D	1 AP	2 AP
Sr 4	Principes du contrôle métrologique des dispositifs de vérification <i>Principles for metrological control of devices used for verification</i>	D		Vote CIML
Sr 7	Détermination des intervalles de réétalonnage <i>Determination of recalibration intervals</i>	D	Préparation	1 AP
SP 26	INSTRUMENTS DE MESURE UTILISES DANS LE DOMAINE DE LA SANTE MEASURING INSTRUMENTS USED IN THE FIELD OF HEALTH			
Sr 4	Electrocardioscopes (Appendice 1)	R 90	P	Etude SP
	Electrocardioscopes et électrocardiographes numériques (Appendice 2) <i>Digital electrocardioscopes and electrocardiographs</i>	R 90	P	Etude SP
	Représentation des caractéristiques des instruments de mesure bio-médicaux <i>Presentation of metrological characteristics of bio-electrical measuring instruments</i>	D	P	Etude SP
	Electrodes pour cardiographes et encéphalographes <i>Electrodes for cardiographs and encephalographs</i>	R	P	Etude SP
Sr 6	Ergomètres <i>Ergometers</i>	R	Préparation	1 AP
Sr 7	Instruments de mesure pour laboratoires médicaux <i>Measuring instruments for medical laboratories</i>	D	Préparation	1 AP

Secrétariat	Titres abrégés des sujets <i>Short-form titles of subjects</i>	Forme de publication <i>Status</i>	Etat de préparation <i>Stage of preparation</i>	
			1989	1990
SP 27	<p>PRINCIPES GENERAUX D'UTILISATION DES MATERIAUX DE REFERENCE <i>GENERAL PRINCIPLES FOR THE USE OF REFERENCE MATERIALS</i></p> <p>(Informations données sous réserve. Réévaluation des projets de travail en cours. <i>Information subject to possible modifications. Work plans under reevaluation</i>)</p>			
Sr 3	<p>Méthodes d'essai d'homogénéité des matériaux de référence poudreux et solides certifiés <i>Methods of testing the homogeneity of powdered and solid certified reference materials</i></p>	D	1 P	2 P
Sr 4	<p>Principes généraux et statistiques des méthodes de la certification des matériaux de référence <i>General and statistical principles of methods for certification of reference materials</i></p>	D	1 AP	2 AP
Sr 5	<p>Evaluation des méthodes de mesure pour la composition d'échantillons de substance <i>Assessment of measurement procedures for the composition of substance samples</i></p> <p>Utilisation des matériaux de référence certifiés pour l'étalonnage des spectrophotomètres <i>Use of certified reference materials for spectrophotometer calibration</i></p>	D R	3 AP 3 AP	P P
SP 30	<p>MESURES PHYSICO-CHIMIQUES <i>PHYSICO-CHEMICAL MEASUREMENTS</i></p> <p>(Informations données sous réserve. Réévaluation des projets de travail en cours. <i>Information subject to possible modifications. Work plans under reevaluation</i>)</p>			
Sr 1	<p>Echelle de pH des solutions aqueuses (revision R 54) <i>pH scale for aqueous solutions</i></p> <p>pH-métrie et ionométrie. Méthodes de mesurage <i>pH and ion measurements. Measuring methods</i></p> <p>Méthode de vérification des pH-mètres <i>Verification method of pH-meters</i></p> <p>Solutions pour la vérification des pH-mètres <i>Solutions for the verification of pH-meters</i></p>	R R R R	Etude SP 1 P 1 AP 1 AP	P 2 P 2 AP 2 AP
Sr 2	<p>Méthodes de mesure de la conductivité des électrolytes <i>Methods of conductivity measurement of electrolytic solutions</i></p> <p>Schéma de hiérarchie en conductométrie <i>Hierarchy scheme of conductometry</i></p>	R D	P 1 P	Etude SP Etude SP

Secrétariat	Titres abrégés des sujets <i>Short-form titles of subjects</i>	Forme de publication <i>Status</i>	Etat de préparation <i>Stage of preparation</i>	
			1989	1990
SP 30	MESURES PHYSICO-CHIMIQUES (suite)			
	Solutions-étalons de conductivité (revision R 56) <i>Standard solutions for conductivity</i>	R 56		Préparation
	Etalonnage des cellules de conductivité (revision R 68) <i>Calibration of conductivity cells</i>	R 68	Préparation	1 AP
	Solutions pour la vérification de conductomètres <i>Solutions for the verification of conductometers</i>	R		Préparation
Sr 3	Echelle d'humidité relative de l'air utilisant des solutions salines saturées <i>Scale of relative humidity of air using saturated salt solutions</i>	R	Etude SP	Etude SP
Sr 4	Vérification des dispositifs thermogravimétriques pour la mesure de l'humidité des solides <i>Verification of thermogravimetric devices for measuring the moisture content of solids</i>	R	Etude SP	P
	Humidimètres pour solides <i>Moisture meters of solid substances</i>	R	1 AP	2 AP
	Humidimètres capacitifs <i>Capacitive moisture meters</i>	R	1 AP	2 AP
Sr 6	Schéma de hiérarchie des instruments de mesure de l'humidité des gaz <i>Hierarchy scheme for instruments measuring the humidity of gases</i>	D	5 AP	P
	Méthodes et moyens d'essai des psychromètres <i>Methods and means for testing psychrometers</i>	R	3 AP	P
	Définitions de l'hygrométrie des gaz <i>Definitions in the hygrometry of gases</i>	D	1 AP	2 AP
Sr 9	Liquides étalons pour l'étalonnage de viscosimètres <i>Standard liquids used for the calibration of viscometers</i>	R	3 P	Etude SP
	Viscosimètres à bille. Méthodes d'étalonnage <i>Falling-ball viscometer. Calibration methods</i>	R	1 P	2 P
	Mesure de viscosité cinématique par viscosimètre étalon <i>Measurement of kinematic viscosity by a standard viscometer</i>	R	1 AP	2 AP
Sr 10	Méthodes et moyens pour la vérification des instruments de mesure de la teneur pondérale des polluants dans l'air <i>Methods and means for the verification of instruments measuring the mass concentration of pollutants in air</i>	R	1 P	2 P
	Erreurs des analyseurs de gaz (revision R 70) <i>Errors of gas analysers</i>	R 70	1 AP	2 AP
Sr 12	Explosimètres <i>Explosimeters</i>	R	2 AP	Etude Sr

Secrétariat	Titres abrégés des sujets <i>Short-form titles of subjects</i>	Forme de publication <i>Status</i>	Etat de préparation <i>Stage of preparation</i>	
			1989	1990
SP 30	MESURES PHYSICO-CHIMIQUES (suite)			
Sr 13	Ethylomètres <i>Breath testers</i>	R	Etude Sr	Etude Sr
SP 31	ENSEIGNEMENT DE LA METROLOGIE <i>TEACHING OF METROLOGY</i>			
Sr 1	Programme des cours de mesures mécaniques <i>Programme of the mechanical measurement course</i>	D	P	Etude SP
	Programme des cours de mesures électriques <i>Programme of the electrical measurement course</i>	D	2 AP, P	Etude SP
	Programme des cours de mesures thermiques <i>Programme of the thermotechnical measurement course</i>	D	1 AP	2 AP
	Programme des cours de mesures physico-chimiques <i>Programme of the physico-chemical measurement course</i>	D		1 AP

INFORMATIONS

NOUVEAUX PAYS MEMBRES

L'ARABIE SAOUDITE a adhéré à l'Organisation en qualité d'Etat membre. En attendant la désignation de son représentant au CIML, la correspondance est entretenue avec l'administration compétente: Saudi Arabian Standards Organization à Riyadh.

La LIBYE est devenue Membre Correspondant de l'OIML.

MEMBRES DU CIML

AUTRICHE — Monsieur R. LEWISCH a pris sa retraite et cessé de représenter son pays au CIML. Son successeur devrait être nommé prochainement.

POLOGNE — Le Gouvernement vient de désigner Monsieur Janusz MACIEJEWICZ, Président du Comité Polonais de Normalisation, de Mesures, et du Contrôle de la Qualité, pour représenter la Pologne au CIML.

URSS

Comme suite à une réorganisation du Gosstandart (dont le nouveau nom est Comité d'Etat pour le contrôle de la qualité des produits et la normalisation), le Représentant de l'URSS auprès du Comité International de Métrologie Légale est maintenant Monsieur le Professeur V.I. PUSTOVOIT, Vice-Président, qui remplace Dr A.I. MEKHANNIKOV, appelé à d'autres fonctions.

Nous rappelons à cette occasion que le Président du Gosstandart est depuis le milieu de l'année 1989 Monsieur V.V. SYTCHEV; par ailleurs l'ancien Département de Métrologie du Gosstandart est devenu Division de Métrologie Légale et son Chef est Monsieur V.I. BELOTSERKOVSKI.

ETATS-UNIS D'AMERIQUE

Le National Institute of Standards and Technology (NIST) vient de publier un annuaire de 235 pages sur les laboratoires et associations privés des Etats-Unis effectuant des certifications de divers produits: Directory of U.S. Private Sector Product Certification Programs, NIST Special Publication 774, December 1989. Cette publication peut être obtenue en s'adressant au Superintendent of Documents, US Government Printing Office, Washington D.C. 20402.

FRANCE

Un colloque international est organisé par RILEM et ILAC du 15 au 17 octobre 1990 au Domaine de Saint-Paul, Saint-Rémy-les-Chevreuse, près de Paris, sur le thème

“Qualité des essais et assurance de la qualité des laboratoires d'essais pour les matériaux de construction et les ouvrages”.

Bien qu'en principe axé sur les problèmes d'essai de matériaux de construction, ce colloque traitera en grande partie des problèmes généraux de mise en pratique de la qualité dans les laboratoires d'essais ainsi que des coopérations internationales et régionales dans ce domaine.

Le colloque se tiendra sous le co-patronage de ASTM, CEN, ISO et OIML.

POLOGNE

Le Comité polonais de normalisation, des mesures et de contrôle de la qualité (PKNiM) nous informe que les publications suivantes relatives à la métrologie ont été publiées en langue polonaise ces dernières années aux Editions de Normalisation "ALFA":

Guides pour agents de vérification

- J. Gliwinski: Legalizacja narzedzi do pomiaru dlugosci i kata
(Vérification et poinçonnage des instruments de mesure de longueur et angle), 152 pages, 1986
- J. Mikoszewski: Twardosciomierze
(Machines d'essai de dureté), 91 pages, 1987
- A. Gizmajer: Pomiary sily
(Mesures des forces), 105 pages, 1987
- B. Piotrowska,
H. Durlik,
H. Kwiatkowska: Wagi duzej dokladnosci. Odwazniki
(Instruments de pesage de haute précision. Poids-étalons), 244 pages, 1988
- K. Kacprzak: Wagi handlowe i przemyslowe
(Instruments de pesage du commerce et de l'industrie), 95 pages, 1987
- J. Mikoszewski: Maszyny wytrzymaosciowe
(Machines d'essai des matériaux), 177 pages, 1988

Manuels

- B. Piotrowska: Odwazniki. Przepisy i komentarze
(Poids. Règlements et commentaires), 212 pages, 1986
- K. Kacprzak: Wagi. Przepisy i komentarze
(Instruments de pesage. Règlements et commentaires), 295 pages, 1986

ROYAUME-UNI

Le laboratoire national des poids et mesures (NWML) a commencé à éditer une revue d'informations dont le but principal est de donner des nouvelles des activités de l'OIML ainsi que d'autres organisations internationales et européennes s'occupant des aspects de la métrologie légale ou pratique. Cette revue "International Scene" dont deux numéros ont déjà paru, peut être obtenue en s'adressant à:

International Section
National Weights and Measures Laboratory
Stanton Avenue
Teddington, Middlesex TW11 OJZ

ASMO

Les activités de l'Organisation Arabe de Normalisation et de Métrologie dont le siège était installé à Amman, viennent d'être incorporées à celles de l'Organisation Arabe pour le Développement Industriel, dont le siège est à Bagdad. Les nouvelles appellation et adresse sont:

Arab Organization for Industrial Development
Standardization and Metrology Center
P.O. Box 3156
Baghdad — Saadoun
Iraq

BIPM

Nous avons le grand plaisir d'informer nos lecteurs que, au cours d'une cérémonie qui s'est déroulée au Bureau International des Poids et Mesures le vendredi 23 mars 1990, Monsieur CURIEN, Ministre de la Recherche et de la Technologie de la République française, a remis la Croix de Chevalier dans l'Ordre National de la Légion d'Honneur à Monsieur Pierre GIACOMO, Directeur Honoraire du Bureau International.

Le BIML adresse, en cette occasion, ses très sincères félicitations à Monsieur GIACOMO.

CIE

La Commission Internationale de l'Eclairage (CIE) a récemment fait paraître un rapport technique sur la mesure des flux lumineux, qui peut sans doute intéresser un grand nombre de laboratoires s'occupant de métrologie légale ou pratique dans ce domaine.

Cette publication CIE n° 84 "Measurement of luminous flux" traite la terminologie, les principes de base des mesures de flux lumineux, les méthodes d'évaluation de la distribution de l'illuminance, les mesures faites en utilisant une sphère d'intégration ainsi que la détermination du flux lumineux par des mesures de luminance, d'intensité lumineuse et d'illuminance.

La CIE annonce d'autre part la tenue d'un séminaire sur les mesures photométriques à Vienne du 10 au 14 septembre 1990. La 22e session ou assemblée générale de la CIE doit se tenir à Melbourne, Australie du 2 au 11 juillet 1991.

Pour toutes informations sur ces manifestations et sur les publications de la CIE, s'adresser à la Commission nationale de la CIE de votre pays ou au Bureau Central de la CIE, Kegelgasse 27, 1030 Vienne, Autriche.

INFORMATION

NEW COUNTRY MEMBERS

SAUDI ARABIA has adhered to OIML as full Member State. Pending the designation of its CIML representative, correspondence is exchanged with the competent administration: Saudi Arabian Standards Organization in Riyadh.

LIBYA has become Corresponding Member of OIML.

CIML MEMBERS

AUSTRIA — Dr R. LEWISCH has retired and does no longer represent his country within CIML. His successor is expected to be nominated within a short time.

POLAND — The Government has designated to represent his country within CIML Mr Janusz MACIEJEWICZ, President of the Polish Committee of Standardization, Measures and Quality Control.

USSR

Following a restructuring of Gosstandart (for which the new name is USSR State Committee for Product Quality Control and Standards) the new USSR Member of CIML is Professor V.I. PUSTOVOIT, Vice-President of Gosstandart, in replacement of Dr A.I. MEKHANNIKOV who has taken up other duties.

We take the opportunity of reminding readers that the President of Gosstandart is since the middle of 1989 Mr V.V. SYTCHEV. The former Department of Metrology of Gosstandart has now become the Division of Legal Metrology and is directed by Mr V.I. BELOTSEKOVSKI.

U.S.A.

The National Institute of Standards and Technology (NIST) has recently issued a directory of 235 pages listing private laboratories and associations undertaking certification of various products in the United States: Directory of U.S. Private Sector Product Certification Programs, NIST Special Publication 774, December 1989 obtainable from Superintendent of Documents, U.S. Government Printing Office, Washington D.C. 20402.

FRANCE

An international symposium is organised by RILEM and ILAC, 15-17 October 1990 at Domaine de Saint-Paul, Saint-Rémy-les-Chevreuse near Paris on the subject

“Test quality and quality assurance in testing laboratories
for construction materials and structures”.

Though the seminar is mainly aimed at problems in testing building products it will largely discuss general problems of applying quality concepts in testing laboratories as well as international and regional cooperation in this field. The symposium is co-sponsored by ASTM, CEN, ISO and OIML.

POLAND

The Polish Committee for Standardization, Measures and Quality Control (PKNMiJ) informs that the following publications in the field of metrology have been published in recent years in Polish language by the standardization publisher "ALFA":

Guides for verification officers

- J. Gliwinski: Legalizacja narzedzi do pomiaru dlugosci i kata
(Verification and stamping of length and angle measuring instruments), 152 pages, 1986
- J. Mikoszewski: Twardosciomierze
(Hardness testing instruments), 91 pages, 1987
- A. Gizmajer: Pomiary sily
(Force measurements), 105 pages, 1987
- B. Piotrowska,
H. Durlik,
H. Kwiatkowska: Wagi duzej dokladnosci. Odwazniki
(Weighing instruments with high accuracy - Standard weights),
244 pages, 1988
- K. Kacprzak: Wagi handlowe i przemyslowe
(Weighing instruments for trade and industry), 95 pages, 1987
- J. Mikoszewski: Maszyny wytrzymaosciowe
(Material testing machines), 177 pages, 1988

Handbooks

- B. Piotrowska: Odwazniki. Przepisy i komentarze
(Weights. Regulations and comments), 212 pages, 1986
- K. Kacprzak: Wagi. Przepisy i komentarze
(Weighing instruments. Regulations and comments), 295 pages, 1986

UNITED KINGDOM

The National Weights and Measures Laboratory has started to publish newsletters with the main scope of informing about the activities of OIML and other International or European Organisations dealing with legal or practical metrology. This newsletter of which the two first numbers have already been issued is called "International scene" and may be obtained from the

International Section
National Weights and Measures Laboratory
Stanton Avenue
Teddington, Middlesex TW11 OJZ

ASMO

The activities of the Arab Organization for Standardization and Metrology which had its head office in Amman, have now been incorporated into the Arab Organization for Industrial Development which has its office in Baghdad. The new name and address are:

Arab Organization for Industrial Development
Standardization and Metrology Center
P.O. Box 3156
Baghdad — Saadoun
Iraq

BIPM

It is with great pleasure that we inform our readers that, during a ceremony at the International Bureau of Weights and Measures, Monsieur CURIEN, Minister of Research and Technology of the French Republic, invested Monsieur Pierre GIACOMO, Honorary Director of the International Bureau, with the Knight's Cross of the National Order of the Legion of Honour.

The BIPM offers its most sincere congratulations to Monsieur GIACOMO on this occasion.

CIE

The International Commission on Illumination has recently published a technical report on the measurement of luminous flux which is no doubt of interest to many laboratories dealing with legal or practical metrology in this field.

This publication CIE No. 84 "Measurement of luminous flux" defines the terminology required for luminous flux measurements. It then deals with the principles of luminous flux measurements and describes methods for the evaluation of the illuminance distribution, the measurement of luminous flux by means of an integrating sphere photometer and the determination of luminous flux via luminance, luminous intensity and illuminance measurements.

The CIE has also announced a seminar on light measurement to be held at its Central Bureau in Vienna, Austria 10-14 September 1990. The 22nd session of the CIE will be held in Melbourne, Australia 2-11 July 1991.

Information on these events and on CIE publications can be supplied by the national commission to CIE of your country or by the CIE Central Bureau, Kegelgasse 27, 1030 Vienna, Austria.

REUNIONS OIML

	Groupes de travail	Dates	Lieux
SP 14 + Sr	Acoustique et vibrations <i>Acoustics and vibration</i>	3-4 Mai/May 1990	BIML, PARIS
SP 7-Sr 5	Instruments de pesage à fonctionnement automatique <i>Automatic weighing instruments</i>	7-11 Mai/May 1990	TEDDINGTON ROYAUME-UNI
SP 12-Sr 7	Thermomètres médicaux <i>Clinical thermometers</i>	8-11 Mai/May 1990	LUDWIGSHAFEN R.F. d'ALLEMAGNE
SP 17 + Sr 1, 4, 5	Mesure des pollutions <i>Measurement of pollution</i>	14-17 Mai/May 1990	BERLIN-OUEST WEST-BERLIN
SP 7-Sr 4	Instruments de pesage à fonctionnement non automatique <i>Non-automatic weighing instruments</i>	21-23 Mai/May 1990	BRAUNSCHWEIG R.F. d'ALLEMAGNE
SP 20 + Sr	Produits préemballés <i>Prepackaged products</i>	} 11-15 Juin/June 1990	WABERN SUISSE
SP 2-Sr 5	Contrôle par échantillonnage <i>Control by sampling</i>		
SP 7-Sr 2	Masses. Problèmes généraux. Dispositifs électroniques <i>Mass. General problems. Electronic devices</i>	16-19 Juil./July 1990 (provisoire/provisional)	WASHINGTON U.S.A.
SP 8-Sr 5	Poids utilisés dans le commerce et l'industrie <i>Weights used in trade and industry</i>	} Juillet/July 1990 (provisoire/provisional)	WASHINGTON U.S.A.
SP 8-Sr 6	Poids de précision <i>Weights of high accuracy</i>		
SP 5D-Sr 3	Compteurs d'eau <i>Water meters</i>	11-12 Oct./October 1990	BERLIN-OUEST WEST-BERLIN
SP 5D	Mesurage dynamique des quantités de liquides <i>Dynamic measurement of quantities of liquids</i>	} 22-26 Oct./October 1990	WASHINGTON U.S.A.
SP 5D-Sr 1	Compteurs et ensembles de mesure de liquides autres que l'eau à chambres mesureuses ou à turbine <i>Meters and measuring systems for liquids other than water with measuring chambers or with turbines</i>		
SP 5D-Sr 10	Mesurage massique direct en dynamique des quantités de liquides <i>Mass flow assemblies for measuring quantities of liquids</i>		
SP 22-Sr 3	Principes de l'essai de modèle <i>Principles of pattern evaluation</i>	} Oct./October 1990 (provisoire/provisional)	BIML, PARIS
SP 22-Sr 4	Principes de la vérification des instruments <i>Principles of verification of instruments</i>		
Séminaire technique de l'OIML: Instruments de pesage électroniques <i>Electronic weighing instruments</i>		15-18 Mai/May 1990	BRAUNSCHWEIG R.F. d'ALLEMAGNE

Note: Liste à jour fin mars 1990
List as per end March 1990

PUBLICATIONS

- Vocabulaire de métrologie légale
Vocabulary of legal metrology
- Vocabulaire international des termes fondamentaux et généraux de métrologie
International vocabulary of basic and general terms in metrology

RECOMMANDATIONS INTERNATIONALES

INTERNATIONAL RECOMMENDATIONS

R N°

- 1 — Poids cylindriques de 1 g à 10 kg (de la classe de précision moyenne)
Cylindrical weights from 1 g to 10 kg (medium accuracy class)
- 2 — Poids parallélépipédiques de 5 à 50 kg (de la classe de précision moyenne)
Rectangular bar weights from 5 to 50 kg (medium accuracy class)
- 4 — Fioles jaugées (à un trait) en verre
Volumetric flasks (one mark) in glass
- 5 — Compteurs de liquides autres que l'eau à chambres mesureuses
Meters for liquids other than water with measuring chambers
- 6 — Dispositions générales pour les compteurs de volume de gaz
General provisions for gas volume meters
- 7 — Thermomètres médicaux (à mercure, en verre, avec dispositif à maximum)
Clinical thermometers (mercury-in-glass, with maximum device)
- 9 — Vérification et étalonnage des blocs de référence de dureté Brinell
Verification and calibration of Brinell hardness standardized blocks
- 10 — Vérification et étalonnage des blocs de référence de dureté Vickers
Verification and calibration of Vickers hardness standardized blocks
- 11 — Vérification et étalonnage des blocs de référence de dureté Rockwell B
Verification and calibration of Rockwell B hardness standardized blocks
- 12 — Vérification et étalonnage des blocs de référence de dureté Rockwell C
Verification and calibration of Rockwell C hardness standardized blocks
- 14 — Saccharimètres polarimétriques
Polarimetric saccharimeters
- 15 — Instruments de mesure de la masse à l'hectolitre des céréales
Instruments for measuring the hectolitre mass of cereals

- 16 — Manomètres des instruments de mesure de la tension artérielle (sphygmo-
manomètres)
Manometers for instruments for measuring blood pressure (sphygmomanometers)
- 17 — Manomètres, vacuomètres, manovacuumètres indicateurs
Indicating pressure gauges, vacuum gauges and pressure-vacuum gauges
- 18 — Pyromètres optiques à filament disparaissant
Visual disappearing filament pyrometers
- 19 — Manomètres, vacuomètres, manovacuumètres enregistreurs
Recording pressure gauges, vacuum gauges, and pressure-vacuum gauges
- 20 — Poids des classes de précision E_1 E_2 F_1 F_2 M_1 de 50 kg à 1 mg
Weights of accuracy classes E_1 E_2 F_1 F_2 M_1 from 50 kg to 1 mg
- 21 — Taximètres
Taximeters
- 22 — Tables alcoométriques internationales
International alcoholometric tables
- 23 — Manomètres pour pneumatiques de véhicules automobiles
Tyre pressure gauges for motor vehicles
- 24 — Mètre étalon rigide pour agents de vérification
Standard one metre bar for verification officers
- 25 — Poids étalons pour agents de vérification
Standard weights for verification officers
- 26 — Seringues médicales
Medical syringes
- 27 — Compteurs de volume de liquides (autres que l'eau). Dispositifs complémentaires
Volume meters for liquids (other than water). Ancillary equipment
- 29 — Mesures de capacité de service
Capacity serving measures
- 30 — Mesures de longueur à bouts plans (calibres à bouts plans ou cales-étalons)
End standards of length (gauge blocks)
- 31 — Compteurs de volume de gaz à parois déformables
Diaphragm gas meters
- 32 — Compteurs de volume de gaz à pistons rotatifs et compteurs de volume de
gaz à turbine
Rotary piston gas meters and turbine gas meters
- 33 — Valeur conventionnelle du résultat des pesées dans l'air
Conventional value of the result of weighing in air
- 34 — Classes de précision des instruments de mesurage
Accuracy classes of measuring instruments

- 35 — Mesures matérialisées de longueur pour usages généraux
Material measures of length for general use
- 36 — Vérification des pénétrateurs des machines d'essai de dureté
Verification of indenters for hardness testing machines
- 37 — Vérification des machines d'essai de dureté (système Brinell)
Verification of hardness testing machines (Brinell system)
- 38 — Vérification des machines d'essai de dureté (système Vickers)
Verification of hardness testing machines (Vickers system)
- 39 — Vérification des machines d'essai de dureté (systèmes Rockwell B, F, T - C, A, N)
Verification of hardness testing machines (Rockwell systems B, F, T - C, A, N)
- 40 — Pipettes graduées étalons pour agents de vérification
Standard graduated pipettes for verification officers
- 41 — Burettes étalons pour agents de vérification
Standard burettes for verification officers
- 42 — Poinçons de métal pour agents de vérification
Metal stamps for verification officers
- 43 — Fioles étalons graduées en verre pour agents de vérification
Standard graduated glass flasks for verification officers
- 44 — Alcoomètres et aréomètres pour alcool et thermomètres utilisés en alcoométrie
Alcoholometers and alcohol hydrometers and thermometers for use in alcoholometry
- 45 — Tonneaux et futailles
Casks and barrels
- 46 — Compteurs d'énergie électrique active à branchement direct (de la classe 2)
Active electrical energy meters for direct connection (class 2)
- 47 — Poids étalons pour le contrôle des instruments de pesage de portée élevée
Standard weights for testing of high capacity weighing machines
- 48 — Lampes à ruban de tungstène pour l'étalonnage des pyromètres optiques
Tungsten ribbon lamps for calibration of optical pyrometers
- 49 — Compteurs d'eau (destinés au mesurage de l'eau froide)
Water meters (intended for the metering of cold water)
- 50 — Instruments de pesage totalisateurs continus à fonctionnement automatique
Continuous totalising automatic weighing machines
- 51 — Trieuses pondérales de contrôle et trieuses pondérales de classement
Checkweighing and weight grading machines
- 52 — Poids hexagonaux. Classe de précision ordinaire de 100 g à 50 kg
Hexagonal weights. Ordinary accuracy class, from 100 g to 50 kg
- 53 — Caractéristiques métrologiques des éléments récepteurs élastiques utilisés pour le mesurage de la pression. Méthodes de leur détermination
Metrological characteristics of elastic sensing elements used for measurement of pressure. Determination methods
- 54 — Echelle de pH des solutions aqueuses
pH scale for aqueous solutions
- 55 — Compteurs de vitesse, compteurs mécaniques de distances et chronotachygraphes des véhicules automobiles - Réglementation métrologique
Speedometers, mechanical odometers and chronotachographs for motor vehicles. Metrological regulations

- 56 — Solutions-étalons reproduisant la conductivité des électrolytes
Standard solutions reproducing the conductivity of electrolytes
- 57 — Ensembles de mesurage de liquides autres que l'eau équipés de compteurs de volumes. Dispositions générales
Measuring assemblies for liquids other than water fitted with volume meters. General provisions
- 58 — Sonomètres
Sound level meters
- 59 — Humidimètres pour grains de céréales et graines oléagineuses
Moisture meters for cereal grains and oilseeds
- 60 — Réglementation métrologique des cellules de pesée
Metrological regulations for load cells
- 61 — Doseuses pondérales à fonctionnement automatique
Automatic gravimetric filling machines
- 62 — Caractéristiques de performance des extensomètres métalliques à résistance
Performance characteristics of metallic resistance strain gages
- 63 — Tables de mesure du pétrole
Petroleum measurement tables
- 64 — Exigences générales pour les machines d'essai des matériaux
General requirements for materials testing machines
- 65 — Exigences pour les machines d'essai des matériaux en traction et en compression
Requirements for machines for tension and compression testing of materials
- 66 — Instruments mesureurs de longueurs
Length measuring instruments
- 67 — Ensembles de mesurage de liquides autres que l'eau équipés de compteurs de volumes. Contrôles métrologiques
Measuring assemblies for liquids other than water fitted with volume meters. Metrological controls
- 68 — Méthode d'étalonnage des cellules de conductivité
Calibration method for conductivity cells
- 69 — Viscosimètres à capillaire, en verre, pour la mesure de la viscosité cinématique
Glass capillary viscometers for the measurement of kinematic viscosity
- 70 — Détermination des erreurs de base et d'hystérésis des analyseurs de gaz
Determination of intrinsic and hysteresis errors of gas analysers
- 71 — Réservoirs de stockage fixes. Prescriptions générales
Fixed storage tanks. General requirements
- 72 — Compteurs d'eau destinés au mesurage de l'eau chaude
Hot water meters
- 73 — Prescriptions pour les gaz purs CO, CO₂, CH₄, H₂, O₂, N₂ et Ar destinés à la préparation des mélanges de gaz de référence
Requirements concerning pure gases CO, CO₂, CH₄, H₂, O₂, N₂ and Ar intended for the preparation of reference gas mixtures

- 74 — Instruments de pesage électroniques
Electronic weighing instruments
- 75 — Compteurs d'énergie thermique
Heat meters
- 76 — Instruments de pesage à fonctionnement non automatique
Non-automatic weighing instruments
Partie 1 : Exigences métrologiques et techniques - Essais
Part 1: Metrological and technical requirements - Tests
Partie 2 : Rapport d'essai de modèle
Part 2: Pattern evaluation report
- 77 — Ensembles de mesurage de liquides autres que l'eau équipés de compteurs de volumes. Dispositions particulières relatives à certains ensembles
Measuring assemblies for liquids other than water fitted with volume meters. Provisions specific to particular assemblies
- 78 — Pipettes Westergren pour la mesure de la vitesse de sédimentation des hématies
Westergren tubes for measurement of erythrocyte sedimentation rate
- 79 — Etiquetage des préemballages
Information on package labels
- 80 — Camions et wagons-citernes
Road and rail tankers
- 81 — Dispositifs et systèmes de mesure de liquides cryogéniques (comprend tables de masse volumique pour argon, hélium, hydrogène, azote et oxygène liquides)
Measuring devices and measuring systems for cryogenic liquids (including tables of density for liquid argon, helium, hydrogen, nitrogen and oxygen)
- 82 — Chromatographes en phase gazeuse pour la mesure des pollutions par pesticides et autres substances toxiques
Gas chromatographs for measuring pollution from pesticides and other toxic substances
- 83 — Chromatographe en phase gazeuse équipé d'un spectromètre de masse et d'un système de traitement de données pour l'analyse des polluants organiques dans l'eau
Gas chromatograph/mass spectrometer/data system for analysis of organic pollutants in water
- 84 — Capteurs à résistance thermométrique de platine, de cuivre ou de nickel (à usages techniques et commerciaux)
Resistance-thermometer sensors made of platinum, copper or nickel (for industrial and commercial use)
- 85 — Jaugeurs automatiques pour le mesurage des niveaux de liquide dans les réservoirs de stockage fixes
Automatic level gauges for measuring the level of liquid in fixed storage tanks
- 86 — Compteurs à tambour pour alcool et leurs dispositifs complémentaires
Drum meters for alcohol and their supplementary devices
- 87 — Contenu net des préemballages
Net content in packages

- 88 — Sonomètres intégrateurs-moyenneurs
Integrating-averaging sound level meters
- 91 — Cinémomètres radar pour la mesure de la vitesse des véhicules
Radar equipment for the measurement of the speed of vehicles
- 92 — Humidimètres pour le bois — Méthodes et moyens de vérification: exigences générales
Wood-moisture meters - Verification methods and equipment: general provisions

DOCUMENTS INTERNATIONAUX

INTERNATIONAL DOCUMENTS

D N°

- 1 — Loi de métrologie
Law on metrology
- 2 — Unités de mesure légales
Legal units of measurement
- 3 — Qualification légale des instruments de mesurage
Legal qualification of measuring instruments
- 4 — Conditions d'installation et de stockage des compteurs d'eau froide
Installation and storage conditions for cold water meters
- 5 — Principes pour l'établissement des schémas de hiérarchie des instruments de mesure
Principles for the establishment of hierarchy schemes for measuring instruments
- 6 — Documentation pour les étalons et les dispositifs d'étalonnage
Documentation for measurement standards and calibration devices
- 7 — Evaluation des étalons de débitmétrie et des dispositifs utilisés pour l'essai des compteurs d'eau
The evaluation of flow standards and facilities used for testing water meters
- 8 — Principes concernant le choix, la reconnaissance officielle, l'utilisation et la conservation des étalons
Principles concerning choice, official recognition, use and conservation of measurement standards
- 9 — Principes de la surveillance métrologique
Principles of metrological supervision
- 10 — Conseils pour la détermination des intervalles de réétalonnage des équipements de mesure utilisés dans les laboratoires d'essais
Guidelines for the determination of recalibration intervals of measuring equipment used in testing laboratories
- 11 — Exigences générales pour les instruments de mesure électroniques
General requirements for electronic measuring instruments

- 12 — Domaines d'utilisation des instruments de mesure assujettis à la vérification
Fields of use of measuring instruments subject to verification
- 13 — Conseils pour les arrangements bi- ou multilatéraux de reconnaissance des :
résultats d'essais - approbations de modèles - vérifications
*Guidelines for bi- or multilateral arrangements on the recognition of : test results -
pattern approvals - verifications*
- 14 — Formation du personnel en métrologie légale - Qualification - Programmes
d'étude
Training of legal metrology personnel - Qualification - Training programmes
- 15 — Principes du choix des caractéristiques pour l'examen des instruments de
mesure usuels
Principles of selection of characteristics for the examination of measuring instruments
- 16 — Principes d'assurance du contrôle métrologique
Principles of assurance of metrological control
- 17 — Schéma de hiérarchie des instruments de mesure de la viscosité des liquides
Hierarchy scheme for instruments measuring the viscosity of liquids
- 18 — Principes généraux d'utilisation des matériaux de référence certifiés dans les
mesurages
General principles of the use of certified reference materials in measurements
- 19 — Essai de modèle et approbation de modèle
Pattern evaluation and pattern approval
- 20 — Vérifications primitive et ultérieure des instruments et processus de mesure
Initial and subsequent verification of measuring instruments and processes

Note — Ces publications peuvent être acquises au / *These publications may be purchased from*
Bureau International de Métrologie Légale, 11, rue Turgot, 75009 PARIS.



ORGANISATION INTERNATIONALE DE MÉTROLOGIE LÉGALE

ETATS MEMBRES

ALGERIE	INDONESIE
REP. FEDERALE D'ALLEMAGNE	IRLANDE
REP. DEMOCRATIQUE ALLEMANDE	ISRAEL
ARABIE SAOUDITE	ITALIE
AUSTRALIE	JAPON
AUTRICHE	KENYA
BELGIQUE	LIBAN
BRESIL	MAROC
BULGARIE	MONACO
CAMEROUN	NORVEGE
CANADA	PAKISTAN
REP. POP. DE CHINE	PAYS-BAS
CHYPRE	POLOGNE
REP. DE COREE	PORTUGAL
REP. POP. DEM. DE COREE	ROUMANIE
CUBA	ROYAUME-UNI DE GRANDE-BRETAGNE ET D'IRLANDE DU NORD
DANEMARK	SRI LANKA
EGYPTE	SUEDE
ESPAGNE	SUISSE
ETATS-UNIS D'AMERIQUE	TANZANIE
ETHIOPIE	TCHECOSLOVAQUIE
FINLANDE	TUNISIE
FRANCE	U.R.S.S.
GRECE	YOUgoslavie
HONGRIE	
INDE	

MEMBRES CORRESPONDANTS

Albanie - Bahrein - Bangladesh - Barbade - Botswana - Burkina Faso - Colombie - Costa Rica - Equateur
Fidji - Ghana - Hong Kong - Irak - Islande - Jordanie - Koweït - Libye - Luxembourg - Malaisie - Mali
Maurice - Mexique - Népal - Nouvelle-Zélande - Oman - Panama - Pérou - Philippines - Sénégal - Seychelles
Syrie - Trinité et Tobago - Turquie - Venezuela

MEMBRES

du

COMITE INTERNATIONAL de METROLOGIE LEGALE

ALGERIE

Membre à désigner par son Gouvernement
Correspondance adressée à
Office National de Métrologie Légale
1, rue Kaddour Rahim Hussein Dey
ALGER

REPUBLIQUE FEDERALE D'ALLEMAGNE

Mr M. KOCHSIEK
Directeur
Physikalisch-Technische Bundesanstalt,
Bundesallee 100 - Postfach 3345
3300 BRAUNSCHWEIG.
TP 49-531-592 80 10 TC 49-531-592 76 14
TX 9-52 822 PTB
TG Bundesphysik Braunschweig

REPUBLIQUE DEMOCRATIQUE ALLEMANDE

Mr K. HASCHÉ
Leiter der Fachabteilung "Mechanik/Metrologie
in der Fertigungstechnik"
Amt für Standardisierung, Messwesen,
und Warenprüfung,
Fürstenwalder Damm 388
1162 BERLIN.
TP 37-2-65 260
TX 112630 asmw

ARABIE SAOUDITE

Membre à désigner par son Gouvernement
Correspondance adressée à:
The General Director
Saudi Arabian Standards Organization
P.O. Box 3437
11471 RIYADH

AUSTRALIE

Mr J. BIRCH
Executive Director
National Standards Commission,
P.O. Box 282
NORTH RYDE, N.S.W. 2113.
TP 61-2-888 39 22 TC 61-2-888 30 33
TX AA 23144
TG NATSTANCOM Sydney

AUTRICHE

Membre à désigner par son Gouvernement
Correspondance adressée à:
Metrology Service
Bundesamt für Eich- und Vermessungswesen
Postfach 20
Arltgassee 35
A-1163 WIEN.
TP 43-222-92 16 27 TC 43-222-92 44 65
TX 115 468 bevwn

BELGIQUE

Mr H. VOORHOF
Inspecteur Général
Service de la Métrologie
24-26, rue J.A. De Mot
B-1040 BRUXELLES
TP 32-2-233 61 11 TC 32-2-230 83 00
TX 20 627 COM HAN

BRESIL

Mr MASAO ITO
Président, INMETRO
Praça Mauah N° 7, 13 Andar
20081 RIO DE JANEIRO
TP 55-21-233 1586 et 233 1184
TX 2134599 IMNQ BR

BULGARIE

Mr V. TZAREVSKI
Vice-Président
Comité de la Qualité auprès du Conseil des
Ministres de la R.P. de Bulgarie
21, rue du 6 Septembre
1000 SOFIA
TP 359-2-8591
TX 22 570 DKS BG
TG techprogress

CAMEROUN

Mr E. NDOUGOU
Sous-Directeur des Poids et Mesures
Direction des Prix, Poids et Mesures
Ministère du Développement Industriel
et Commercial
B.P. 501
YAOUNDE
TP 237-22 35 69
TX 82-68 à Yaoundé

CANADA

Mr R.G. KNAPP
Director, Legal Metrology Branch
Consumer and Corporate Affairs
207, rue Queen
OTTAWA, Ontario K1A 0C9
TP 1-613-952 0655
TX 053 3694

REPUBLIQUE POPULAIRE DE CHINE

Mr BAI JINGZHONG
Deputy Director General
State Bureau of Technical Supervision
P.O. Box 2112
BEIJING
TP 86-1-44 43 04
TX 210209 SBTS CN
TG 1918 Beijing

CHYPRE

Mr G. TSIARTZAZIS
Controller of Weights and Measures
Ministry of Commerce and Industry
NICOSIA
TP 357(2) 40 34 41 - 48 TC 357(2) 36 61 20
TX 2283 MIN COMIND
TG Mincommind Nicosia

REPUBLIQUE DE COREE

Mr SON BOCK-GILL
Director of Metrology Division
Bureau of Standards
Industrial Advancement Administration
2, Chung-and-dong,
KWACH'ON, KYONGGI-DO 171-11
TP 82-2-590 89 90
TG KORIAA.

REPUBLIQUE POP. DEM. DE COREE

Mr DJEUNG KI TCHEUL
Directeur de l'Institut Central de Qualité
et de Métrologie auprès du Comité National
de la Science et de la Technologie
Arrondissement de Sadong
PYONGYANG
TG standard

CUBA

Membre à désigner par son Gouvernement
Correspondance adressée à :
Mr Acosta Alemany
Comite Estatal de Normalizacion
Egido 610 e/Gloria and Apodaca
HABANA Vieja
TP 7-67901 et 619587
TX 512236 CENDH
TG CEN HAVANA

DANEMARK

Mr Ove E. PETERSEN
Senior Executive Engineer
Division of Metrology
National Agency of Industry and Trade
Tagensvej 135
DK-2200 COPENHAGEN N
TP 45-31-85 10 66 TC 45-1-81 70 68
TX 15768 INDTRA DK

EGYPTE

Mr M. HILAL
Président,
Egyptian Organization for Standardization
and Quality Control
2 Latin America Street, Garden City
CAIRO.
TP 20-2-26 355
TX 93 296 EOS
TG TAWHID

ESPAGNE

Membre à désigner par son Gouvernement
Correspondance adressée à :
Centro Espanol de Metrologia
c/ del alfar s/n
28760 TRES CANTOS (Madrid)
TP 34-1-803 33 03 TC 34-1-803 11 78
TX 47254 CEME E

ETATS-UNIS D'AMERIQUE

Mr S.E. CHAPPELL
Chief, Office of Standards Management
Office of the Associate Director for Industry
and Standards
National Institute of Standards and Technology
Bldg. 101, A625
GAITHERSBURG, Maryland 20899
TP 1-301-975 40 24 TC 1-301-963 28 71
TX 197674 NBS UT

ETHIOPIE

Mr Yohannes AFEWORK
Head of Technical Service
Ethiopian Authority for Standardization
P.O. Box 2310
ADDIS ABABA.
TP — 15 04 00 et 15 04 25
TG ETHIOSTAN

FINLANDE

Madame U. LÄHTEENMÄKI
Director of Metrology Department
Technical Inspection Centre
Box 204
SF 00181 HELSINKI 18
TP 358-0-61 671 TC 358-0-605 474
TG TEKTARTOS HKI

FRANCE

Mr Ph. BERTRAN
Sous-Directeur de la Métrologie
S.A.R.S.C.I. Ministère de l'industrie et de l'amé-
nagement du territoire
30-32, rue Guersant
75833 PARIS Cedex 17
TP 33-1-45 72 85 85 TC 33-1-45 72 87 57
TX 649 917 F

GRECE

Mr A. DESIS
Technical Officer
Directorate of Weights and Measures
Ministry of Commerce
Canning Sq.
10181 ATHENS
TP 30-1-36 14 168
TX 21 67 35 DRAG GR et 21 52 82 YPEM GR

HONGRIE

Mr D. BELEDI
Président, Országos Mérésügyi Hivatal,
P.O. Box 19
H-1531 BUDAPEST
TP 36-1-1567 722
TX 22-4856 OMH
TG HUNGMETER Budapest

INDE

Mr S. HAQUE
Director, Weights & Measures
Ministry of Food and Civil Supplies
Weights and Measures Unit
12-A, Jam Nagar House
NEW DELHI 110 011
TP 91-11-38 53 44
TX 31 61962 COOP IN
TG POORTISAHAKAR

INDONESIE

Mr G.M. PUTERA
Director of Metrology
Directorate General of Domestic Trade
Departemen Perdagangan
Jalan Pasteur 27
40171 BANDUNG.
TP 62-22-50 597 et 50 695
TX 28 176

IRLANDE

Mr J. LOWE
Assistant Secretary
Department of Industry and Commerce
Frederick Building, Setanta Centre,
South Frederick Street,
DUBLIN 2.
TP 353-1-61 44 44
TX 93478
TG TRADCOM Dublin

ISRAEL

Mr A. RONEN
Controller of Weights, Measures and Standards
Ministry of Industry and Trade
P.O.B. 299
JERUSALEM 91002
TP 972-2-27 241
TG MEMISCOM Jerusalem

ITALIE

Mr C. AMODEO
Capo dell'Ufficio Centrale Metrico,
Via Antonio Bosio, 15
00161 ROMA.
TP 39-6-348 78 34

JAPON

Mr S. HATTORI
Director General
National Research Laboratory of Metrology
1-4, Umezono 1-Chome, Tsukuba
IBARAKI 305.
TP 81-298-54 41 49 TC 81-298-54 41 35
TX 03652570 AIST
TG KEIRYOKEN TSUCHIURA

KENYA

Mr P.A. AYATA
Director of Weights and Measures
Weights and Measures Department
Ministry of Commerce
P.O. Box 41071
NAIROBI
TP 254-2-33 51 55 et 33 51 11
TG ASSIZERS, Nairobi

LIBAN

Membre à désigner par son Gouvernement
Correspondance à adresser à
Service des Poids et Mesures,
Ministère de l'Economie et du Commerce,
Rue Al-Sourati, imm. Assaf
RAS-BEYROUTH.
TP — 34 40 60

MAROC

Mr M. BENKIRANE
Chef de la Division de la Métrologie Légale
Direction de l'Industrie
5, rue Errich, Immeuble A, Quartier Hassan
RABAT.
TP 212-7-51 792
TX 31816 M

MONACO

Mr A. VEGLIA
Ingénieur au Centre Scientifique de Monaco
16, Boulevard de Suisse
MC 98000 MONTE CARLO
TP 33-93-30 33 71

NORVEGE

Mr K. BIRKELAND
Directeur Général
Service National de Métrologie
Postbox 6832 St. Olavs Plass
0130 OSLO 1
TP 47-2-20 02 26 TC 47-2-20 77 72

PAKISTAN

Mr M. ASAD HASAN
Director
Pakistan Standards Institution
39-Garden Road, Saddar
KARACHI-3.
TP 92-21-72 95 27
TG PEYASAI

PAYS-BAS

Mr J.A.J. BASTEN
Directeur, IJkwezen bv
Nederlands Meetinstituut nv
Postbus 654
2600 AR DELFT.
TP 31-78 33 23 00 TC 31-15-61 29 71
TX 38 373 IJKWZ NL

POLOGNE

Mr J. MACIEJEWICZ
Président
Polski Komitet Normalizacji, Miar i Jakosci
ul. Elekoralna 2
00-139 WARSZAWA.
TP 48-22-20 54 34
TX 813 642 PKN
TG PEKANIM

PORTUGAL

Mr A. CRUZ
Directeur du Service de la Métrologie
Instituto Português da Qualidade
Rua Prof. Reinaldo Santos
Lote 1378
1500 LISBOA
TP 351-1-78 61 58 TC 351-1-78 19 80
TX 65744 METROQ P

ROUMANIE

Mr I. ISCRULESCU
Directeur, Institutul National de Metrologie,
Sos Vitan-Birzesti nr. 11
BUCAREST 4.
TP 40-0-83 23 20
TX 11 871

ROYAUME-UNI

Mr P.B. CLAPHAM
 Director,
 National Weights and Measures Laboratory
 Stanton Avenue
 TEDDINGTON, Middlesex TW 11 OJZ
 TP 44-1-943 72 72 TC 44-1-943 72 70
 TX 9312131043 (WM G)

SRI LANKA

Mr H.L.R.W. MADANAYAKE
 Deputy Commissioner of Internal Trade
 Measurement Standards and Services Division
 Department of Internal Trade
 101, Park Road
 COLOMBO 5.
 TP 94-1-83 261

SUEDE

Mr R. OHLON
 Ingénieur en Chef, Statens Provningsanstalt.
 P.O. BOX 857
 S-501 15 BORÅS.
 TP 46-33-16 50 00 TC 46-33-13 55 02
 TX 36252 TESTING S

SUISSE

Mr P. KOCH
 Vice-Directeur, Office Fédéral de Métrologie,
 Lindenweg 50
 3084 WABERN/BE.
 TP 41-31-59 61 11 TC 41-31-59 62 10
 TX 912860 TOPO CH
 TG OFMET

TANZANIE

Mr A.H.M. TUKAI
 Commissioner for Weights and Measures
 Weights and Measures Bureau
 Ministry of Industries and Trade
 P.O. Box 313
 DAR ES SALAAM
 TP 64046/64797/64808
 TX 41 689 INDIS

TCHÉCOSLOVAQUIE

Mr M. CIBAK
 Director
 Czechoslovak Institute of Metrology
 L. Novomeskeho 4
 842 55 BRATISLAVA
 TP 42-7-329 820 et 329 865
 TX 92786 METR
 TG METR BRATISLAVA

TUNISIE

Mr Ali BEN GAID
 Président Directeur Général
 Institut National de la Normalisation
 et de la Propriété Industrielle
 Boîte Postale 23
 1012 TUNIS BELVEDERE
 TP 216-1-785 922 TC 216-1-781 563
 TX 13 602 INORPI

U.R.S.S.

Mr V.I. PUSTOVOIT
 Vice-Président
 Gosstandart
 Leninsky Prospect 9
 117049 MOSCOU.
 TP — 236 40 44
 TX 411 378 GOST
 TG Moskva-Standart

YOUgoslavIE

Mr M. MEZEK
 Directeur
 Bureau Fédéral des Mesures et Métaux Précieux
 Mike Alasa 14
 11000 BEOGRAD.
 TP 38-11-18 37 36
 TX 11 020 YUZMBG

TP = telephone TC = telecopie (telex)

Les numéros sont en général indiqués pour le régime automatique international à l'exception des numéros qui sont précédés d'un trait.

The call numbers are generally indicated for international automatic dialling except where the local number is preceded by a dash.

TG = telegramme TX = telex

Pour tout télex ou télégramme, il est nécessaire d'indiquer le nom de la personne et sa qualité.

For all telex or telegrams it is necessary to indicate name of person and occupation.

PRESIDENCE

Président K. BIRKELAND, Norvège
Vice-Président S.E. CHAPPELL, U.S.A.
Vice-Président N...

CONSEIL DE LA PRESIDENCE

K. BIRKELAND, Norvège, Président
S.E. CHAPPELL, U.S.A., V/Président
M. KOCHSIEK, Rép. Féd. d'Allemagne Ph. BERTRAN, France
P.B. CLAPHAM, Royaume-Uni
Le Directeur du Bureau International de Métrologie Légale

BUREAU INTERNATIONAL DE METROLOGIE LEGALE

Directeur B. ATHANÉ
Adjoint au Directeur S.A. THULIN
Adjoint au Directeur F. PETIK
Ingénieur Consultant W.H. EMERSON
Administrateur Ph. LECLERCQ

MEMBRES D'HONNEUR

J. STULLA-GOTZ, Autriche — Président du Comité
H. MOSER, Rép. Féd. d'Allemagne — Membre du Conseil de la Présidence
V. ERMAKOV, U.R.S.S. — Vice-Président du Comité
A.J. van MALE, Pays-Bas — Président du Comité
A. PERLSTAIN, Suisse — Membre du Conseil de la Présidence
W. MUEHE, Rép. Féd d'Allemagne — Vice-Président du Comité
H.W. LIERS, Rép. Dém. Allemande — Membre du Conseil de la Présidence

ADRESSES DES SERVICES DES MEMBRES CORRESPONDANTS

ALBANIE

Directeur
Drejtoria e Standardeve dhe e Mjeteve
Matëse (DSMA)
në Komisionin e Planit të Shtetit
TIRANA

BAHREIN

The Responsible of Metrology
Standards and Metrology Section
Ministry of Commerce and Agriculture
P.O. Box 5479
MANAMA

BANGLADESH

Director General
Bangladesh Standards and Testing Institution
116-A, Tejgaon Industrial Area
DHAKA 1208

BARBADE

Director
Barbados National Standards Institution
Culloden Road
St. Michael
BARBADOS W.I.

BOTSWANA

The Permanent Secretary
Division of Weights and Measures
Department of Commerce and Consumer Affairs
Private Bag 48
GABORONE

BURKINA FASO

Direction Générale des Prix
Ministère du Commerce
et de l'Approvisionnement du Peuple
B.P. 19
OUAGADOUGOU

COLOMBIE

Superintendencia de Industria y Comercio
Centro de Control de Calidad y Metrología
Cra. 37 No 52-95, 4° piso
BOGOTA D.E.

COSTA RICA

Oficina Nacional de Normas y Unidades
de Medida
Ministerio de Economía y Comercio
Apartado 10 216
SAN JOSE

EQUATEUR

The Director General
Instituto Ecuatoriano de Normalización
Calle Baquerizo Moreno No 454
entre 6 de Diciembre y Almagro
Casilla No 3999
QUITO

FIDJI

The Chief Inspector of Weights and Measures
Ministry of Economic Development, Planning
and Tourism
Government Buildings
P.O. Box 2118
SUVA

GHANA

Ghana Standards Board
Kwame Nkrumah Conference Centre
(Tower Block - 2nd Bay, 3rd Floor)
P.O. Box M-245
ACCRA

HONG-KONG

Commissioner of Customs and Excise
(Attn. Trading Standards Investigation Bureau)
Tokwawan Market & Government Offices
165, Ma Tau Wei Road
11/F., Kowloon
HONG KONG

IRAK

Planning Board
Central Organization for Standardization
and Quality Control
P.O.B. 13032
Al Jadiria
BAGHDAD

ISLANDE

The Director
Weights and Measures in Iceland
Löggildingarstofan
Sidumula 13
P.O. Box 8114
128 REYKJAVIK

JORDANIE

Directorate of Standards
Ministry of Industry and Trade
P.O. Box 2019
AMMAN

KOWEIT

The Under Secretary
Ministry of Commerce and Industry
Department of Standards and Metrology
Post Box No 2944
KUWAIT

LIBYE

The Director General
National Centre for Standardization
and Metrology
(N.C.S.M.)
P.O. Box 5178
TRIPOLI

LUXEMBOURG

Le Préposé du Service de Métrologie
Administration des Contributions
Rue des Scillas
2529 HOWALD

MALAISIE

The Acting Director of Standards
Standards and Industrial Research Institute of
Malaysia
P.O. Box 35, Shah Alam
SELANGOR

MALI

Le Directeur Général des Affaires Economiques
(Service des Poids et Mesures)
B.P. 201
BAMAKO

MAURICE

The Permanent Secretary
Ministry of Trade and Shipping
(Division of Weights and Measures)
New Government Centre
PORT LOUIS

MEXIQUE

Direccion General de Normas
Secretaria de Comercio y Fomento Industrial
Sistema Nacional de Calibracion
Ave. Puente de Tecamachalco no. 6 - Planta Baja
Lomas de Tecamachalco, Seccion Fuentes
53950 NAUCALPAN DE JUAREZ

NEPAL

The Chief Inspector
Nepal Bureau of Standards and Metrology
P.B. 985
Sundhara
KATHMANDU

NOUVELLE-ZELANDE

The Chief Inspector of Weights and Measures
Ministry of Commerce
P.O. Box 1473
WELLINGTON

OMAN

The Director General
for Specifications and Measurements
Ministry of Commerce and Industry
P.O. Box 550
MUSCAT

PANAMA

Le Directeur
Comision Panamena de Normas Industriales
y Tecnicas
Ministerio de Comercio e Industrias
Apartado 9658
PANAMA 4

PEROU

The Director General
ITINTEC Instituto de Investigacion Tecnologica
Industrial y de Normas Tecnicas
Apartado 145
LIMA 100

PHILIPPINES

The Director
Product Standards Agency
Ministry of Trade and Industry
Trade & Industry Building
361 Sen. Gil J. Puyat Avenue
Makati, Metro Manila
PHILIPPINES 3117

SENEGAL

Monsieur le Directeur
Institut Sénégalais de Normalisation
Ministère du Plan et de la Coopération
DAKAR

SEYCHELLES

The Director
Seychelles Bureau of Standards
P.O. Box 199
INDEPENDENCE HOUSE

SYRIE

The General Director
The Syrian Arab Organization
for Standardization and Metrology
P.O. Box 11836
DAMASCUS

TRINITE ET TOBAGO

The Director
Trinidad and Tobago Bureau of Standards
P.O. Box 467
PORT OF SPAIN

TURQUIE

Monsieur le Directeur Général
Service du Contrôle de la Qualité et des Mesures
Sanayi ve Ticaret Bakanligi
Ölçüler ve Kalite Kontrol Genel
Müdürlüğü
ANKARA

VENEZUELA

Le Directeur
Direccion General de Tecnologia
Servicio Nacional de Metrologia
Ministerio de Fomento,
Av. Javier Ustariz, Edif. Parque Residencial
Urb. San Bernardino
CARACAS.

Grande Imprimerie de Troyes, 130, rue Général-de-Gaulle, 10000 TROYES
Dépôt légal n° 8264 - Avril 1990

