

Bulletin OIML n° 101
Décembre 1985

ISSN 0473-2812

BULLETIN

DE

L'ORGANISATION

INTERNATIONALE

DE MÉTROLOGIE LÉGALE

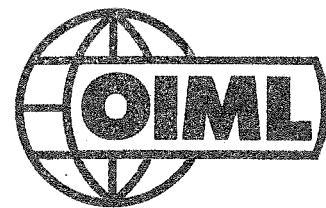

Meilleurs vœux

Organe de Liaison entre les Etats membres

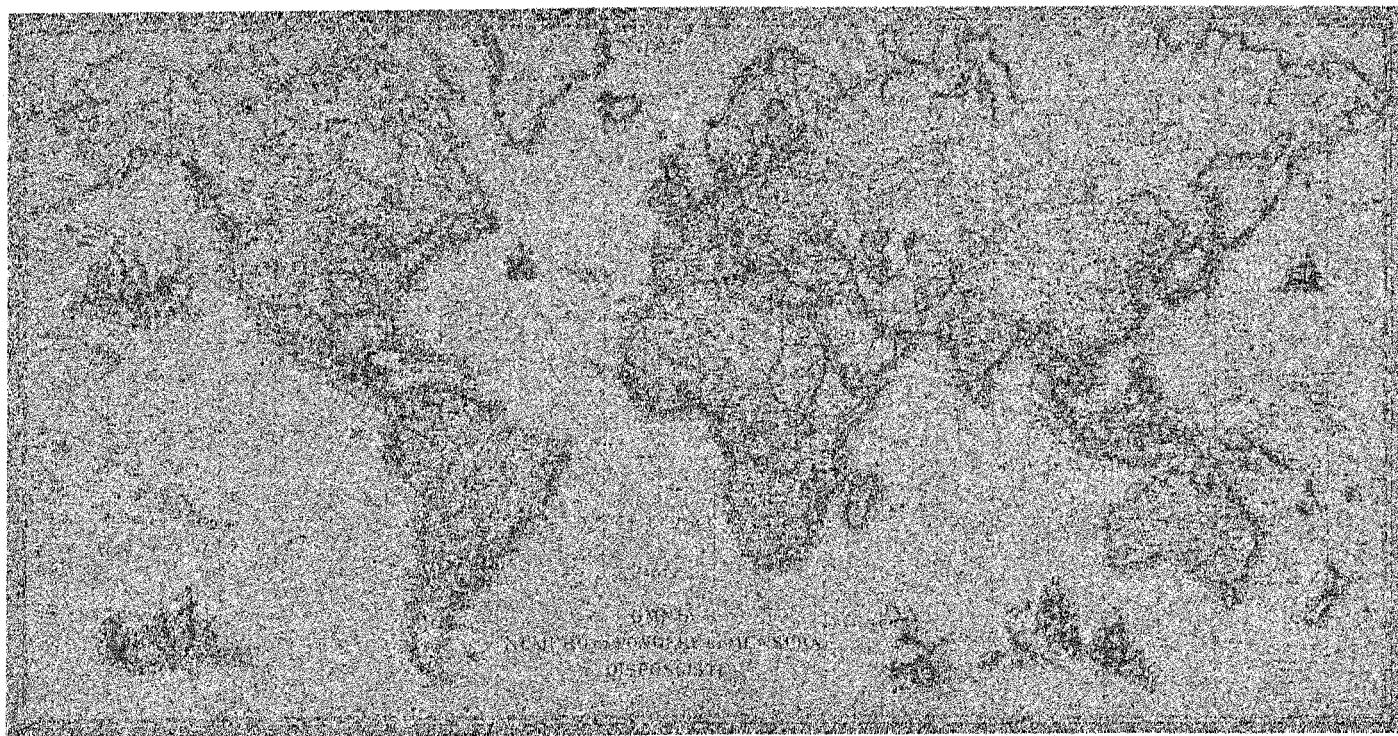

BUREAU INTERNATIONAL DE METROLOGIE LEGALE
11, Rue Turgot — 75009 PARIS — France

BULLETIN
de
L'ORGANISATION INTERNATIONALE de MÉTROLOGIE LÉGALE

SOMMAIRE

	Pages
REPUBLIQUE FEDERALE D'ALLEMAGNE — Totalisateurs discontinus, installation et vérification par P. WASSER	3
FEDERAL REPUBLIC OF GERMANY — Discontinuous totalizers, their installation and testing par P. WASSER	16
ROYAUME-UNI — Testing of automatic rail-weighbridges par R. ROBINSON	23
ISO — Weighing of copper concentrate par D.R.R. GOWDIE et J. van der LINDEN	35
Littérature	43
Literature	44
 INFORMATIONS	
Réunions	46
 DOCUMENTATION	
Publications : Liste complète à jour	47
Etats membres de l'Organisation Internationale de Métrologie Légale	52
Membres actuels du Comité International de Métrologie Légale	53
Adresses des Services des Membres Correspondants	58

Abonnement pour 1986 : Europe : 100 F-français
Autres pays : 120 F-français
Chèques postaux : Paris 8 046-24 X
Banque de France : B.P. 140-01 - 75049 Paris Cedex 01
Comptes Courants, Banques Etrangères, Cpte n° 5051-7

BUREAU INTERNATIONAL DE METROLOGIE LEGALE
11, Rue Turgot — 75009 Paris — France
Tél. 33 (1) 48 78 12 82 Le Directeur : Mr B. ATHANÉ
et 42 85 27 11
TELEX : SVPSV 660870 F ATTN OIML

Monsieur COSTAMAGNA N'EST PLUS

Nous venons d'apprendre avec la plus grande tristesse le décès, survenu le 24 décembre 1985, de Monsieur Marcel COSTAMAGNA, Directeur du Bureau International de Métrologie Légale de 1956 à 1973 et dont le rôle dans la création de notre Organisation fut prépondérant.

Nous reviendrons sur la carrière et l'œuvre de Monsieur COSTAMAGNA dans un prochain Bulletin.

Mr COSTAMAGNA IS NO MORE

We have just learned with great sorrow of the death on 24 December 1985 of Mr Marcel COSTAMAGNA who was Director of the International Bureau of Legal Metrology from 1956 to 1973 and who had a predominant role in the creation of our Organisation.

We shall give an account of his career and achievements in a forthcoming Bulletin.

TOTALISATEURS DISCONTINUS, INSTALLATION et VERIFICATION *

par P. WASSER **

RESUME — Les totalisateurs discontinus à trémie se prêtent particulièrement bien à la pesée de produits agro-alimentaires. Leur installation nécessite cependant certaines précautions : sécurités de remplissage, protections contre les turbulences d'air créées par les masses en mouvement, etc. L'étalonnage statique par des poids étalons, selon la RI N° 3 de l'OIML, doit être complété par des essais matières en marche automatique. L'expérience semble montrer qu'une erreur maximale tolérée de $\pm 1,25$ g par kg de charge peut alors être respectée dans la plupart des cas. L'auteur décrit la procédure de ces essais.

Il existe différentes méthodes pour contrôler les masses de produits en vrac. Une des plus fréquemment utilisée est le contrôle discontinu par totalisateur. La masse totale à déterminer est fractionnée en charges isolées dont les poids sont additionnés et enregistrés par le dispositif de commande du totalisateur.

Dans ces installations, les produits sont acheminés dans une trémie amont équipée d'un dispositif d'alimentation à commande pneumatique (Fig. 1). Le produit à peser s'écoule dans le totalisateur, il est mesuré, enregistré et déchargé dans une trémie aval pour être expédié.

Dans la plupart des installations modernes, le pesage se fait par dynamomètres à jauges de contrainte. Ces derniers sont reliés à un module de contrôle à microprocesseur qui en assure la commande automatique. Des sécurités et des verrouillages garantissent qu'aucune quantité de produit ne peut être expédiée sans que son enregistrement soit fait.

La visualisation sur écran permet à tout moment de faire connaître la situation du travail en cours ainsi qu'un volume important d'informations complémentaires.

La position des différentes informations visualisées répond à un souci d'esthétique, mais aussi au désir d'être en accord avec la normalisation des signes. Sur l'écran on peut voir apparaître (Fig. 2) :

- En haut à gauche : l'heure et la date.
- Légèrement dessous en encadré : la totalisation du poids.
- Au centre à gauche : le détail de la transaction en cours avec code d'identification, mode choisi (expédition ou réception), poids unitaire, etc. Cette même zone est utilisée pour dialoguer avec l'opérateur lors des opérations d'étalonnage et de remise à jour des constantes.
- La partie droite est réservée au synoptique du fonctionnement du totalisateur. L'affichage du nombre de décharges est également indiqué.
- A l'extrême droite de l'écran apparaissent les informations d'état du système (messages d'alarmes, d'état, d'informations).

(*) Cet article reproduit sous forme bilingue l'exposé présenté en français au Séminaire de l'OIML sur le Contrôle des Installations de Pesage en Vrac, Paris 22-25 avril 1985.

(**) Chronos-Richardson GmbH, Postfach 1240, 5202 Hennef 1.

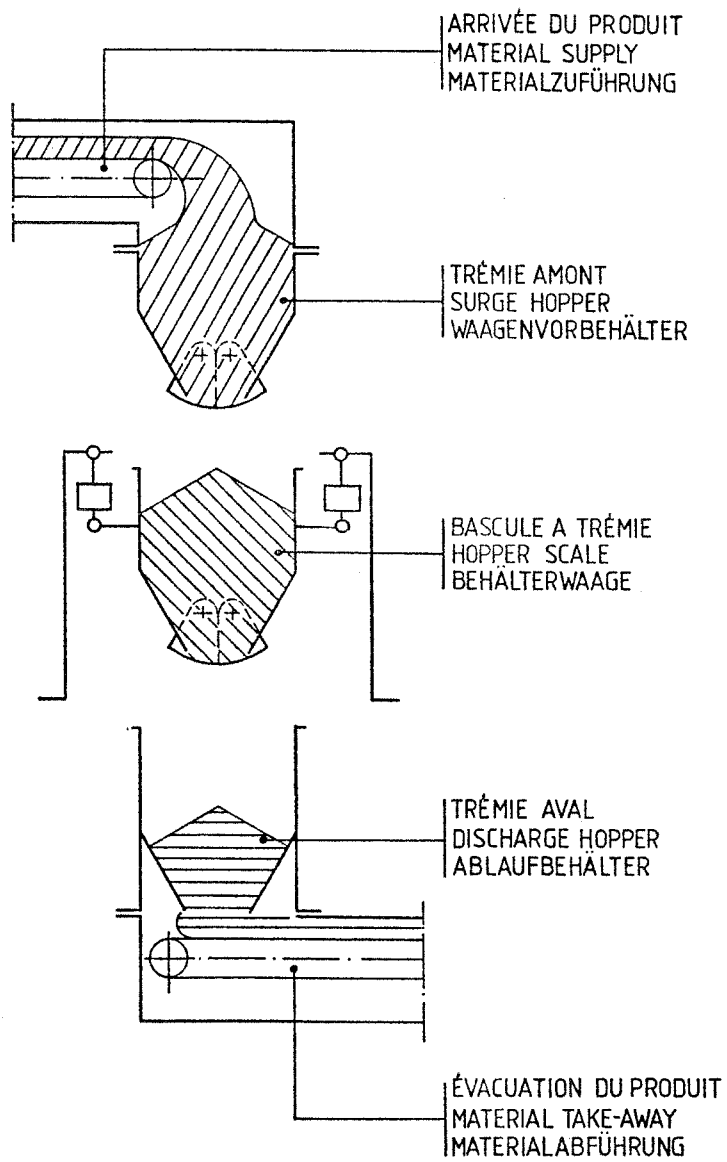

Fig. 1

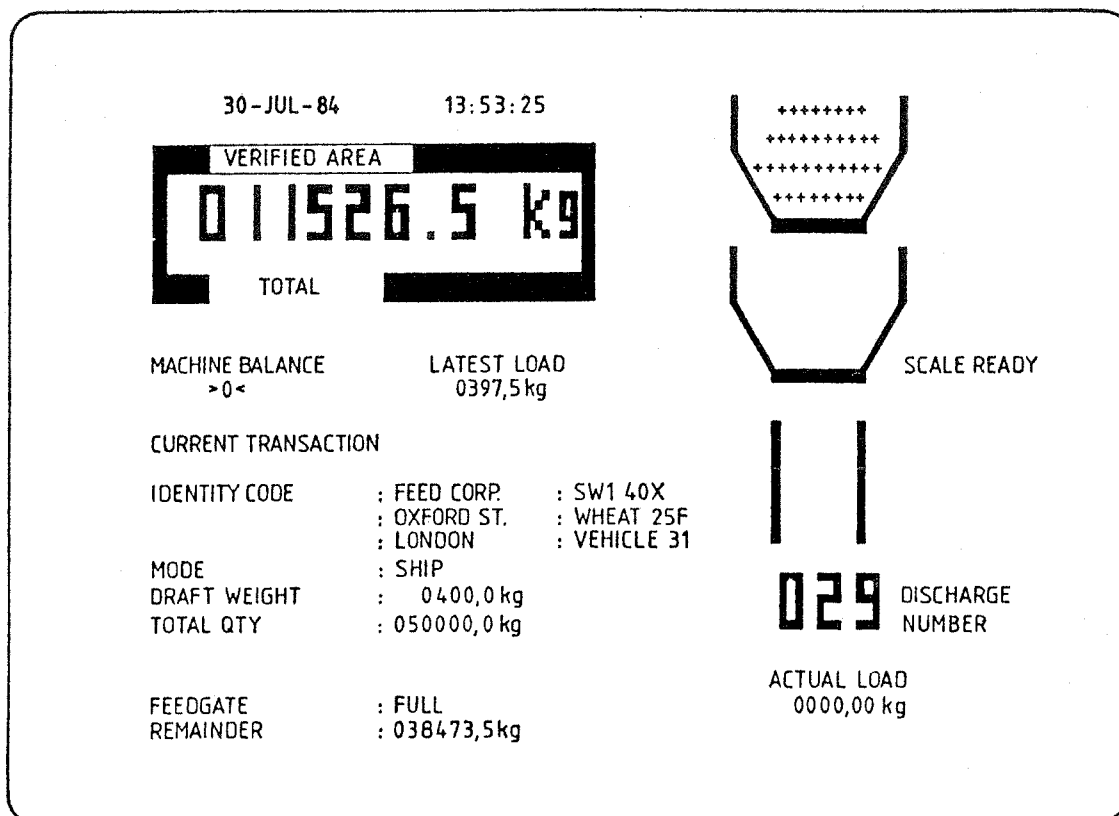

Fig. 2

Outre la commande de l'installation et la visualisation des informations sur l'écran, le module de contrôle permet le raccordement d'une imprimante. Les données pour chaque transaction sont enregistrées soit sur papier en continu, soit sur ticket. De plus, il existe un canal disponible pour l'échange des informations de gestion avec un ordinateur.

Les totalisateurs de réception ou d'expédition du type discontinu sont utilisés dans de nombreuses industries et en particulier, dans celles où les produits coûteux sont manipulés par petites ou moyennes charges.

Par exemple, dans les industries agro-alimentaires telles que :

- Silos à grain,
- Usines d'aliments du bétail,
- Meunerie,
- Entrepôts de stockage, etc.

D'autres produits en vrac tels que charbon, minerais, minéraux, gravier, sable, etc., sont de préférence pesés en continu par des intégratrices ou à l'aide de ponts-bascules.

L'aspect physique des produits étant différent, il est nécessaire d'appliquer suivant leur caractéristique d'écoulement souvent difficile, un principe de pesage et de mesurage approprié.

Le principe de pesage par différence est adapté à ce but. Le poids du produit restant dans la benne du totalisateur après la décharge est déduit du poids de la benne pleine. Cette différence est enregistrée et ajoutée au total.

Lorsqu'une imprimante est raccordée il est possible d'imprimer les totaux de chaque benne pleine, de chaque benne vide et les résultats cumulés de leur différence (Fig. 3).

EXEMPLE DE MODE RECEPTION

```

BULKTRONIC 4
02-JUN-84      12:46
TRANSACTION    : GROUPEMENT
                : MINIER
                : DE FRANCE
                : CALAIS
                : TYPE C/008
                : DD/987321

MODE           : RECEPTION
    
```

HEURE	CHARGE		POIDS		SOUS-TOTAL
12:46		V	0000.5	kg	
12:46		P	0250.1	kg	
12:46	001				000249.6 kg
12:47		V	0000.4	kg	
12:47		P	0233.8	kg	
12:47	002				000483.0 kg
12:47		V	0000.4	kg	
12:47		P	0261.1	kg	
12:48	003				000743.7 kg
12:48		V	0000.5	kg	
12:48		P	0250.6	kg	
12:48	004				000993.8 kg
12:48		V	0000.5	kg	
12:48		P	00218.9	kg	
12:49	005				001212.2 kg
12:49		V	0000.4	kg	
12:49		P	0240.9	kg	
12:49	006				001452.7 kg
12:50		V	0000.4	kg	
12:50		P	0253.1	kg	
12:50	007				001705.4 kg
12:50		V	0000.4	kg	
12:51		P	0221.9	kg	
12:51	008				001926.9 kg
12:51		V	0000.4	kg	
12:51		P	0236.1	kg	
12:51	009				002162.6 kg

```

02-JUN-84      12:51
FIN DE TRANSACTION
    
```

POIDS TOTAL 002162.6 kg

EXEMPLE DU TEST IMPRIMANTE GENERE PAR LE BULKTRONIC

```

02-JUN-84      12:13 MODE ESSAIS
TEST IMPRIMANTE
    
```

```

t"#1b&'()*+,-./0123456789:; = g
kABCDEFGHIJKLMNPOQRSTUVWXYZ ( )
    
```

Fig. 3

Les caractéristiques des produits à peser nous obligent à préconiser une forme et une disposition des trémies d'alimentation et d'évacuation. Les pentes des parois des trémies, et les dimensions des sections de passage sont calculées pour permettre un écoulement impeccable des produits les plus difficiles. Les vannes d'alimentation et de décharge sont prévues étanches pour éviter toute fuite de produit lorsqu'elles sont en position fermée. Elles sont munies de contacteurs fin de course pour signaler leur position de travail au contrôle.

Une sécurité supplémentaire est donnée par l'installation d'un pressostat sur les circuits de distribution d'air comprimé. Ce dernier surveille la pression et donne l'alarme si la pression tombe en-dessous d'une valeur minimale. Un réservoir de secours assure la fermeture des vannes d'alimentation ou de décharge éventuellement ouvertes jusqu'au retour à la pression normale du réseau d'alimentation pneumatique.

Lorsque le totalisateur doit travailler à des températures inférieures à 5°C, il est recommandé de prévoir un système anti-gel sur les circuits pneumatiques pour éliminer tout risque de givrage et assurer le bon fonctionnement de l'ensemble. La capacité de la trémie amont doit être suffisante pour stocker la quantité de produit qui s'accumule pendant les opérations de pesage de la benne pleine, de la benne vide et de la décharge. A titre de sécurité il est recommandé d'installer un indicateur de niveau assurant l'arrêt des dispositifs d'alimentation du produit en amont de la peseuse si le niveau maximum est dépassé. Cet indicateur de niveau peut être intégré dans les contrôles du totalisateur pour valoriser la compensation. On élimine ainsi le risque d'une surcharge de benne de pesage avec des produits d'une densité élevée ou d'un écoulement rapide.

De plus, il est possible de choisir entre une position partiellement ou complètement ouverte de la vanne d'alimentation ce qui permet de tenir compte des différents écoulements de chaque produit.

L'alimentation du totalisateur peut également se faire à deux vitesses. Ce type d'alimentation est utilisé lors des deux dernières pesées dans le cadre d'une expédition en vrac de produit. Quand on cherche à obtenir un chargement d'une quantité déterminée et avec la plus grande précision possible, le totalisateur définit automatiquement en deux parties égales ses dernières pesées.

La capacité de la trémie-peseuse est définie par la capacité du système de pesage et par la nature du produit à peser. Si le totalisateur est destiné à travailler sur des produits d'une densité variable, il est nécessaire de pré-afficher le poids unitaire correspondant à la capacité de la trémie-peseuse. Lors de l'étalonnage du module, les portées maximum et minimum du totalisateur sont rentrées dans les constantes. Le système est donc en mesure de refuser les poids unitaires qui ne correspondraient pas à la capacité minimum ou maximum de la trémie-peseuse. De plus, il est prévu une limite de surcharge dans les constantes qui surveille le remplissage de la trémie-peseuse.

En marche automatique, si des pesées sont en dehors des limites fixées, une alarme apparaît sur l'écran dans un rectangle surilluminé.

Si la limite de surcharge est dépassée, le cycle automatique s'arrête jusqu'à la disparition de l'alarme.

Dans certaines conditions d'installation et/ou d'utilisation, il est impossible ou très difficile d'éviter une surcharge. Dans ce cas, il est souhaitable de prévoir un indicateur de niveau dans la trémie-peseuse, ce dernier assurant une protection supplémentaire puisqu'il évite au produit de déborder de la trémie, de se déposer sur les vannes d'alimentation et cela dans l'hypothèse où l'arrêt de l'alimentation n'aurait pas été effectué.

La trémie aval doit recevoir au moins une pesée complète sans qu'il y ait risque d'enregistrer un poids erroné lors du contrôle de la trémie-peseuse à vide. Dans le cas d'un éventuel bourrage du circuit d'évacuation des produits, il est recommandé d'installer un indicateur de niveau dans la trémie aval permettant de verrouiller la décharge de la trémie-peseuse jusqu'à l'élimination du défaut (Fig. 4).

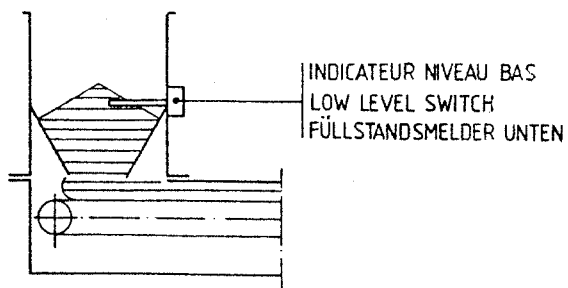
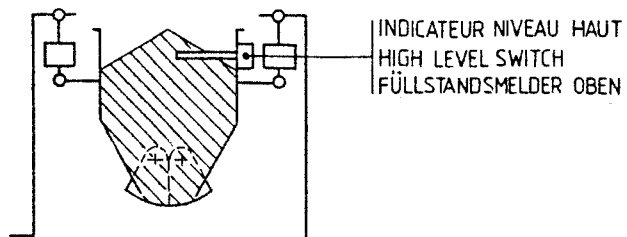
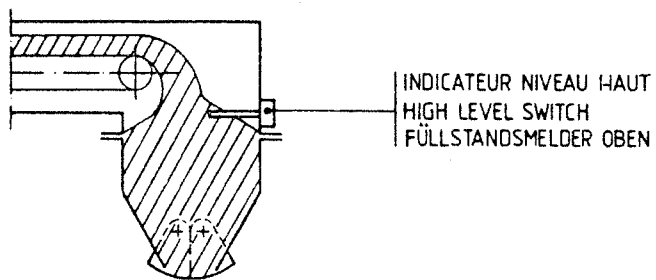

Fig. 4

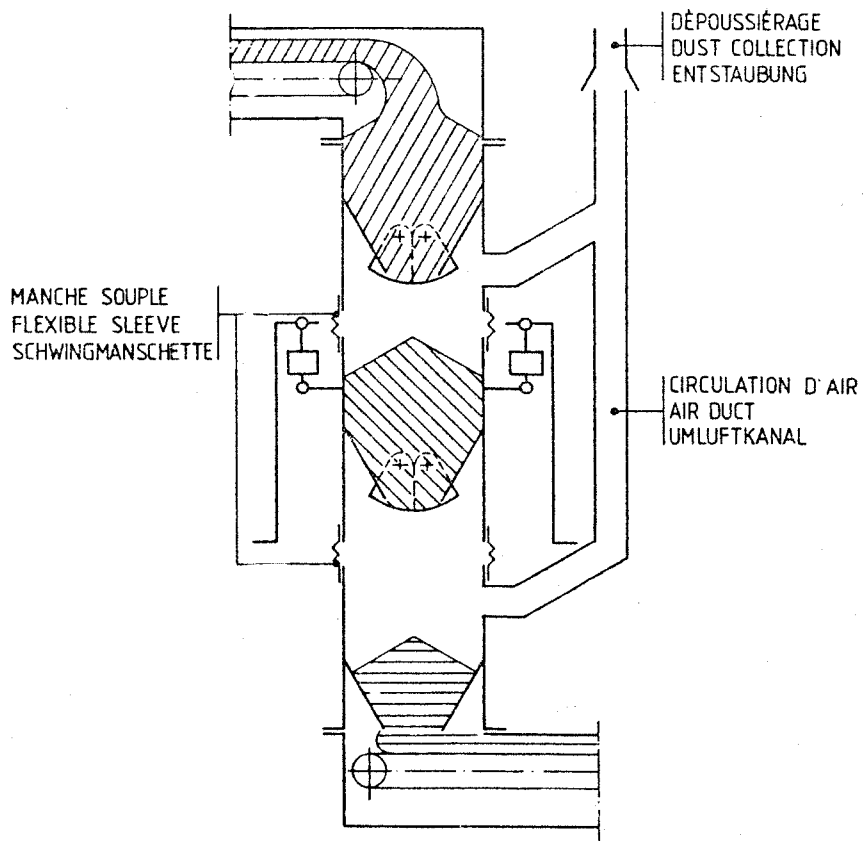

Fig. 5

Dans des circuits de manutention étanches, les masses de produit en mouvement peuvent causer des turbulences d'air qui peuvent perturber le pesage. Il y a donc lieu de prendre des précautions afin d'éliminer l'effet de ces turbulences dans la mesure du possible. Les manches souples qui sont normalement installées en haut et en bas de la trémie-peseuse ne sont pas suffisantes même si la matière est très poreuse à l'air. Il est important de veiller à ce que les manches aient une surface à peu près égale pour éviter les effets de surpression. Dans la plupart des cas, il s'avère nécessaire d'installer des conduits de circulation d'air permettant une compensation efficace de la pression en haut et en bas de la trémie-peseuse (Fig. 5).

Ces conduits de circulation peuvent être placés à l'extérieur ou à l'intérieur du poste de pesage. Leur section doit être suffisamment grande pour éviter la surpression.

A cet égard, il est également important de noter que le totalisateur est équipé d'un système de détection de mouvements. On considère que le totalisateur est stable si le contrôle d'un nombre successif de mesures se trouve à l'intérieur d'une zone de tolérance prédéterminée. On peut ainsi déterminer les variations de charge résultant des effets dynamiques de l'alimentation ou de la vidange de la trémie-peseuse. Lorsque les variations de charge causées par une circulation d'air sont lentes et de faible amplitude, il est nécessaire d'augmenter le délai de détection du mouvement. Le réglage de cette détection et sa temporisation se font de façon empirique lors de la mise en route.

Des vibrations du bâtiment peuvent également avoir un effet négatif sur la précision. Bien que des vibrations à haute fréquence peuvent être éliminées efficacement par des filtres à contrôle électronique et qu'il existe des châssis amortisseurs pour isoler le totalisateur des vibrations de la charpente support, il est indispensable d'éviter des vibrations inférieures à 12 Hz.

Des problèmes particuliers se posent lorsqu'il s'agit d'installer des totalisateurs sur navire ou sur élévateur flottant. Il existe des systèmes à cardans permettant de compenser les changements de niveau de ces derniers. Ces systèmes peuvent s'ajuster automatiquement en fonction de l'importance des mouvements. Les variations sont définies par rapport à la verticale et l'ajustage de la position du totalisateur se fait à l'aide de vérins hydrauliques.

Toutefois, il est à noter que la suspension à cardans n'est valable que pour des variations relativement faibles. Son efficacité se trouve nettement réduite lorsqu'il s'agit de roulis fréquents.

Par exemple, l'utilisation d'une suspension à cardans est utile s'il s'agit de compenser l'inclinaison d'un navire à la suite de son déchargement en eau tranquille. Elle est inutile s'il s'agit de roulis causés par une mer agitée. Il est clair qu'une suspension à cardans ne peut résoudre les problèmes posés par les mouvements verticaux.

Contrairement aux totalisateurs mécaniques fonctionnant selon le principe de l'équilibre des masses, les totalisateurs électroniques à jauge de contrainte sont sensibles aux poussées verticales qui faussent les résultats de pesage. Si le niveau d'eau varie fréquemment à cause des vagues, d'éclusage ou de trafic maritime, il peut arriver que ces perturbations interdisent l'utilisation des totalisateurs électroniques.

Les dimensions des totalisateurs et leur implantation dans les circuits de manutention rendent nécessaire un étalonnage sur place. Ceci est facilité par le fait que les modules de contrôle fonctionnent à base de microprocesseur et qu'ils sont programmés pour permettre une adaptation simple et rapide aux données de chaque installation. Le télécran permet un dialogue compréhensible et facilite l'adaptation rapide.

L'accès aux paramètres de fonctionnement et aux constantes du totalisateur se fait par codes à plusieurs niveaux suivant l'importance. Il existe des protections spé-

ciales dans le hardware de l'appareil pour des informations importantes. En dehors des informations non protégées, un certain nombre de paramètres protégés par code est normalement réservé au contremaître ou au chef d'atelier. Il s'agit par exemple, de la date et de l'heure, des temporisations pour l'alimentation et la décharge, des temporisations pour la stabilisation, les points de coupure, la sélection de l'imprimante, etc.

Les constantes du totalisateur spécialement protégées sont normalement : le symbole d'unité de mesure, la portée maximale, la portée minimale, l'échelon, la capacité de la trémie-peseuse, les limites pour le réglage du zéro, l'ajustage semi-automatique de la gamme et éventuellement la valeur de la masse étalon.

Afin de procéder à l'étalonnage du totalisateur, il est d'abord nécessaire d'effectuer un réglage à zéro. Dans ce but il faut que la trémie-peseuse soit complètement vide. Les manches, les portes de visite, les tuyaux pneumatiques et les câbles électriques doivent être mis en place correctement. Les poids de vérification doivent être enlevés.

Le réglage grossier du zéro se fait par enclenchement ou déclenchement des petits contacts du bloc commutateur binaire servant à calibrer la précharge sur la carte analogique. Le réglage fin se fait par potentiomètre. En marche normale, le symbole zéro est illuminé sur l'écran aussi longtemps que la tare à vide ne dépasse pas la limite de $\pm 1/4$ d'échelon. La tare à vide du totalisateur peut être corrigée soit par touche manuelle, soit par système de réglage automatique dans une étendue de 4 % de la portée maximale.

L'ajustage de l'étendue de mesure se fait de la même manière par bloc commutateur binaire et le potentiomètre sur la carte analogique. Dans ce but, le totalisateur est chargé de masses étalons qui peuvent être déposées sur les rambardes de la trémie-peseuse. Selon la législation en vigueur dans les pays, et selon la capacité du totalisateur on peut aussi utiliser des masses de substitution qui se posent ou s'enlèvent automatiquement. Généralement, on cherche à utiliser une masse étalon qui correspond à peu près à la portée maximale du totalisateur. On enclenche ou déclenche les contacts du bloc commutateur binaire pour se rapprocher au maximum de la valeur qui correspond à la charge du totalisateur. Le réglage final se fait par potentiomètre.

L'étalonnage de la carte analogique étant effectué, il est possible de le vérifier et de le corriger en utilisant un circuit d'autocalibration. Si le totalisateur se trouve dans les limites acceptées pour l'étalonnage, il suffit d'introduire par le clavier numérique la valeur de la masse étalon choisie et le système effectue un centrage automatique de la valeur.

Il existe un autre bloc commutateur binaire sur la carte analogique qui permet de fixer un point de référence (vérification à 95 %) dans le cas où une telle vérification est demandée.

Il est évidemment nécessaire d'utiliser des jauges de contrainte et un convertisseur de haute qualité et d'une bonne linéarité pour obtenir des résultats de pesage parfaitement reproductibles. La capacité des jauges doit être en conformité avec la portée maximale du totalisateur et leur tension d'excitation doit être choisie en conséquence.

Etant donné que les totalisateurs utilisent généralement 2 ou 4 jauges (sauf les systèmes hybrides levier/jauge) il est nécessaire d'employer soit des jauges sélectionnées, soit de les réunir par une boîte de jonction et de prévoir des résistances de calibration dans leur circuit d'excitation afin de compenser les différences qui peuvent exister dans leur sensibilité ou leur impédance.

Afin de pouvoir déterminer la linéarité, il est usuel de faire des essais statiques permettant de vérifier toute la gamme du totalisateur par charge croissante ou décroissante. La vérification se fait par dixième de la portée maximale donc par charge de 100 kg pour un totalisateur de 1 000 kg par exemple.

Pour que la précision soit garantie, les essais statiques se font avec des masses étalon vérifiées. Dans ce but, la trémie-peseuse est prévue avec rambardes permettant le dépôt de ces masses. Il est évident que ce contrôle représente un travail considérable surtout s'il s'agit d'un totalisateur d'une portée élevée. Il faut veiller lors de l'installation du totalisateur à ce qu'il soit facilement accessible et que des moyens de manutention soient prévus pour le transport des masses étalons.

Si les rambardes pour les masses de contrôle peuvent se démonter, il est important que le totalisateur puisse être remis à zéro avec ou sans les rambardes.

Il est également possible de prévoir la construction du totalisateur avec des poids de contrôle à dépose pneumatique ce qui facilite considérablement les contrôles du totalisateur. Cependant, dans la pratique, ces systèmes s'appliquent généralement à des totalisateurs de petite ou de moyenne capacité et couvrent soit l'étendue totale soit une fraction de l'étendue de pesage.

Si les masses de contrôle ne couvrent qu'une partie de l'étendue de mesure, il faut appliquer la méthode successive qui est par ailleurs couramment acceptée pour les capacités plus élevées. Les charges de substitution sont normalement constituées par le produit à peser.

Les tolérances pour les essais statiques des instruments de pesage totalisateurs discontinus à fonctionnement automatique sont généralement les mêmes que pour les totalisateurs non automatiques et ne doivent pas dépasser les valeurs prescrites par la Recommandation OIML :

- ± 0,5 d pour les charges jusqu'à 500 d inclus,
- ± 1,0 d pour les charges comprises entre 500 d exclus et 2 000 d inclus,
- ± 1,5 d pour les charges supérieures à 2 000 d.

Il y a lieu de tenir compte de l'erreur d'arrondissement selon l'échelon de l'indicateur digital.

La vérification est considérablement facilitée par l'indicateur auxiliaire en bas et à droite du télécran qui permet de visualiser le poids réel à chaque instant. Cet indicateur peut être choisi à une résolution qui est 10 fois plus grande que celle du totalisateur, c'est-à-dire, qu'il permet une lecture directe de la charge en unité d'un dixième échelon et donc d'établir d'une manière très simple la courbe de l'erreur analogique (erreur statique du totalisateur). Pour les modules privés de ce dispositif, le seuil de passage doit être déterminé en utilisant la vérification par dixième échelon pour tous les poids lors des essais statiques et en marche automatique avec produit (Fig. 6).

Les essais en marche automatique ont pour but de déterminer le comportement du totalisateur lorsqu'il est soumis aux effets du produit en mouvement et aux autres conditions usuelles d'utilisation. Les tolérances admissibles doivent donc tenir compte de ces influences. En pratique, on trouve que l'erreur maximale de ± 1,25 g par kilogramme tolérée en R.F.A. peut être respectée dans la plupart des cas. L'erreur maximale de ± 2,5 g par kilogramme également tolérée en R.F.A. ne s'applique pratiquement pas parce que l'on considère que l'effort technique ne se justifie pas pour cette précision réduite. Lors du calcul de l'erreur maximale tolérée, il faut tenir compte de l'erreur d'arrondissement selon l'échelon de l'indicateur digital ; il s'applique une seule fois à chaque lot de pesage.

Afin d'avoir une référence pour cette précision, il faut déterminer la quantité minimale qui forme un lot cohérent de pesage. Donc, la quantité de produit qui doit passer par le totalisateur en marche automatique au cours de l'essai doit être égale à la quantité minimale du lot. Elle est fixée en nombre minimal de pesées individuelles à effectuer dont le total doit correspondre à la quantité minimale du lot. Le nombre minimal peut être une ou plusieurs pesées. La limite inférieure est généralement exprimée sous forme d'un multiple de l'échelon du totalisateur.

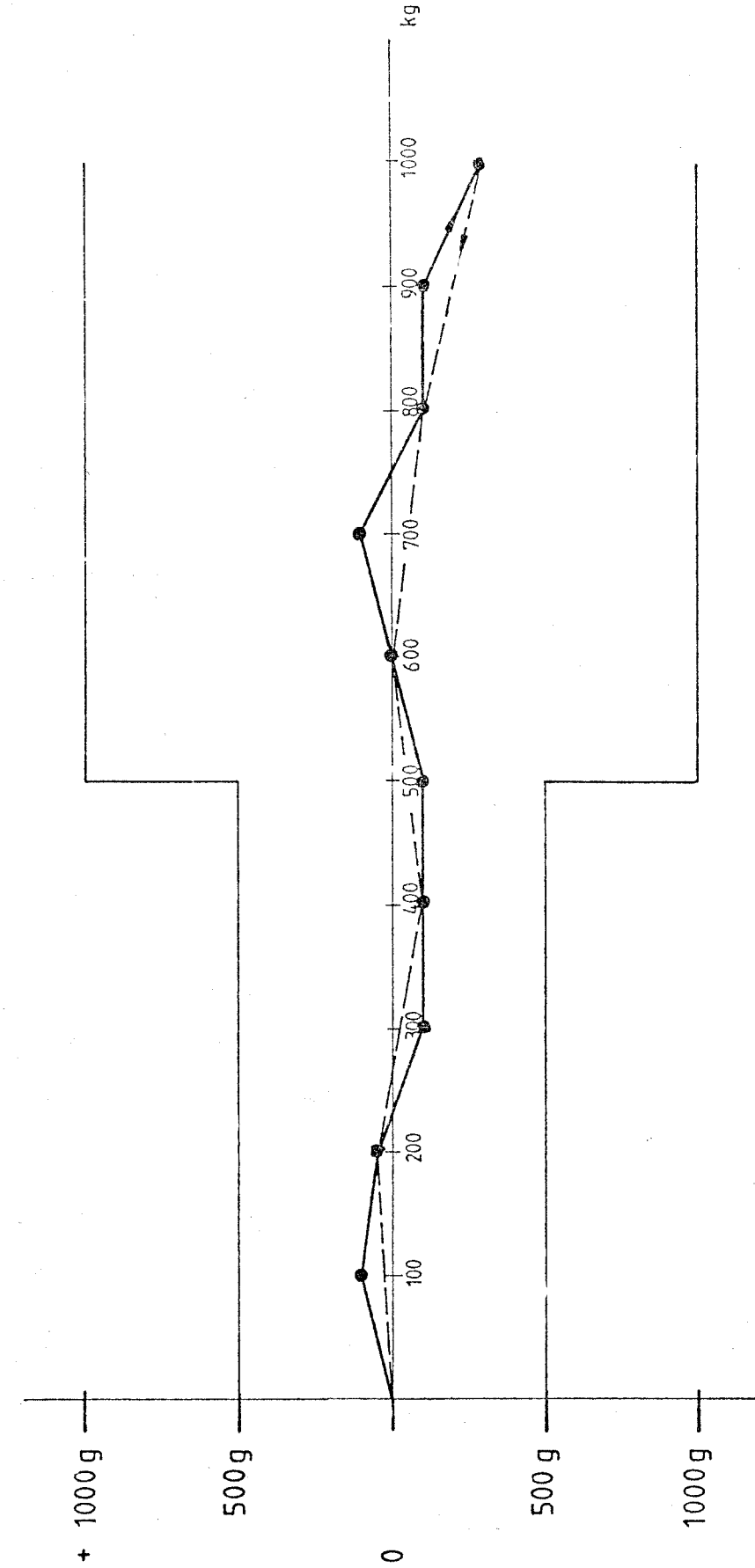

—●— Chargement croissant en pas de 100 kg (Load increasing in steps of 100 kg)

- -●- - Chargement décroissant en pas de 200 kg (Load decreasing in steps of 200 kg)

Fig. 6

VERIFICATION STATIQUE D'UNE BASCULE TOTALISATRICE AUTOMATIQUE EN MARCHÉ NON-AUTOMATIQUE
(STATIC VERIFICATION OF AN AUTOMATIC TOTALIZING BULK WEIGHER IN NON-AUTOMATIC OPERATION)

Caractéristiques : Max = 1 000 kg, Min = 300 kg, $d_a = 1$ kg

Quantité minimale par pesée (minimum transaction weight with one batch) : 1 000 kg

En effet, il est important de pouvoir effectuer la quantité minimale d'un lot en une pesée afin de répondre aux besoins de certaines industries (aliments du bétail, café par ex.) d'inscrire sur le bordereau le détail des différents composants d'un mélange qui passe sur le totalisateur. Evidemment, le totalisateur doit être contrôlé en conséquence et les limites d'erreurs doivent être respectées.

Les essais en marche automatique se font en plusieurs séries dont une avec un poids unitaire égal à la portée minimale, une autre avec un poids unitaire près de la portée maximale et une troisième avec un poids unitaire qui correspond à la charge intermédiaire du totalisateur. Chacune des séries doit comporter un nombre de pesées qui permet d'arriver à la quantité minimale du lot fixé en kilogrammes ou en tonnes.

Exemple :	Portée maximale	1 000 kg
	Portée minimale	300 kg
	Quantité minimale du lot	1 000 kg en une pesée

Les essais se font en trois séries :

4 pesées à	300 kg	=	1 200 kg
2 pesées à	500 kg	=	1 000 kg
1 pesée à	1 000 kg	=	1 000 kg

En marche automatique, les totalisateurs sont normalement contrôlés avec le produit pour lesquels ils sont destinés. Dans beaucoup de cas ils sont placés dans le bâtiment ou intégrés dans des circuits de manutention où il est très difficile de récupérer le produit pesé afin de le diriger sur un pesage de contrôle complémentaire.

Souvent, une bascule de contrôle complémentaire d'une capacité et d'une précision appropriée n'est pas disponible ou difficile à se procurer.

Par conséquent, il est usuel de contrôler les pesées effectuées automatiquement dans le totalisateur lui-même. Ceci suppose que le totalisateur est suffisamment précis et que l'erreur de linéarité constatée au cours des essais statiques soit connue et puisse être prise en compte lors de ce contrôle.

A nouveau, l'augmentation de la résolution de l'indicateur est très utile pour ce contrôle. Etant donné que cette méthode ne permet le contrôle que d'une pesée à la fois il est donc nécessaire de totaliser les pesées individuelles dans le protocole jusqu'à ce que la quantité minimale du lot soit atteinte.

Pour que les essais en marche automatique se déroulent dans les conditions usuelles d'utilisation, chaque pesée à contrôler est précédée d'un ou plusieurs cycles automatiques non contrôlés qui font circuler l'air dans les circuits étanches. Pour cette même raison, les élévateurs, compresseurs, systèmes de dépoussiérage et autres équipements produisant éventuellement des vibrations ou des perturbations doivent être mis en service afin de contrôler leur influence sur la précision du totalisateur.

On procède normalement comme suit :

- 1) Démarrer le cycle automatique.
- 2) Effectuer une ou plusieurs pesées afin d'établir des conditions usuelles d'utilisation.
- 3) Arrêter le cycle automatique par la touche « ARRET DE CONTROLE » qui permet de retenir le totalisateur avec la trémie remplie après enregistrement automatique du poids par le module indicateur ou par l'imprimante.
- 4) Déterminer le seuil de passage en ajoutant des poids de vérification ou enregistrer la lecture de l'indicateur auxiliaire après stabilisation complète de l'installation.

- 5) Débloquer la décharge automatique et retenir le totalisateur avec trémie vide après enregistrement automatique du poids par le module indicateur ou l'imprimante et ceci en appuyant à nouveau sur la touche « ARRET DE CONTROLE ».
- 6) Déterminer le seuil de passage en ajoutant des poids de vérification ou enregistrer la lecture de l'indicateur auxiliaire.
- 7) Répéter les opérations de 1 à 6 jusqu'à ce que le nombre des pesées contrôlées corresponde à la quantité minimale du lot.

L'analyse des résultats se fait comme suit :

- 8) Additionner tous les poids enregistrés en marche automatique (différence entre 3 et 5).
- 9) Additionner tous les poids déterminés en état stabilisé (différence entre 4 et 6).
- 10) La différence entre les totaux 8 et 9 ne doit pas dépasser les erreurs maximales tolérées pour la marche automatique déduction faite des écarts trouvés pour le poids unitaire correspondant lors des essais statiques après multiplication par le nombre des pesées effectuées pour ce lot.

Les résultats d'une vérification selon ce schéma sont illustrés par le Tableau 1.

Tableau 1

VERIFICATION SIMPLIFIEE D'UNE BASCULE TOTALISATRICE AUTOMATIQUE EN MARCHÉ AUTOMATIQUE
(SIMPLIFIED VERIFICATION OF AN AUTOMATIC TOTALIZING BULK WEIGHER
IN AUTOMATIC OPERATION)

Données de la bascule : Portée maximale (Maximum capacity) Max : 1 000 kg
(Weigher constants) Portée minimale (Minimum capacity) Min : 300 kg
Echelon (Scale interval) d_a : 1 kg
Quantité minimale d'un lot (Minimum transaction weight) : 1 000 kg par une pesée (with one batch)

Erreurs selon essai statique (Errors found in static test) : Charge (Load) 0 kg, Erreur (Error) \pm 0 kg
300 kg — 0,1 kg
500 kg — 0,1 kg
900 kg — 0,1 kg

Bascule pleine (full)		Bascule vide (empty)		Résultats nets		Erreur	Erreur maximale tolérée
Indication au repos (at rest) (kg)	Correction par erreur statique (kg)	Indication au repos (at rest) (kg)	Correction par erreur statique (kg)	Non-automatique (kg)	Automatique (kg)		
340,95	341,05	3,7	3,7		337		1,683
340,7	340,8	3,7	3,7		337		+ 0,500
339,7	339,8	3,7	3,7		336		
340,15	340,25	3,7	3,7		336		
	1 361,90		14,8		1 346		2,183
525,1	525,2	3,7	3,7		522		1,300
522,0	522,1	3,7	3,7		518		+ 0,500
	1 047,3		7,4		1 040		1,800
					1 039,9	+ 0,1	
927,45	927,55	3,7	3,7		923		1,154
	927,55		3,7		923		+ 0,500
					923,85		1,654
					923	- 0,855	

DISCONTINUOUS TOTALIZERS, THEIR INSTALLATION and TESTING *

by P. WASSER **

SUMMARY — Discontinuous totalizers (hopper scales) are well suited for the weighing of many agricultural products. Their installation requires however that special precautions are taken as regards for instance filling security devices, protections against air turbulences created by the moving material, etc. The static calibration which generally follows OIML R13 must be completed by material tests in automatic operation. Experience seems to show that a maximum permissible error of ± 1.25 g per kg of load can then be respected in most cases. The lecturer describes the full testing procedure.

The illustrations and the table referred to are those included in the preceding French version of this article.

There are different methods for the gravimetric measurement of bulk material. One of the methods that is frequently applied is by a discontinuous totalizing automatic weighing machine. The bulk product to be weighed is normally sub-divided into a number of individual batches, the weight of which is totalized and recorded.

In these installations (Fig. 1), the material is conveyed into a surge hopper which is provided with an air operated feeding device. The material flows into the weigh hopper, is weighed and recorded and then discharged into the take-away hopper.

In most modern installations, weight sensing is by strain gauge loadcells. They are connected to a microprocessor based control system with keyboard and weight display for automatic operation with all security interlocks provided to ensure reliable sequencing and protection against the passage of unrecorded material.

The video display provides for a large amount of information to be presented and keeps the operator fully updated on the actual situation of the process at any time.

The philosophy of the screen layout (Fig. 2), for the aesthetic appearance and in order to comply with regulatory approval bodies, is laid out as follows :

- Date and time displayed at the top of the screen.
- Totalized weight display in the enclosed screen area.
- Current transaction data, including ID code, mode, draft weight, etc., in the center of the screen.

This area is also used for operator interrogation when calibration and constants updating is required. The area to the right of the screen is dedicated to a mimic of the scale operation and the discharge number.

Weigher status conditions (alarm, operating, hold messages) appear to the right of the mimic.

* This paper is an English translation of the presentation in French by the author at the OIML Seminar on Testing of Bulk Weighing Installations, Paris 22-25 April 1985.

** Chronos-Richardson GmbH, Postfach 1240, 5202 Hennef 1.

Besides its control and sequencing functions, and the monitoring of process data on the screen, the controller can drive a printer which records the data for each transaction either on continuous paper or on tickets. In addition, there is a data communication channel which permits two-way communication with a remote computer.

Shipping and receiving systems of the discontinuous totalizing type are used in a great variety of industries and particularly in installations where costly materials are handled in small or medium size quantities. These are by tradition installations in the agricultural and food industries, for example :

- grain silos,
- feed mills,
- flour mills,
- warehouses, etc.

Other bulk products such as coal, ores, minerals, gravel, sand, etc. are preferably measured by belt weighers or weighbridges. Discontinuous totalizers sometimes have to weigh materials with poor flow characteristics. This is where the advantage of the discontinuous totalizing principle can be exploited for maximum accuracy. In the shipping mode the weight of material remaining in the weigh hopper after discharge is deducted from the weight of the filled weigh hopper, only the difference is added to the total. However, if a printer is connected, it is possible to print out the results of each full and empty weight as well as the accumulated subtotal (Fig. 3).

The hopper and feed and discharge gates are designed and arranged so that they are matched to the materials to be weighed. The hopper walls are sloped and the inlet and outlet sections are dimensioned to ensure proper operation even with the most difficult materials. The feed and discharge gates are sufficiently tight to prevent any leakage when closed. They are provided with limit switches that signal their position to the controller.

Additional safeguards are provided by the installation of pressure switches in the air lines that give an alarm message if the air pressure drops below minimum pressure. Feed or discharge gates that may be open can be closed by means of an emergency reservoir until normal air pressure is reestablished.

If the weigher has to operate at temperatures below 5°C it is recommended to install an anti-freeze device that prevents the pneumatic system from getting blocked by icing and maintains operating reliability.

The capacity of the surge hopper is sufficient to accommodate the quantity of material that accumulates during the full and empty weighing cycles as well as during scale discharge. For security reasons, it is recommended to install a level switch that stops the upstream material supply as soon as a high level situation occurs. This switch can also be wired with the weigher controls in order to initiate a higher than normal compensation setting as long as a high level condition exists. This prevents the weigh hopper from being overfilled when heavy fast-flowing materials are handled. In addition, it is possible to select the feed gate to a full or only partially open position in order to cope with the particular flow characteristics of the various materials.

In order to complete a shipping transaction without being left with a small final weightment, the controller adjusts the set weight, such that the transaction is divided into discharges of equal weight. As an additional precaution the target weight of the last two drafts are automatically split into two equal portions. This principle is normally used in the shipping mode when it is required to deliver a weight that is as close as possible to a preset total.

The size of the weigh hopper matches the capacity of the weighing system and the nature of the materials to be weighed. When the totalizing automatic weighing machine is used for materials that vary considerably in density, it is necessary to select the draft weights in accordance with the hopper capacity. For this purpose the weigh hopper capacity is entered together with maximum and minimum capacity

as one of the scale constants at commissioning. In this case, the controls will not validate the insertion of a draft weight that would exceed the weigh hopper capacity. Draft weight settings higher than maximum or lower than minimum weigher capacity will also be rejected. An overload tolerance is also entered with the weigher constants to monitor the filling cycle of the scale.

If, in automatic operation, weighments are recorded that are outside of the limits set, the controls generate an alarm message. In case the weight exceeds the overload tolerance, the automatic cycle is halted until the alarm condition is removed.

There may be installations or operating conditions that make it impossible or at least very difficult to correct an overload situation. Under such circumstances it can be helpful to install a level switch in the weigh hopper which provides an additional safeguard against overflow and prevents the material from overflowing the weigh hopper or from contacting the feed gates if the automatic cutoff was absent.

The discharge hopper holds at least one full draft in order to enable the weigher to discharge completely and to read the empty weight without being disturbed by any material built-up in the take-away system. For security reasons, it is recommended to install a level switch in the discharge hopper that prevents the weigher from discharging as long as the material from the preceding discharge has not cleared this switch (Fig. 4).

When installed in enclosed systems, the moving mass of material causes air turbulences that can affect the weighing results. It is, therefore, necessary to eliminate the effect of such turbulences as much as possible. The flexible sleeves that are normally fitted above and below the weigh hopper are not sufficient to cope with the problem even if they are made from porous material with a certain venting property. Though it is important that these sleeves have about the same surface area in order to have an equal effect, it is in most cases, mandatory to install an air by-pass for efficient pressure compensation above and below the weigh hopper (Fig. 5).

The air ducts can be placed inside or outside of the system. Their section should be wide enough to permit rapid air exchange.

In this connection, it is important to know that the weigher is equipped with a motion detector. A no-motion situation exists if the results of a selectable number of consecutive weight readings are all within a selectable tolerance band. Variations in the weigher load resulting from the impact of the material during feed and discharge can be properly sensed by this method. In order to cope with the relatively small and slow variations as they may be due to air circulation, the motion detector may have to be initialized with a certain delay. Both, the setting of the motion detector and the timer for its initialization have to be made on the basis of test results with material when the system is started up.

Vibration in the building can also have an effect on the weighing accuracy. Though high frequency vibration can be efficiently eliminated by the filters installed in the electronic controls and similarly shock absorbers may be fitted in the supporting structure to isolate the weigher from the building, it is mandatory to eliminate vibration below 12 Hz.

Particular problems may be expected when hopper scales are to be installed on ships or floating elevators. Cardan suspensions are available to compensate for the heeling. These systems adjust themselves automatically depending upon the amount of the movement. Any deviations from vertical are sensed and corrected by hydraulic positioning devices. However, it should be noted that cardan suspensions can only compensate for long term heeling and have only a limited efficiency when the rolling frequency is high. For instance, cardan suspensions are helpful to compensate the heeling of a ship due to its unloading in an otherwise quiet sea. They are of no use when the rolling is caused by a rough sea.

It should be clear that cardan suspensions cannot solve the problems that arise from vertical movements. Unlike mechanical weighers that are based on the principle of mass balancing, load cell weighers are sensitive to a buoyancy force which falsifies the weighing results. If the water level varies frequently because of waves, lock gate operation, or sea traffic, there can be situations in which it is not possible to use an electronic weigher.

Because of their dimensions and integration into the material handling process, the totalising automatic weighing machines have to be calibrated on site. Calibration is easy since the microprocessor-based controller is programmed to easily suit the characteristics of each installation. The full screen presentation permits a comprehensive dialog that helps to adapt the system with minimum effort.

Access to the function parameters and weigher constants is subdivided into various access levels depending upon the importance and secured by code. Areas that are of prime importance are, in addition, secured by particular protections in the hardware.

Besides the normal operating parameters that are accessible with no restriction, there is a certain number of parameters secured by entry code which are normally reserved for the foreman or the plant manager. This includes, for instance, date and time, timer settings for material feed and discharge, settings for stabilization times, cut-off, printer selection, etc.

The weigher constants that are normally under particular protection are : the weight units, the maximum capacity, the minimum capacity, the scale interval, the capacity of the weigh hopper, the zero offset limit, the span factor limit, and eventually the calibration weight value.

The calibration of the totalising automatic weighing machine starts with zero adjustment. For this purpose, the weigh hopper must be completely empty. The flexible sleeves, access doors, air hoses, and power lines must be correctly fitted. Test weights must be removed.

Coarse zero adjustment is made by the pertaining bank of binary resistance switches for pre-load setting on the analogue-board. Final adjustment is made by potentiometer. In normal operation, the zero symbol will be shown on the screen as long as the empty tare is within the limits of 1/4 of the scale interval. The empty tare can be corrected in a range of 4 % of maximum capacity either by key or by an automatic zero tracking system.

Span adjustment is accomplished in the same way by its associated bank of binary resistance switches and potentiometer of the analogue board. For this purpose the weigh hopper has to be loaded with standard loads which can be placed on the frame fixed to the weigh hopper. Depending upon the national regulations and the capacity of the weigher, it may also be possible to use test weights that can be placed and removed automatically. In general, span calibration should be performed with a calibration mass that equals the maximum weigher capacity. The resistance switches are operated to obtain a weight reading that is as close as possible to the value of the weights that are placed on the weigh hopper. Final adjustment is by potentiometer.

When the calibration of the analogue board is complete, it is possible to check and correct the span adjustment by an auto-calibration software. If the weigher is within its normal calibration limits, it suffices to key in the value of the calibration mass applied and the system will automatically trim itself on that value.

Another bank of dip switches is available on the analogue board that permits setting of a reference point (95 % check) in cases where such a verification is required.

Obviously, it is necessary to use loadcells and a signal conditioner of high quality and good linearity in order to obtain reproducible weighing results. The capacity of the loadcells must be in accordance with the maximum capacity of the weigher, and

their excitation voltage has to be chosen accordingly. Generally, 2 or 4 loadcells are used (except combined lever/loadcell systems) and it is, therefore, necessary to either use selected cells or to connect them via a junction box and to provide small amounts of resistance in the excitation leads of the cells in order to compensate for differences that may exist in their sensitivity or impedance.

The linearity is usually determined by a static test over the full weighing range with increasing and decreasing loads. The test is made in steps of one tenth of maximum capacity, i.e., with load steps of 100 kg for a weigher having a maximum capacity of 1 000 kg.

In order to guarantee the accuracy the static test is made with calibrated weights. For this purpose, the weigh hopper is fitted with a frame on which the calibrated weights can be placed. It is obvious that this verification requires a tremendous work particularly when the bulk weigher is in the higher capacity range. Care should be taken when installing the bulk weigher that it is easily accessible and that suitable handling equipment is available for the calibrated weights. In case the frame is detachable from the weigh hopper zero setting must be possible with and without the frame in place.

The bulk weigher can also be designed to have built-in air operated test weights which make the verification much easier. In practice, however, these systems are generally applied on bulk weighers of small and medium capacity. They cover either the full weighing range or only a fraction of the range. If they cover only a fraction of the range it is necessary to use the successive method which is in any event commonly accepted for the high capacities. The substitution loads are normally made up from the material to be weighed.

The error limits for the static test (Fig. 6) of a discontinuous totalizing automatic weighing machine are generally the same as for the same capacity non-automatic weighing machine and as specified in the OIML Recommendations as follows :

- ± 0.5 d for loads up to and including 500 d,
- ± 1.0 d for loads over 500 d up to and including 2 000 d,
- ± 1.5 d for loads over 2 000 d.

The rounding error depending upon the scale interval of the digital indicator has to be assessed.

The verification is considerably facilitated by the auxiliary indicator in the lower right hand corner of the screen that gives an actual weight at any time, or only during calibration in some countries. This indicator can be selected to a resolution that is ten times higher than the totalizer resolution and permits, therefore, direct reading of the scale load in units of 1/10 of an increment and to establish in a very simple way the linearity deviation (static error). Systems without this feature are subject to checking with test weights in the amount of 1/10 of the totalizer interval in order to determine the trigger point for the indicator in all static load steps as well as in the tests with material in automatic operation (Fig. 6).

The tests in automatic operation are intended to determine the behaviour of the bulk weigher under the influence of the moving material and the other usual operating conditions. The maximum permissible error limits must, therefore, take into account such influences. In practice, it has been found that a maximum error of plus or minus 1.25 grams per kilogram of load as specified in the F.R.G. can be complied with in most cases. The maximum error of plus or minus 2.5 grams per kilogram of load also admissible in the F.R.G. is rarely practised since it is felt that the technical effort is not justified for this reduced accuracy.

The calculation of the maximum permissible error must consider the rounding error depending upon the scale interval of the digital indicator ; it is applicable only once for each weighing transaction.

In order to establish a reference for this accuracy it is necessary to determine the minimum quantity that has to be weighed in one transaction. Therefore, the quantity of material passing over the bulk weigher during its test in automatic operation must equal this minimum transaction quantity. It is fixed in terms of a minimum number of individual discharges to be made, the total of which must correspond with the minimum transaction quantity. The minimum number can be one or several discharges. The lower limit is generally expressed in terms of a multiple of the totalizer interval.

It is, in fact, important to be able to accomplish the minimum transaction quantity in one discharge in order to satisfy the needs of certain industries (feedstuffs, coffee, etc.) for recording the individual ingredients of a mix that has been batched by the bulk weigher. Of course, the weigher must be checked accordingly and comply with the error limits that apply.

The tests in automatic operation are made in several stages. One of which is made with draft weights that equal the minimum capacity, another with draft weights that are close to the maximum capacity and a third run with draft weights that equal an intermediate load of the bulk weigher. Each series must consist of a number of discharges whose total weight is the minimum transaction quantity in kg or in t as well as by the number of drafts.

Example :	maximum capacity	1 000 kg
	minimum capacity	300 kg
	minimum transaction quantity	1 000 kg in one batch

The tests are made in three series :

4 batches of	300 kg each	=	1 200 kg
2 batches of	500 kg each	=	1 000 kg
1 batch of	1 000 kg	=	1 000 kg

In automatic operation, the discontinuous totalizing automatic weighing machines are normally checked with the material they are intended for. In many cases they are located in the building or integrated in the material handling process where it is very difficult to collect the material weighed and pass it over an additional checkweigher. Such a checkweigher of suitable capacity and accuracy is often not available or difficult to obtain.

Therefore, it is usual to reweigh the weighment made in automatic operation by the bulk weigher itself. This assumes that the bulk weigher is sufficiently accurate and linearity deviations found during the static test are known and can be taken into account during these tests.

Again, the expanded indicator resolution is of great help in this test procedure. However, since this method only checks one weighment at a time, it is necessary to totalize the individual batches in the test report until the minimum transaction quantity is reached.

In order to ensure that the test is made under realistic operating conditions, every weighment to be checked has to be preceded by one or several automatic cycles that are not checked so that the air will be in full circulation. For the same reason, elevators, compressors, dust collection systems and other equipment producing eventual vibration or other disturbances must be in operation in order to see their influence on the accuracy of the bulk weigher.

The test procedure is normally as follows :

1. Start operation in automatic mode.
2. Discharge one or several drafts in order to establish usual operating conditions.

3. Halt the automatic cycle by the « CHECK STOP » key which enables the weigher to stop with the weigh hopper full after the weight has been automatically recorded by the totalizer or by the printer.
4. Determine the trigger point for the indicator by applying test weights in the amount of 1/10 of the totalizer interval or take a direct reading from the auxiliary indicator after the installation has fully settled.
5. Initiate automatic discharge and halt the weigher by the « CHECK STOP » key with the weigh hopper empty after the weight has been automatically recorded by the totalizer or by the printer.
6. Determine the trigger point for the indicator by applying test weights in the amount of 1/10 of the totalizer interval or take a direct reading from the auxiliary indicator after the installation has fully settled.
7. Repeat operations 1 through 6 until the number of weighments checked corresponds with the minimum transaction quantity.

The analysis of the results is as follows :

8. Totalize all weights recorded in automatic operation (difference between 3 and 5).
9. Totalize all weights determined in fully stabilized situation (difference between 4 and 6).
10. The difference between the totals 8 and 9 must not be greater than the maximum permissible error in automatic operation after deducting the deviations found in the static test for the pertaining individual draft weight multiplied by the number of discharges made for this transaction.

Typical results of a verification according to this scheme are shown in Table 1.

ROYAUME-UNI

TESTING of AUTOMATIC RAIL-WEIGHBRIDGES

by Roger ROBINSON

National Weights and Measures Laboratory

SUMMARY — This article is an adaptation of a presentation given at the OIML Seminar for «Testing of Bulk Weighing Installations » in Paris 22-25 April 1985.

Many articles have been published over the last fifteen years on « in-motion » weighing both for general applications and more specifically applied to railway weighbridges. At the time of writing, the application of « in-motion » weighing to railway weighbridges is under consideration by an OIML working group with the intention of producing a draft International Recommendation. Most previous publications have biased towards the valuable theoretical considerations of the dynamic weighing process. This article includes a discussion of the practical aspects of testing and test procedures as experienced in the UK.

RESUME — Cet article est basé sur un exposé présenté au Séminaire de l'OIML sur le Contrôle des Installations de Pesage en Vrac, Paris 22-25 avril 1985.

Alors que beaucoup d'articles ont été publiés sur les aspects théoriques du pesage des wagons en mouvement, cet article traite des aspects pratiques de la vérification de ces installations qui sont actuellement à l'étude par un groupe de travail de l'OIML. L'auteur résume en particulier l'expérience du service métrologique du Royaume-Uni dans ce domaine.

Introduction

Automatic rail-weighbridges (ARWs) are a category of weighing machines for which an International Recommendation has recently been proposed under OIML working group SP 7-Sr 5. The proposal describes railway weighbridges designed to weigh wagons while they are in-motion and includes machines dedicated to weighing uncoupled wagons as well as those capable of weighing complete trains of coupled wagons. « In-motion » weighing for trade purposes in the UK has been restricted (through user demand) to coupled wagons and consequently the knowledge and experience of UK metrology authorities is similarly restricted. So, dealing solely with coupled wagon weighing on ARWs, this paper gives a reflection of procedures for and problems of testing an installed machine.

As this type of weighing is relatively novel the paper begins with background notes and related discussion to aid comprehension of the levels of integrity and performance expected. Accordingly the following headings have been adopted :

- 1 Evolution
- 2 Classification
- 3 Traceability
- 4 Static testing
- 5 Verifying the mass of test wagons
- 6 Motion testing
- 7 Summary

Some of the terms used are peculiar to ARWs and others have a meaning specific to these machines. Figures 1 and 2 illustrate some of the following terms :

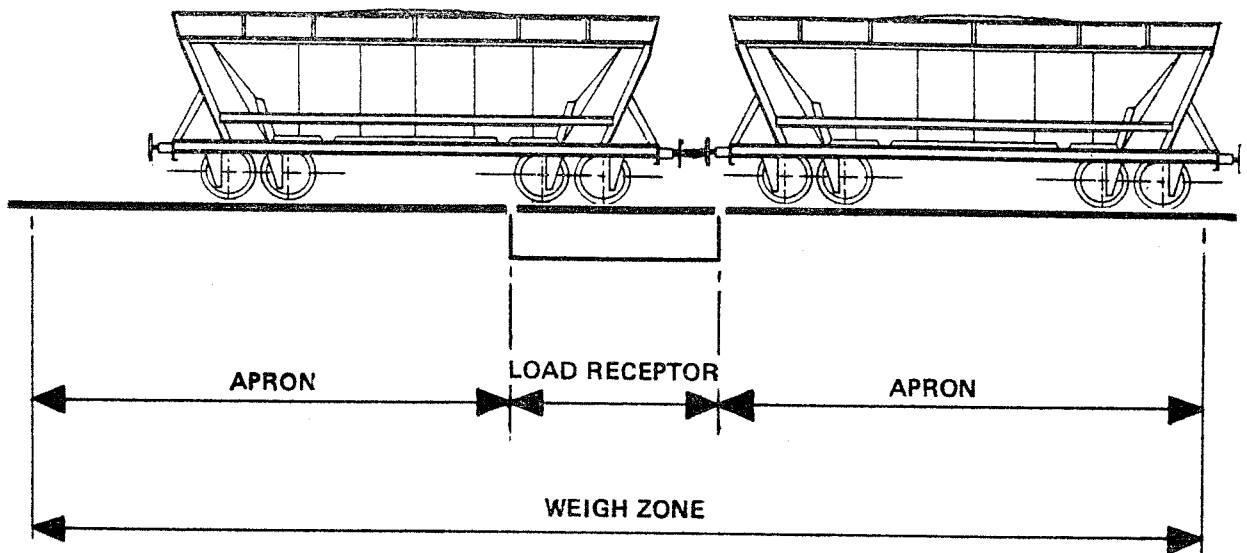

Figure 1 — Partial weighing

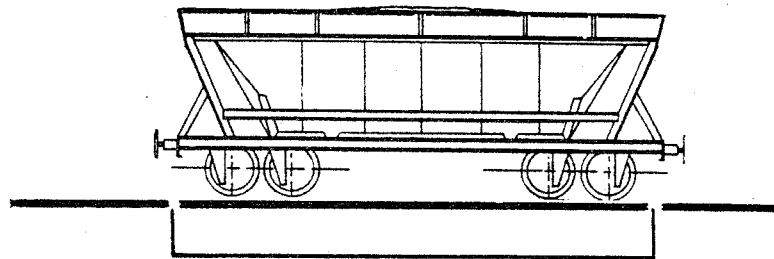

Figure 2 — Full draught weighing

partial weighing applies to single or bogie machines on which each half of a wagon is weighed separately and the two results automatically summed,

aprons refers to approach and exit rails which though not giving information on the mass of the wagons are nevertheless part of the ARW,

full draught weighing applies to the process of weighing a wagon in a single operation and is therefore the alternative to partial weighing,

static testing is the process of verifying a control machine (*) using standard weights and does not apply to the verification of the mass of a wagon used subsequently for motion-testing.

1 Evolution

Experience in the UK of approving patterns of ARWs and their subsequent verification dates back to about 1965. However, in retrospect their arrival seems somewhat tardy considering we have a report [1], dated 1910, of in-motion weighing trials on a non-automatic railway weighbridge. An example of a mode of operation awaiting the march of technological progress before adoption.

One of the fundamental needs for motion weighing in the UK, is that of weighing coal delivered to power stations to generate electricity. To weigh correctly on non-automatic weighing machines the wagons must be stationary and uncoupled. This restriction justifies in-motion weighing :

firstly by enabling a weighing operation in a time period which is compatible with the needs of the industrial process and

secondly by providing that service to a « known » order of accuracy.

When used correctly, non-automatic weighing machines are capable of weighing to an order of accuracy better than that of in-motion weighing but if a machine is abused its order of accuracy becomes unknown and its value and integrity are nullified. The conclusion was : it must be preferable to have a known accuracy of an inferior order than to have an unknown accuracy. On a non-automatic weighing machine even a pneumatic coupling between wagons will cause erroneous weighings. Alternatively, uncoupling and subsequent coupling involving constant shunting of weighed and unweighed wagons is far too time consuming. A power generating station might receive say 30 000 tonnes of coal by rail in one day. Such a quantity could require the use of 1 000 wagons and consequently the correct use of a non-automatic weighing machine would not be compatible with the average time available to weigh each wagon. The further complication of disparate time intervals between the arrival of consecutive trains would cause an intolerable build-up of rail traffic. The above figures can vary considerably with the size of the power station and with the capacity of the wagons but the nature of the problem remains unchanged. So clearly in these situations it would be impracticable to employ non-automatic weighing machines. The type of metrological instrument chosen must be suitable for the required manner of use and in accord with the industrial processes. If not, the metrological requirements might tend to be ignored, for instance by varying degrees of deceit, and machines will be abused. Traceability would then be lost and the resulting accuracy becomes unassignable.

In the above example the contracting parties wanted to know only the total weight of coal delivered over a given period. The smallest bulk quantity required was that of the train-load and initial trials proved that a summation of the results of weighing individual wagons tended towards acceptable errors on a total train load. Such levels of integrity were due to the occurrence of compensatory errors on individual wagons. Errors of 0.15 % of total train net weight could be achieved by

(*) OIML RI 50 - Continuous totalizing automatic weighing machines, section 3.4.7.

sacrificing speed and through greater attention to construction of the load receptor and adjacent rail foundations. Such systems were ideally suited for merry-go-round installations (MGR's), as illustrated in Figure 3, and suitable requirements were adopted after many years of exploratory site tests. Meanwhile, the concept of in-motion, whole train (Total Train) weighing was adopted for other transactions provided an entire train load was intended for a single customer at a single destination.

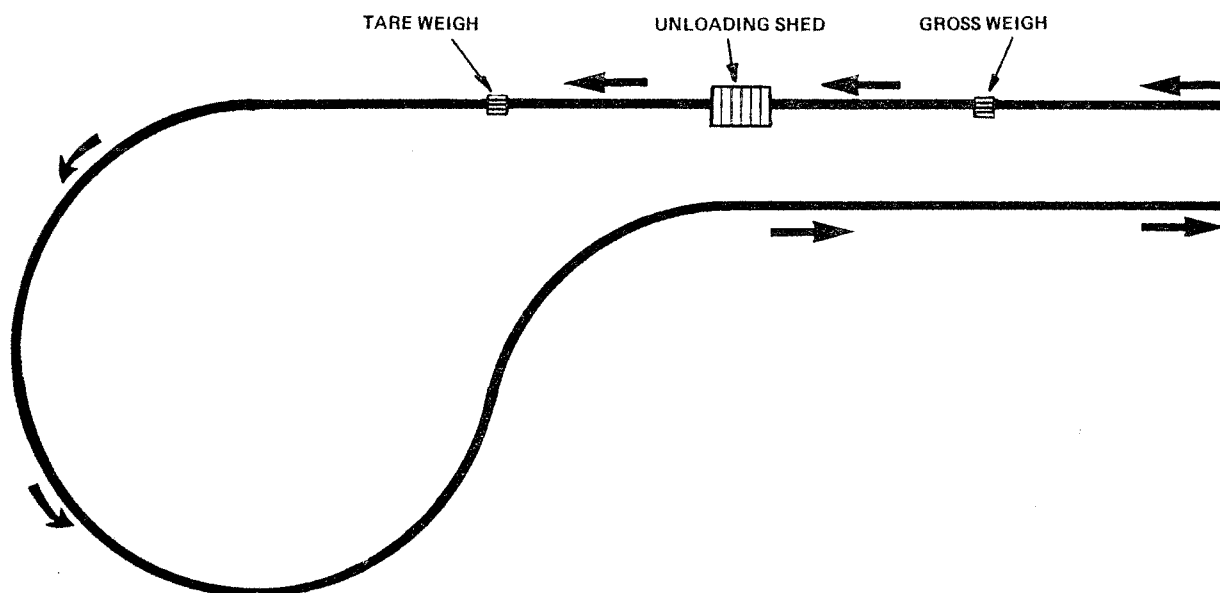

Figure 3 — Merry go round (MGR) system

As a large proportion of train loads of all types are split between two or more customers the demand for a similar application to individual wagon weighing with associated indication and printout was accepted along with appropriate metrological standards. Application was extended, for example to weigh 800 tonne vehicles.

2 Classification

A title like « in-motion railway weighbridges » might imply that the load receptor moves while it is weighing or that it can weigh movement. However, the choice of the adopted title « automatic rail-weighbridges » (ARW) was also made to emphasise the separation of ARWs as a group from non-automatic weighing machines. The prefix « automatic » both reflects their manner of use and epitomises the type of instruments dealt with.

These machines have their origins in the non-automatic category but for speed and convenience the current patterns must perform in a manner analogous to an automatic machine. Though there is a body of opinion which would prefer an accuracy related to non-automatic weighing machines, if they are to be used in the manner required by owners and operators, such a level of integrity would appear to be unachievable during the foreseeable future. If this is unacceptable to the parties involved in a transaction, then the alternative is to resort to the use of non-automatic rail-weighbridges. But if these are used incorrectly they will not indicate mass to an integrity implied by the appropriate maximum permissible errors for non-automatic weighing machines.

The demand for non-automatic accuracy during testing will be invalid if the aims of that test are regardless of the subsequent manner of use for that machine.

A further distinguishing feature which aligns ARWs with certain other forms of automatic weighing is the potential totalisation of mass (i.e. bulk to bulk) of quantities in excess of a specified maximum capacity. In the case of ARWs this is not only due to the possibility of totalising the loads of wagons but also of axles or bogies. So, in common with requirements for other types of automatic weighing machines many metrology authorities have related the maximum permissible error to the weight of the bulk material instead of the maximum capacity.

3 Traceability

The test procedure is divided into parts and the purpose of each part is to link the traceability of the machine from standard weights to the manner of use.

The motion-testing which culminates the test procedure is the easiest part of the test, it takes only minutes to complete a test run and so a sufficient number of runs should be demanded to investigate the effects of :

- (1) changing speed ;
 - (2) changing direction ;
 - (3) changing the number of wagons ;
- and (4) a full range of wagon loads.

Such a set of results for motion weighing should be representative of normal use.

To assess these results the mass of the test wagons has to be declared to an accuracy which is an order better than that required for motion weighing to avoid significant compounded errors. The factor of 3 as recommended for the verification of weights for testing non-automatic weighing machines (*) may be sufficient for this application provided the control machine is verified in the first stage of the test.

The alternative proposal is to adopt the larger factor of 5 as required of the control machine for a beltweigher (**). The opposing argument to this puts the case that because the control machine for an ARW (which will likely be the same machine) has to be verified as part of the test in question it should not suffer loss of accuracy due to time and wear. This would not necessarily be true in the case of beltweighers according to IR 50.

Whichever accuracy ratio is chosen to relate an ARW to its control machine, it follows that the latter must be a non-automatic weighing machine and operated as such in order to achieve the appropriate resolution.

The control machine used for verifying the mass of the test wagons has also to be verified to the next higher level of accuracy. The denominations of the standard test weights used for this purpose are usually one-tonne or half-tonne with much smaller weights to find rounding errors on digital scale intervals.

To complete the traceability hierarchy requires confirmation of the accuracy of the test weights to the next appropriate level which may be evident by either a stamp on each weight accompanied by a date or a certificate of accuracy.

A reversal of the above traceability stages presents a list inclusive of the test procedure :

- standard weights ;
- static testing ;
- verifying the mass of test wagons ; and
- motion testing

(*) OIML RI 3, section 10.1.

(**) OIML RI 50, section 6.4.2.

4 Static testing

The above list could be extended to emphasise the traceability of standard weights (*) in consideration of the relatively high rate at which their mass will vary with time and use. Such large weights are particularly susceptible to wear and tear. Due to the large size and appearance of one-tonne weights they may be badly handled compared to, for example, boxed weights of class M2. An operator of mechanical handling equipment needed to move a one tonne weight might not have heard of metrology and this may result in the need to dig the weights out of the ground before use or such adverse practice as swinging them against a wall as guidance prior to placement.

The standard weight is the most accurate item of equipment to be used in the entire test procedure and should be duly respected. In particular it must be protected from mishandling by untrained persons.

The static testing should then proceed in similar fashion to that of the non-automatic weighing machines (**). To enable these procedures, some prior consideration should have been given to the position of the weighbridge regarding its accessibility for vehicles capable of moving the large standard weights. The use of standard railway test-trolleys used in some countries to support the test weights on the weighbridge is an aid to rapid loading and unloading of the weighbridge enabling assessment of repeatability and relatively easy setting of span and zero. Despite these advantages there may be problems in universal adoption due to consistent use and the practicalities of supply and availability.

In common with other high capacity weighing machines which might be permanently installed outside of a building, the static testing is subject to environmental disturbances which in extreme conditions may require the verification officer to negate the validity of the test. Obvious factors are wind and rain, particularly if the latter causes water to collect on badly designed standard weights or to ingress other test material (substitution mass). Ice can be a worse enemy of integrity because it does not require hollows in which to build-up and its presence might not be readily noticeable. (Low temperature can be a deterrent to adequate vigilance and inspection.)

5 Verifying the mass of test wagons

The next stage is to weigh test wagons whilst uncoupled and stationary (static wagon weight) to an accuracy adequate to assess the subsequent motion testing results.

Having adopted a suitable train for testing (see section 6) a control machine is required to verify the mass of the test wagons. As mentioned previously under « traceability », the control machine will have to be a non-automatic weighing machine and the ARW under test is usually designed and constructed in such a manner that it can be used as such. This usually requires switching to a « test mode » to achieve the appropriate resolution. (The author is unaware of any alternative arrangement ever having been used in the UK).

If this is the case, the procedure for verifying the mass of the test wagons will depend upon whether the machine operates by full draught weighing or by partial weighing.

5.1 Full draught weighing

In its simplest form static wagon weighing requires a machine having maximum capacity and length to weigh each wagon while entirely supported by the load

(*) OIML RI 47 - Standard weights for testing of high capacity weighing machines.

(**) OIML RI 3 and RI 28.

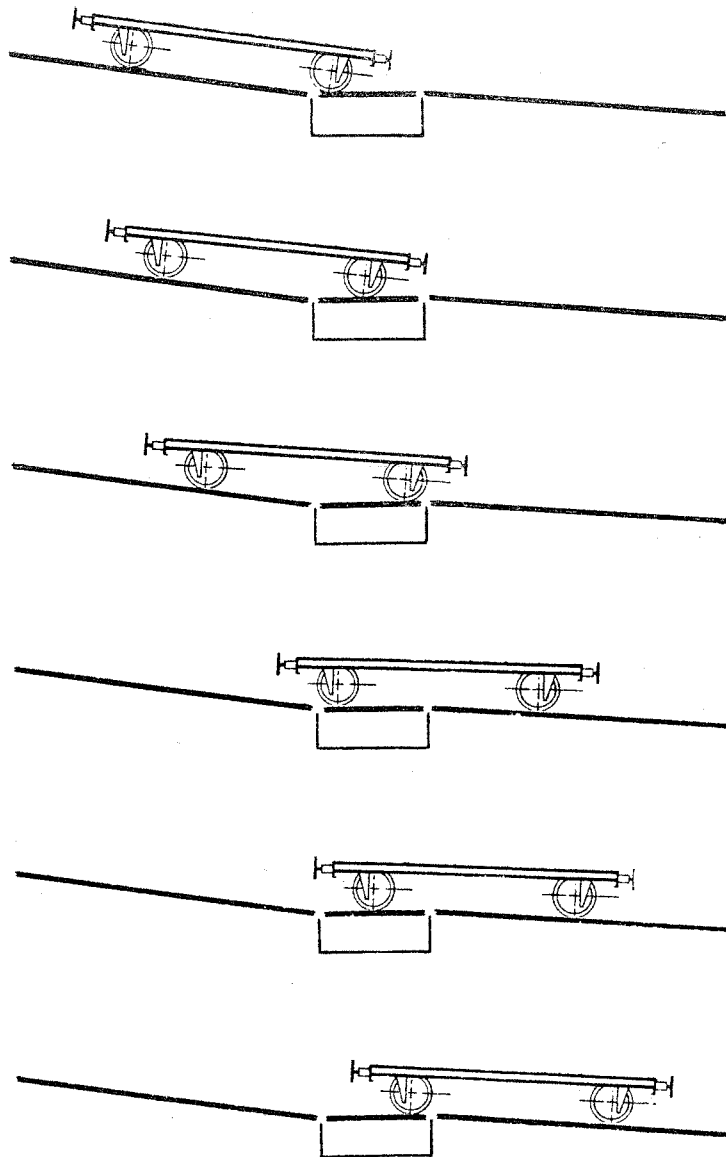

Figure 4 — Partial weighing calibration procedure

receptor. If the ARW operates by full draught weighing and if it can satisfy the requirements of « static testing » (see section 4) to ensure the traceability of the entire test procedure the ARW can be used to check itself. Though this statement may inspire a natural aversion it can be justified by the different type of use which separates the two levels of accuracy under consideration. A manner of use associated with static wagon weighing and a manner of use associated with motion weighing.

5.2 Partial weighing

Partial weighing meets with general disapproval particularly when applied to non-automatic machines. However, the demand to apply this to ARWs in the UK is such that it has long been considered grossly uneconomic and unreasonable to require a second weighing machine which might only be used during testing. So partial weighing for static wagon weighing is allowed provided the machine can satisfy additional requirements which should alleviate the disadvantages of partial weighing ; including :

- (1) the possibility that the inherent error, though acceptable in a single weighing operation, will be doubled on addition of axle or bogie weights of a single wagon, and then exceed a permissible level ; and
- (2) any variation of inclination between the load receptor and each apron will also vary the height of the centre of gravity for each partial weighing and this will in turn cause the moment about each axle to vary between each partial weighing. The effect of this might never in itself cause unacceptable errors but all effects can be cumulative.

5.3 Partial weighing calibration procedure

To nullify the above and any other effects due to partial weighing without demanding far stricter limits of error which may mean an impracticably large number of scale intervals the UK has been using a procedure involving standard weights and a wagon capable of supporting them. The wagon is weighed with and without the standard weights and a subtraction should equate with their total mass. Any discrepancy can then be used to adjust the results of the static wagon weighing process.

This correction procedure is by no means perfect but having adopted it we try to optimise its validation by weighing each axle at end, middle and end of the weightable as shown in Figure 4. This gives six weight indications which when summed and divided by three is representative of the vehicle. The procedure is then repeated with the test weights evenly distributed on the wagon. The subtraction of indicated tare weight from indicated gross weight when compared with the total standard weights on the wagon then gives a correction to be used when static wagon weighing.

5.4 Defects in the calibration procedure.

The following identifies two particular problems associated with this procedure :

- (1) the wagons used in the test train might not be constructed to support test weights. So a suitable wagon has to be found having a similar wheelbase. There can be difficulty in complying with this requirement ;
- (2) what criteria must be used to determine the quantity of standard weights to be used ? The wagon plus the standard weights should be related to the heaviest wagon weighed on the ARW when in normal use but with a lighter wagon the suspension is higher, the centre of gravity changes and so in theory will the appropriate correction factor. Experience has shown that calculations of moments about the centre of gravity of a wagon to find axle loads appear to be overridden by other factors, so further experimentation is desirable.

Despite this shortfall the UK has persevered with the partial weighing calibration procedure because it fills a hole in the traceability chain by linking the use of standard weights with the procedure for verifying the mass of test wagons.

There are schools of thought who favour waiving the partial weighing calibration procedure if alignment tolerances are applied to the rails throughout the load receptor and aprons (comprising the weighing zone). This attitude is not entirely satisfactory because it does not negate the compounding of errors due to partial weighing. Neither is this resolved by the initial static testing with standard weights because the manner of use is not sufficiently comparable and the traceability chain would be more tenuous. A call for both criteria would of course strengthen the traceability.

Whatever method chosen, a set of verified individual wagon weights is required against which the motion weighing results can be assessed.

5.5 Effect of windage in wagon mass verification

The major natural influence on testing is wind. Wind has some effect at the static testing stage, having greatest effect when the standard weights are stacked

to maximum capacity. However, the density of standard weights is relatively high and therefore the effect of windage is minimised. This is clearly not the case when weighing wagons. Wind may have the effect of shifting the wagon weight from one suspension to another so this will cause particular problems when partial weighing.

Full-draught weighing, the alternative verification procedure, does not entirely eliminate this problem because the wind may still cause some degree of lift. Though the wheels rarely leave the rails there may be sufficient lift to prevent the weight indication from stabilising. If the wind never drops to zero any reading of the weight indicated may be invalid. The unfortunate geographical siting of a machine in such features as cuttings which form wind-tunnels will exacerbate the problem, as might the extreme alternative of an exposed position. In such circumstances quite modest weather conditions will prohibit a stable reading. The lessons here are to take such factors into consideration when the site is chosen, bearing in mind an inspector may have to use his discretion by deciding whether such conditions on a given day will invalidate testing. Furthermore, if excessive inaccuracies are a consequence of such disturbances, should the inspector be given a mandate to refuse to verify the ARW on the grounds that the site is susceptible to such conditions ?

6 Motion testing

For motion testing, if the weighing procedure for stationary uncoupled wagons has been followed, the test train will now be available to complete the rest.

The test train must typify those trains to be weighed on the ARW when in normal use. Many parameters will directly affect each weighing operation and as many as possible must be assessed. For example, with a conventional hook and chain coupling, if the wagons are being pulled then the tensions in the couplings will tend to cause each wagon to be either lifted off the rails or pressed onto the rails depending on whether the adjacent wagon either is carrying less load and is therefore higher on its suspension or is heavier and therefore lower on its suspension. This effect will tend to average out the wagon weights although of course the tension in the couplings will become progressively greater towards the front of the train. This unavoidable effect is contributory to the consistent inaccurate motion-weighing of the wagon attached to the locomotive. Alternatively, if the wagons are being pushed, the reaction between buffers may cause erroneous weight detection.

A train with relatively few wagons will have less inertia so it will be more responsive to speed variations which will emanate as jerks, causing chattering between wagons. This is detrimental to weighing accuracy because of the additional transient dynamic forces transmitted to the load cells.

The correct train length will also be required to ensure that the weighing operation is subjected to the effects of features such as rail-switchpoints, curves in the track, inclines and changes in inclines. These features can make either mischievous combinations or the effects may be compensatory so the results require appropriate examination. The effects of such features can also be aggravated by a bad wagon whose performance would defy the integrity of any such weighing machine, so again, appropriate assessment is required.

A bad wagon can be one which has flats on the wheel rim, brakes which stick, or any other misdemeanour which inhibits constant speed.

At the stage where the motion testing is all that remains of the exercise the most arduous tasks have been completed. It is comparatively easy and quick to do the motion testing by using the test train for an appropriate number of test runs. However, the validity of each of the test stages is interdependent, so it is imperative to justify the cost and commitment of resources by fully investigating the characteristics of motion weighing on the installation. The characteristics will include :

- (i) speed of the wagons during weighing. Each ARW should have a specified operating speed range. So a number of test runs may be needed to obtain a representative range of speeds. The installation may be adversely responsive to particular speeds due to perhaps the associated rail discontinuities.
- (ii) an interlock or overspeed cutout set at the maximum operating speed, above which no weight should be indicated. The tests should be used to confirm the repeatability and integrity of this cutout device. Taking prior note of the distances between the leading axles on consecutive wagons the author's method of assessment is no more sophisticated than taking note of the split time when each leading axle rolls off the load receptor (see Figure 5) and subsequently calculating the speed for each wagon. As the accuracy of this method will be inversely proportional to the speed of the wagon its deficiencies are obvious. More ideas would be welcomed. For those installations at which the overspeed setting is less than it need be, the repeatability of the setting is of little importance provided that every weight indication or printout is within the permissible limit of error. However, the manufacturer might have set the overspeed cutout in accordance with the minimum time required for the pattern to process the weight signal and so is regardless of site conditions. Therefore, such a test is required and if a test method can be validated and adopted, a comparison of errors and wagon speeds for each machine could then be used to determine an overspeed setting suited to a given installation.

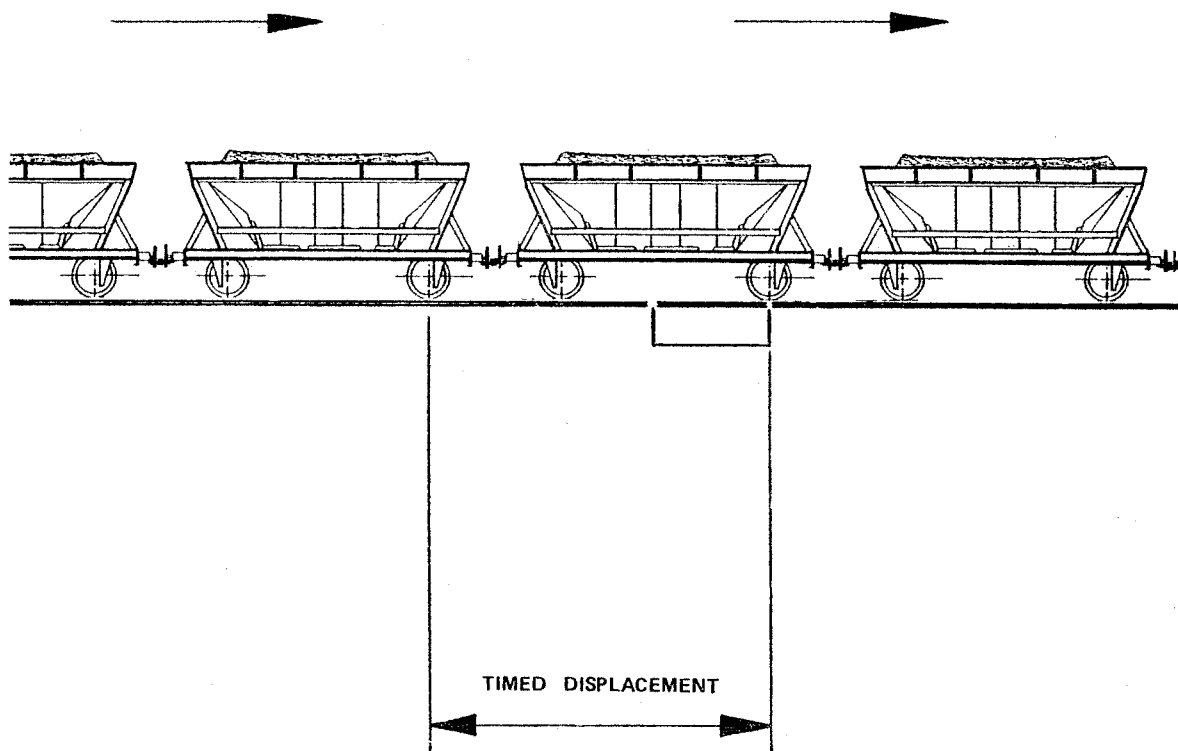

Figure 5 — Overspeed cutout test

- (iii) direction of the motion weighing. If the machine is to be used in either direction then motion testing must follow the same procedure.
- (iv) alternative tracks or sidings from which the train might approach the machine. The effect of any wagon being jolted by a feature on the track being used could be transmitted throughout the train. So if any wagon is on the load receptor at that moment or soon after, the weighing will be affected to some

degree. Therefore the test runs should include every alternative route which is within the length of a train from the load receptor and which may be used for a weighing operation.

- (v) the nature of the load in the wagons. This follows a previous emphasis of the importance of using the same material for testing as will subsequently be weighed during normal use and is particularly important in the case of liquid loads. This philosophy means that the nature of the load need only affect the specification for a particular installation which may need to be revised as a result of the test. This need will therefore not normally affect pattern approval. At this time we have only been able to verify equipment to weigh liquids under the following three conditions :
 - (i) the weighing is in full-draught fashion
 - (ii) the wagons completely contain the load
and
 - (iii) the wagons are either completely full or empty.

Whilst it is feasible to overcome the last requirement ; and the second being dependent upon the properties of the liquid and the design of the wagon ; the author cannot foresee a relaxation of the first condition.

7 Conclusion

At this point the practical and physical work involved in the test procedure has been completed. Normally the results of the static testing and of weighing stationary wagons are taken from the weight indication on the control panel whereas the results of the motion testing are normally taken from a printer.

The purpose of this paper has been to :

- (i) paint a personal view of some aspects of testing ARWs ;
and
- (ii) tie together the various stages in a manner which inspires the notion of traceability (as need be applied to all types of automatic weighing machines).

The latter is particularly important while the OIML international working group for automatic weighing machines is active. But while discussions continue with the aim of establishing a valid test procedure there also grows concern for a disproportionate verification cost. It cannot be denied that the cost of testing, inclusive of resources, equipment and personnel, will incur a four figure sterling value. However, ARWs will commonly weigh materials of equivalent value within hours and amply justify an annual test. The needs of an installation and its use should be re-examined if the verification cost appears incompatible with the value of material weighed between tests.

As example, the UK Central Electricity Generating Board consumes approximately 80 million tonnes of coal per year and the majority of this is weighed on ARWs. The cost of confidence in the measurement of this load within a modest 0.5 % must be considerably less than the potential cost of accepting a declaration of quantity without knowing its order of accuracy as would be the case with inappropriate test procedures. The confidence in a measurement, if quantified, would be very low if the test procedure for any weighing machine was heedless of the manner in which it is used. In observing this principle the current order of cost seems unavoidable. Future consideration for the justification of installing an ARW may be aided by the possible OIML adoption of a multi-tier accuracy system similar to that for non-automatic weighing machines.

Finally, any discussion of the supervision of these exercises would be incomplete without mention of the responsibility involved.

There will be moments of condensed activity separated by periods of relative calm all spread over two days or more. Considerable vigilance is required in supervising the operation involving personnel from the railways, the plant or premises, the machine manufacturer and other metrology staff. Equipment including many tonnes of test weights, crane, locomotives and rolling stock.

Though the supervisor will need to be alert to ensure the integrity of the exercise the obligation to health and safety must maintain priority. Although each task will normally be done by experienced persons a combination of the above resources and personnel from varied disciplines may mean that some of the people will be in an unfamiliar environment.

So although there must be concern for the metrological integrity of the test it would be irresponsible of any participant to be heedless of the considerable potential hazards in the process.

Reference

- [1] McQuown SH, Experimental Investigations into Railway Track Weighing made on the Clydebank. Standards Department, Board of Trade, 1910.

WEIGHING of COPPER CONCENTRATE

by David R.R. GOWDIE * and John van der LINDEN **

SUMMARY — The following article was presented at the OIML Seminar on Testing of Bulk Weighing Installations in Paris 22-25 April 1985.

Careful sampling and analysis allow Bougainville Copper Limited to compare the results of total contained copper of copper ore shipped with the values obtained by its customers (smelters) and thus indirectly discover differences between weighing of shipments on departure and at arrival and when necessary obtain readjustment of the weighing equipment. Economic losses due to weighing errors could thus be limited to 0.1 % over a period of ten years.

The method of testing the 20 t hopper scales used by the producer is also described.

RESUME — L'article suivant a été présenté au séminaire de l'OIML sur le Contrôle des Installations de Pesage en Vrac à Paris les 22-25 avril 1985.

Un échantillonnage correct suivi d'analyses permet à la société Bougainville Copper Limited de comparer les résultats pour le total de cuivre contenu dans le minerai avec les résultats obtenus par les clients fondeurs et de découvrir ainsi indirectement d'éventuels écarts entre le pesage du minerai au départ et à l'arrivée et si nécessaire obtenir le réajustement des installations de pesage. Les pertes économiques dues aux erreurs de pesage ont ainsi pu être limitées à 0,1 % sur une période de 10 ans.

La méthode de vérification des bascules à trémie de 20 t utilisées par le producteur est également décrite.

1 Copper Concentrate and International Standards

1.1 — The International Organization for Standardization (ISO) in 1983 established its Technical Committee TC 183 on « Copper Lead and Zinc Ores and Concentrates ». At its first meeting ISO/TC 183 recognised that there was little point in attempting to achieve accuracies of the order of 0.1 % or better for assays, moisture determinations and sampling, unless similar accuracies were achieved in practice in weighing ores and concentrates.

1.2 — It is generally accepted that weighing equipment used with copper or other ores and concentrates should be subject to formal inspection and verification by Legal Metrology authorities. Unfortunately and inevitably such checking can occur only at discrete intervals, typically once each year, and usually taking place in static rather than operating conditions, not necessarily representative of loading or unloading concentrates. The actual practice of bulk weighing tends to be left to the individual company.

Guidance is needed in respect to the kind of equipment suitable for specified accuracies, to how in-service checks of weighing equipment should be made, and to what factors can cause inaccuracies in operational conditions.

* Executive Director, National Standards Council, P.O. Box 3042, Boroko, Papua New Guinea.

** Chief Chemist, Bougainville Copper Limited, Panguna, North Salomons Province, Papua New Guinea.

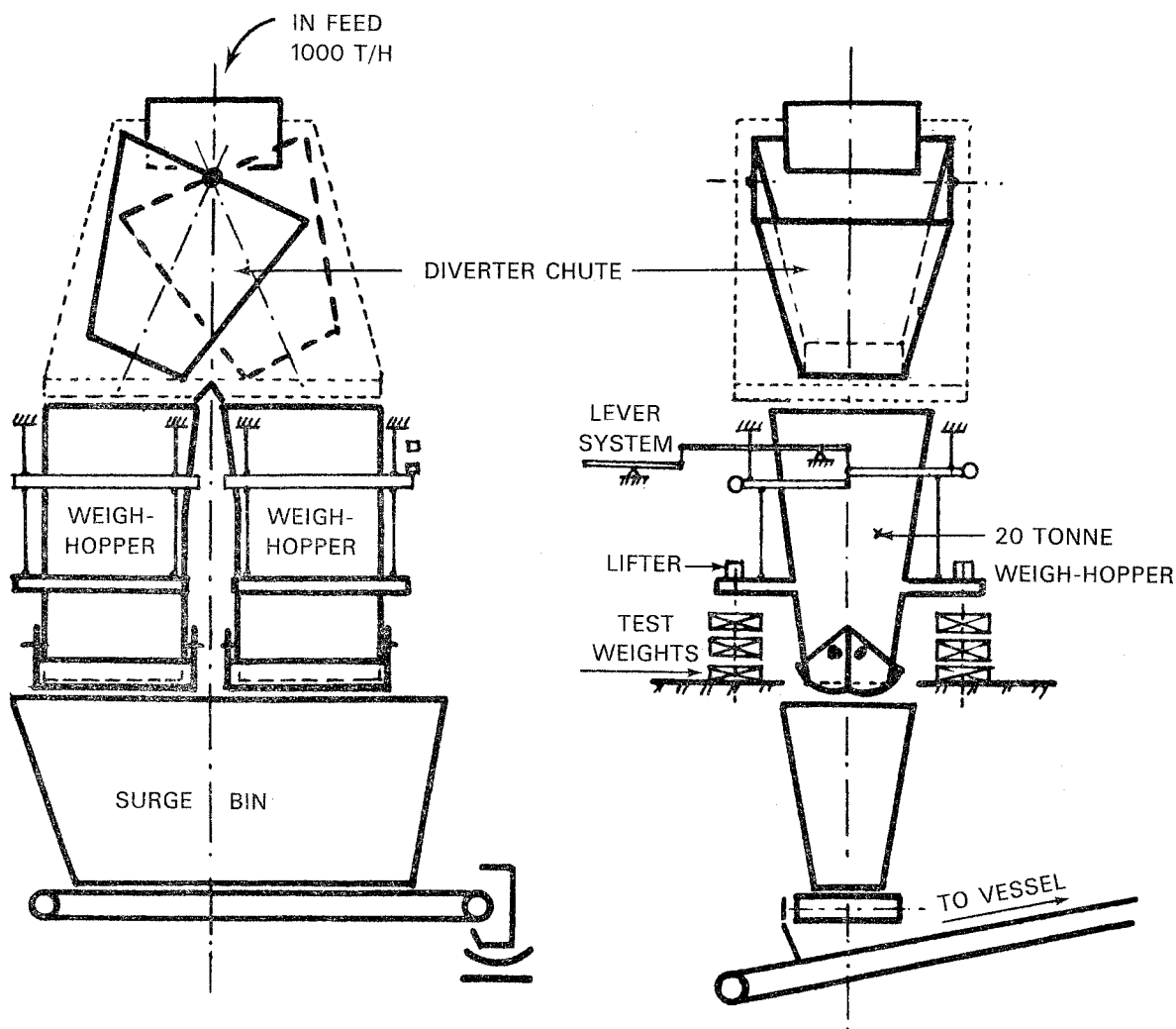

Fig. 1
Port batch-weighing system used by Bougainville Copper Ltd

1.3 — The nature of copper concentrate is such that its chemical composition changes between the time it is loaded on board ship and the time it is discharged weeks later to the smelter. In general the proportion of moisture decreases and so the wet weight tends to decrease somewhat during shipment. On the other hand copper concentrate oxidises and so dry weight increases. Thus it is not sufficient to compare wet weight shipped and wet weight received: sampling and assaying are required to determine the total contained copper (and also the gold and silver which may be present in much smaller proportions but together have comparable value). Some differences for contained metal can be expected between shipper and smelter, due to difference in weighing sampling and assaying techniques and small handling losses. However if a shipper has built up confidence over many years due to good agreement with his regular buyers, a significant difference in contained metal with a new buyer or even a regular buyer can be taken as an indication of something being amiss - possibly related to weighing. Percentage errors can be small but financially significant due to weighing problems, or large and financially extremely serious, as for example if a concentrate shipment were transhipped to barges, and a barge were lost en route to the smelter and/or its contents were not counted in totalling the weight of the shipment.

2 Papua New Guinea and Legal Metrology

2.1 — Papua New Guinea (PNG) is situated to the east of Indonesia and to the north of Australia from which it gained political independence on 16 September 1975. Islands, mountains and swamps comprise much of its area of 460 000 sq km. Most of its population of 3.3 million still live in largely traditional ways, supporting themselves by subsistence agriculture, hunting and fishing. The modern sector of the economy includes the growing of cash crops such as coffee, cocoa, copra, rubber, tea and cardamom, forestry and fisheries, and particularly mining. Bougainville Copper Limited (BCL) established on the island of Bougainville a large open cut copper mine which commenced production in 1972 and which still contributes almost half of PNG's export earnings. A new mine near the Indonesian border established by Ok Tedi Mining Limited has recently started producing gold, with copper expected to follow later this decade.

2.2 — The need for a Legal Metrology service was recognised in PNG prior to independence. The service is currently located administratively within the Standards Division of the Department of Industrial Development. The Standards Division is also responsible for the National Standards Laboratory which maintains a number of measurement standards, including mass, traceable to international standards. In addition to testing industrial weighing and measuring equipment, Standards inspectors perform consumer protection functions such as the testing and stamping of shop scales and fuel pumps, and the checkweighing of packages and bread. Inspectors also test scales for the trade measurement of coffee, cocoa, copra, etc. Within the Standards Division high priority is given to ensuring accurate measurement of export commodities.

3 Bougainville Copper Limited's Hopper Scales

3.1 — Bougainville Copper Limited (BCL) operates a large mine by world standards : the value of its production fluctuates, according to gold and copper prices, around US \$ 500 million. As justified by its large output the company from the start invested heavily in weighing, sampling and assaying facilities. In these operations the BCL approach has always been to seek the technically correct rather than the « commercial » answer. This has allowed effective control over product quantities sold and encouraged confidence among buyers. Initially twin 20 t × 10 kg mechanical hopper scales (see Figure 1) were installed at the company's ship-loading facility which can load over 1 000 t/hour. The scales were fitted with hydraulically operated cast-iron test weights of approximately one third, two thirds and full capacity. In 1982 the mechanical headwork for each hopper scale was paralleled by a single loadcell with electronic readout. After a trial period during which some shipments were measured using the mechanical and some with the electronic headwork, all measurements were made using the loadcells and electronic readouts. Recently for each hopper scale a second independent loadcell (under the same tension as the first but with independent readout) has been added to provide redundancy for the headwork. It should be noted that the lever systems have proved very reliable, as have the loadcells and electronic readouts.

3.2 — The BCL hopper scales are serviced every six months and a planned maintenance program is followed for mechanical components. Experience has shown that this frequency of servicing ensures very reliable operation. The scales are carefully checked against the test weights every month or so, between rather than during shipments. This allows any drift in the scales to be detected well before they go out of tolerance. After servicing the scales are reverified by a Standards inspector using 20 kg handweights and the hydraulically operated test weights. Each two years the 20 kg hand-weights are cleaned and repainted, and are then reverified by an inspector. The hydraulically operated test weights are also retested by comparison with the handweights. It should be noted that reverification of both hopper scales and the test weights requires a high degree of cleanliness as copper concentrate is a fairly fine powder which tends to settle on any horizontal or near-horizontal surface but which can be fairly easily and unpredictably dislodged.

To allow a scale to be reverified a platform is placed inside the hopper. The zero is set and then a 10 kg weight is added to defeat the zero - tracking circuitry. Small weights (1, 2, 3 ... kg) are added until the readout switches up from 0.010 to 0.020 tonne. If, as usually happens, this occurs when 5 kg has been added, the zero is known to be correct within 1 kg. When fifty 20 kg weights are placed on the platform (and the 10 kg removed) the readout shows 1.000. Small weights are added again until the readout switches up from 1.000 to 1.010. The third decimal place can be calculated by this process even though the readout always displays zero. This process is made practicable by the high sensitivity and small hysteresis in the system, and by the fact that the hoppers are protected from the wind.

The same process is repeated for known loads of 2.000, 3.000, 4.000, 5.000 and 6.000 tonnes, and with the aid of the hydraulically operated test weights, up to full capacity. The difference between known loads and calculated readouts typically does not exceed three kilograms over the range of the measurements. The in-service checks between shipments mentioned above indicate that this order of accuracy is maintained between government reverifications.

3.3 — Checking of the hopper scales is carried out in four ways during and after loading. The first, and by far the most important, is by applying the test weights before, several times during, and at the completion of loading. Any significant difference from the known values of the test weights can be investigated immediately. The second check is a belt weigher on the final conveyer from the hopper scales to the ship. Several times during each shipment a comparison is made between hopper scale and belt weigher results. The third method is by comparison with the draft survey before and after loading. It should be noted that a primary purpose of draft survey is to ensure a vessel's safe loading condition. A comparison of draft survey and static weight results is shown in Table 1 for one ship only. Results for different vessels are worse : over two years the mean difference was 0.3 % with standard deviation twice that. A fourth way, which in practice acts more as a check on buyers' scales, is the comparison of contained metal results as described below.

4 Contained Copper Results for BCL and its Customers

4.1 — In principle, determination of the contained metal in a shipment requires three separate measurements : the wet weight, the moisture content and the metal grade. The last two are dependent on careful sampling which must take place at the same time as the weighing. This is because the moisture content generally decreases due to oxidation after weighing and loading. Table 2 demonstrates how the total metal content should remain constant despite changes in both wet and dry weight.

4.2 — Historically BCL has achieved very good agreement (to 0.1 % contained copper) with its major customers as shown in Table 3. The (buyer minus seller) figures for contained metal compare with typical results for other producers of about —1 % for copper and minus several percent for gold. Details for shipments from BCL are shown in Figures 2 and 3. If an individual shipment or series of shipments shows a bias in contained metal results, BCL technical staff and/or consultants attend during the unloading of the next shipment. On occasions problems with sampling and/or assaying are found, the latter of particular significance for gold. On other occasions the problem concerns weighing, and three examples are given below.

5 Weighing Problems - Three Examples

5.1 — One smelter built a well designed concentrate discharge - weighing - sampling system which included a 25 t hopper scale. This automated system was fully enclosed, to prevent dust losses, by means of a canvas bag connecting the scale hopper to the receiving hopper. The system operated satisfactorily for a number of years until the decision was made to lower the delay time between weighings to improve throughput : the result was a weight loss of 0.5 % for contained metal for

Table 1 — Draft Survey Versus Static Weighing

Vessel Code	DS Minus Static Weight
J122	+ 62 t
J124	+ 8 t
J125	+ 48 t
J126	+ 10 t
J129	+ 22 t
J130	+ 65 t
J131	+ 45 t
J132	+ 28 t
J133	+ 45 t
J134	+ 62 t
J136	+ 41 t
J137	+ 30 t
J138	+ 45 t
MEAN	+ 39 t (+ 0.2 %)
STANDARD DEVIATION	19 t (0.1 %)

Table 2 — Changes of Weight During Transport

		SELLER	BUYER	REMARKS
Sampling Date		JAN 1	FEB 15	
Wet Weight	(t)	21 622	21 550	Evaporation loss
Moisture Content	(%)	7.50	6.73	Evaporation loss
Dry Weight	(t)	20 000	20 100	Oxidation
Copper Grade	(%)	30.00	29.85	Oxidation
Contained Copper	(t)	6 000	6 000	Constant

Table 3 — Shipped Versus Outturn Contained Metal
(BCL versus major buyers 1972-1983)

		SHIPPED	OUTTURN	RELATIVE DIFFERENCE
Dry Concentrate Weight	(t)	7 054 300	7 074 000	+ 0.28 %
Copper Grade	(%)	28.94	28.83	- 0.38 %
Contained copper	(t)	1 988 200	1 986 200	- 0.10 %

at least three shipments. The anomaly was noted from shipment statistics and during a visit to the smelter by BCL technical staff the reason was found :

Hot air from the concentrate in the weighing hopper caused the same effect as a hot air balloon, the inflated canvas bag counteracting gravity. The problem was solved by returning the delay time to its original value and fitting the canvas bag with vents. BCL now gets good agreement with this smelter. This sort of operational problem is unlikely to be noted during conventional reverification.

5.2 — A second example concerns a truck scale of 60 t capacity. Before adjustment under official supervision the scale underweighed by 1.5 %. Calibration after adjustment of the scale showed significant non-linearity so that the readout was about 30 kg high at 40 t (the weight of a loaded truck) and about 30 kg low at 20 t (the weight of an unloaded truck). The result was a bias in favour of the smelter of 0.3 %.

Part way through the unloading the scale was checked again using test weights, at the insistence of the BCL representative and contrary to usual procedure. A partial collapse of the platform had caused the bias to change from 0.3 % in favour of the smelter to + 5.4 % in favour of BCL. Weighing was stopped and agreement reached to base payment on shipped weights. Had the error not been detected the smelter would have overpaid US \$ 600 000 for the shipment.

5.3 — A third smelter had a two hopper system in which the weight recording equipment could be bypassed to allow the cleaning of blockages. However this resulted in significant amounts of concentrate not being weighed and recorded. The problem was compounded by an intermittent signal transfer problem from the scale to printout due to poor electrical components. Together these two factors caused a bias of about 1 % in favour of the smelter for four shipments. These problems were cleared up and subsequently good agreement has been achieved with that smelter.

It may be noted here that concentrate can be lost mechanically as well as due to poor weighing practice or equipment. For example if concentrate is allowed to lose too much moisture it may be blown off conveyer belts. Another possibility is that some concentrate may be left in the hold of a vessel : no attention to weighing practice could overcome this kind of problem.

6 An International Standard for Bulk Weighing Practice ?

6.1 — The accuracy needed in bulk weighing will depend on the nature and value of the product concerned, its quality and its homogeneity. An obvious first step is the choice of weighing equipment capable of the appropriate accuracy. A somewhat less obvious second step is ensuring that the equipment can be readily tested to the appropriate accuracy. This is important to facilitate not just periodic government reverification but also frequent in-house checking. A third step is to ensure that all material is actually weighed : for example hopper doors must be closed before filling commences and remain closed until weighing is complete. Similarly there should be no operational factors (such as insufficient delay after filling a hopper) to cause inaccuracies in the real weighing situation (as opposed to static reverification or checking).

6.2 — ISO/TC 183 has recognised the need for accurate weighing of the products with which it is concerned. Presumably similar problems to those outlined above have been experienced with bulk weighing of products other than copper concentrate. There may be codes of practice already in existence in relation to bulk weighing of particular products. In static reverifications of bulk weighing equipment accuracies of 0.05 % or better can be reasonably expected for modern equipment. But how can similar accuracies be ensured in operational conditions ?

Perhaps there is a place for an International Standard for Bulk Weighing Practice, one not limited just to copper lead and zinc ores and concentrates.

RELATIVE
DIFFERENCE
%

WET WEIGHTS : OUTTURN MINUS SHIPPED – MOISTURE LOSS/GAIN AND WEIGHING ERRORS

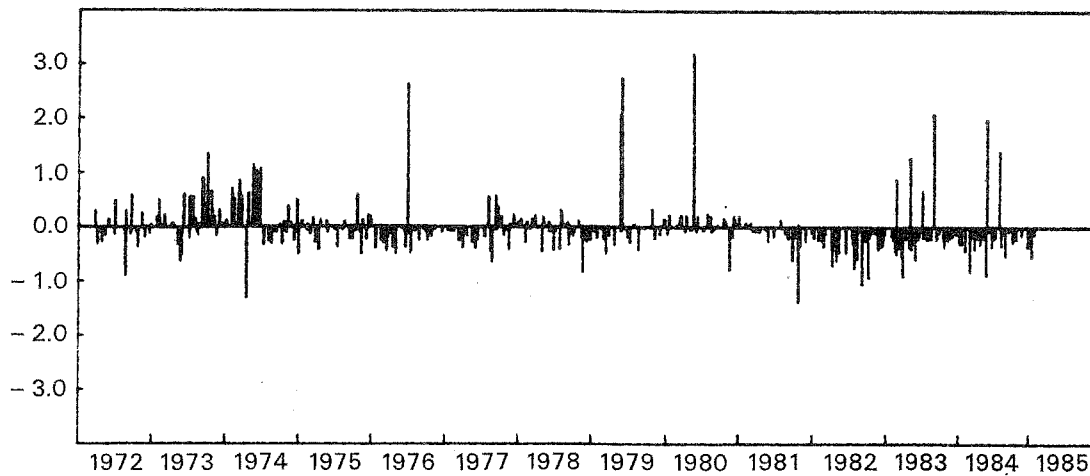

DRY WEIGHTS : OUTTURN MINUS SHIPPED – OXIDATION AND WEIGHING ERRORS

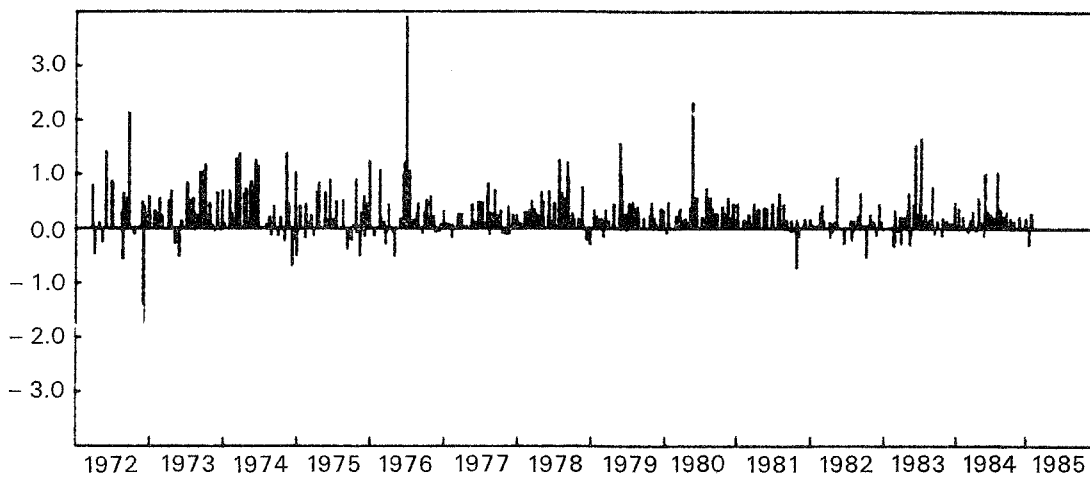

DRY WEIGHTS : APPLICABLE MINUS SHIPPED

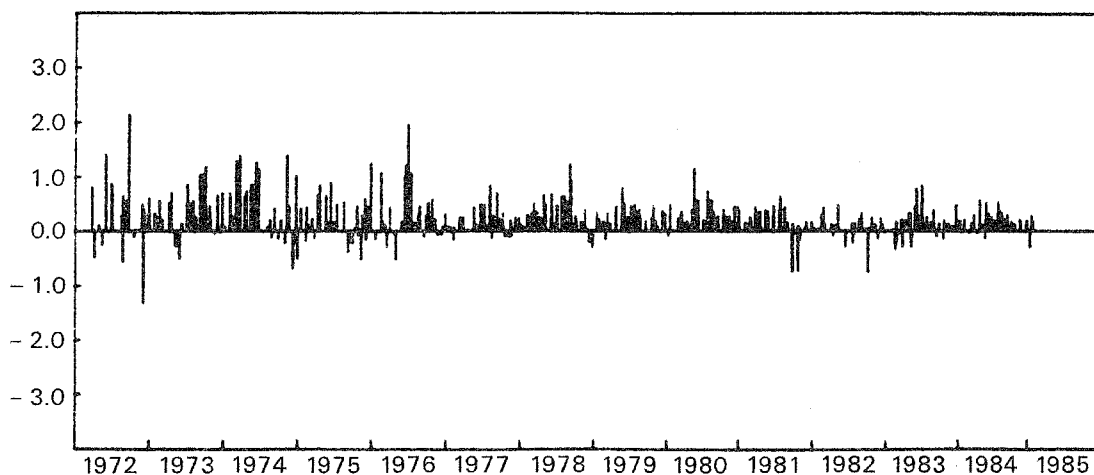
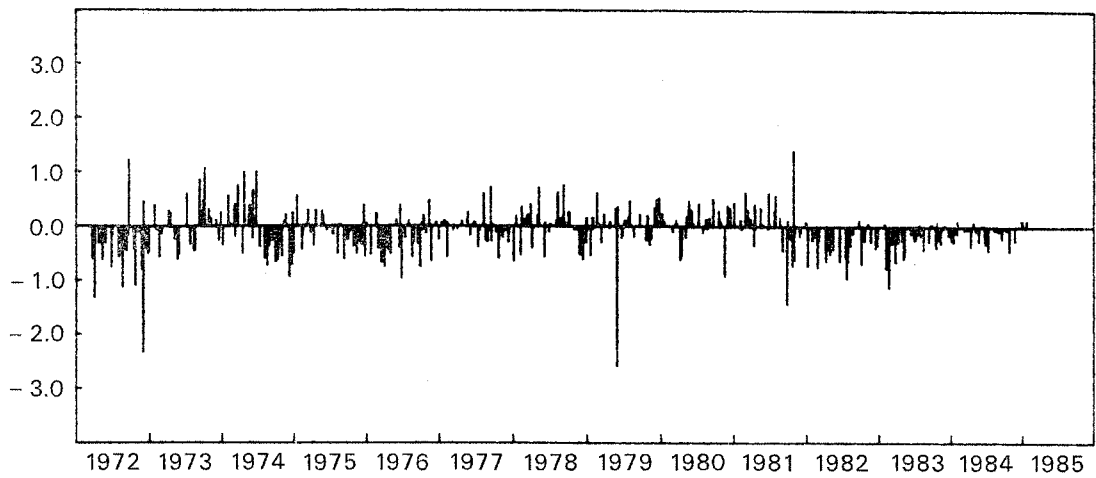

Fig. 2 — Wet and dry weights of shipped concentrate

RELATIVE
DIFFERENCE

%

OUTTURN MINUS SHIPPED : WEIGHING AND SAMPLING ERRORS (SELLER ASSAYS)



BUYER MINUS SELLER : CONTAINED METAL BIAS (OUTTURN SAMPLES AND WEIGHTS)

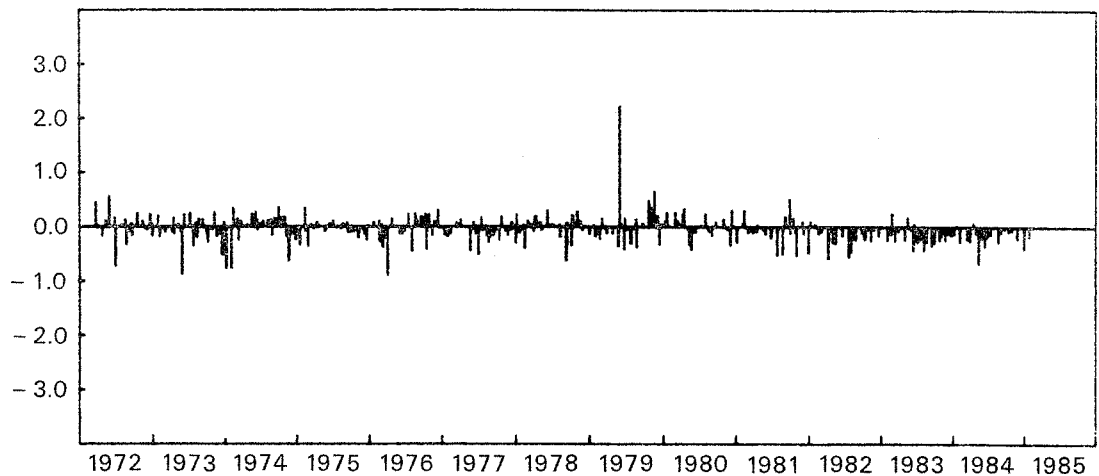

APPLICABLE MINUS SHIPPED - FINANCIAL LOSS/GAIN

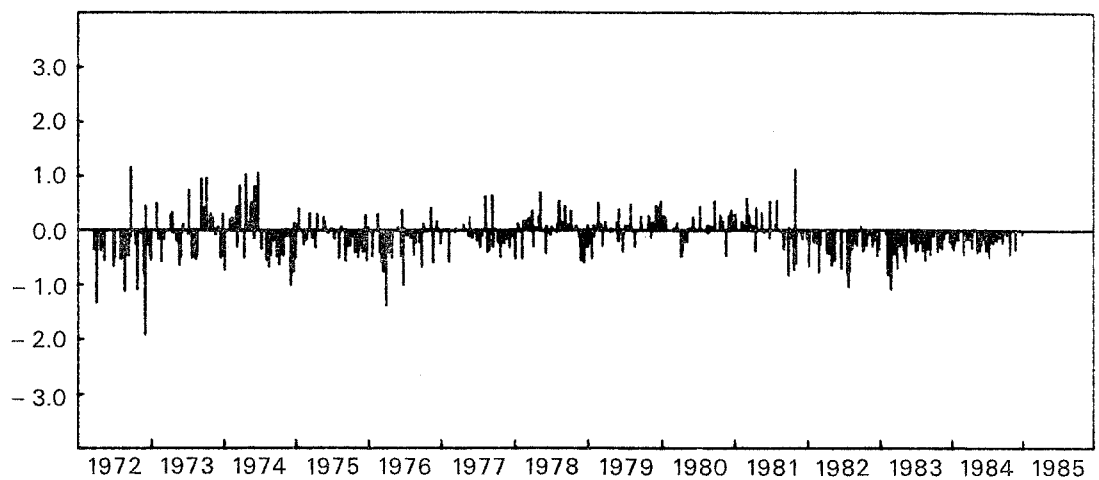

Fig. 3 — Contained copper differences

LITTÉRATURE

Rép. Féd. d'Allemagne

Une brochure sur les instruments de mesure en continu des émissions de pollution de l'air vient d'être publiée en anglais par le Ministère Fédéral de l'Intérieur de la RFA. Cette publication intitulée « Air Pollution Control - Manual of Continuous Monitoring » peut être obtenue auprès du

Bundesministerium des Innern
P.O. Box 170 290
D-5300 Bonn 1

Elle a été élaborée par l'Agence Fédérale de l'Environnement en coopération avec l'Organisation des Agences d'Inspection techniques et l'Association des Fabricants de matériel électrique.

La brochure contient 132 pages. Il existe un résumé séparé en français (ref. ED N° 79, mai 1985) établi par le Centre interprofessionnel technique d'Etudes de la Pollution Atmosphérique, 28, rue de la Source, 75016 Paris.

La brochure décrit, avec de nombreuses illustrations et références bibliographiques, les différents instruments utilisés pour l'enregistrement en continu des émissions de poussières et gaz polluants des usines ainsi que les méthodes d'essai de performance exécuté par les laboratoires agréés en RFA.

Les appendices comprennent des extraits de réglementations légales et prescriptions administratives relatives aux essais d'évaluation, installation et maintenance de ces instruments ainsi qu'un catalogue de modèles évalués et fabriqués par l'industrie allemande.

Rép. Pop. de Chine

Les Recommandations Internationales de l'OIML du N° 1 au N° 57 ont été traduites en chinois. Des copies peuvent être obtenues en écrivant au Membre du CIML de ce pays.

Suisse

Une réglementation vient d'être publiée avec le titre « Ordonnance sur les appareils mesureurs de gaz d'échappement des moteurs à allumage commandé, 15 mai 1985 ».

Cette réglementation contient beaucoup de points intéressants concernant les erreurs maximales tolérées, essais des facteurs d'influence, etc. et couvre les gaz à analyser suivants : CO, CO₂, C₆H₁₄ (moteurs à essence) et C₃H₈ (moteurs à propane).

En plus des prescriptions métrologiques, la réglementation spécifie également certaines exigences techniques. On peut noter par exemple que l'utilisation de correcteurs de pression de type modulaire est admise et que les essais de l'influence des perturbations électromagnétiques sont abordés d'une façon pragmatique.

La Suisse a également édité une directive datée du 2 septembre 1985 pour la vérification de thermomètres électriques utilisés pour la mesure des températures des gaz d'émission des chaudières. La motivation de cette directive est que ces types de thermomètres sont utilisés pour l'évaluation du rendement des installations de chauffage. Les erreurs maximales globales prescrites pour ces thermomètres sont $\pm 3^\circ\text{C}$ de 0 à 100 °C, $\pm 3\%$ de l'indication entre 100 et 200 °C et $\pm 6^\circ\text{C}$ entre 200 et 300 °C.

Yougoslavie

Le Bureau Fédéral des Mesures et Métaux Précieux a édité un grand nombre de publications concernant la métrologie légale. La plupart de ces publications sont écrites en serbo-croate. Cependant, en 1983, il a été publié une version du Vocabulaire de Métrologie Légale (édition 1978) qui contient, en plus des explications des termes en français et en serbo-croate, également les titres de termes en français, anglais, allemand, russe, serbo-croate, croate, slovene, macédonien, albanais et hongrois, formant ainsi un intéressant cocktail linguistique de métrologie, très bien édité et avec un index de termes dans toutes ces langues.

La nouvelle loi sur les unités et les instruments de mesure, publiée dans le journal officiel N° 9, 1984 a été éditée en traduction anglaise avec le titre « Law on Units of Measurements and Measuring Instruments, Belgrade, April 1985 ».

Les approbations de modèle et les instructions métrologiques sont publiées dans une série périodique ayant pour titre GLASNIK (Bulletin).

Un grand nombre de monographies et manuels sur différents sujets a aussi été publié en serbo-croate ; les titres de certaines de ces publications reçues au BIML sont indiqués en traduction anglaise dans la section anglaise « Literature » dans ce Bulletin.

LITERATURE

Fed. Rep. of Germany

A brochure with the title « Air Pollution Control - Manual of Continuous Emission Monitoring » has been published in 1985 by the Federal Ministry of the Interior and can be obtained from

Bundesministerium des Innern
P.O. Box 170 290
D-5300 Bonn 1

This brochure of 132 pages, in English, has been elaborated by the Federal Environmental Agency in Berlin in cooperation with the Organisation of Technical Inspection Agencies and the German Electrical Manufacturers Association.

It describes with numerous illustrations and bibliographic references the various principles of instruments used for continuous monitoring of dust and gas emissions from factories as well as the suitability tests executed by authorized testing institutes in the FRG.

Appendixes include legislative and administrative regulations including guidelines for evaluation testing, installation and maintenance of emission measurement instruments as well as an illustrated catalogue of suitability tested instrument patterns manufactured in FRG.

People's Republic of China

The International Recommendations of OIML from No. 1 through No. 57 have been translated into Chinese. Copies can be obtained by writing to the CIML Member of this country.

Switzerland

A regulation concerning exhaust gas analyzers for automobiles has recently been issued : Ordonnance sur les appareils mesureurs de gaz d'échappement des moteurs à allumage commandé, 15 mai 1985, available in the French, German and Italian languages.

This regulation contains many interesting points as regards accuracy requirements, testing of influence factors, etc. and covers the following analyzed gases : CO, CO₂, C₆H₁₄ (gasoline engines) and C₃H₈ (propane engines). Both metrological and technical requirements are laid down. One may note that atmospheric pressure compensators of modular type are admitted and that pattern approval testing for electromagnetic disturbances follows a pragmatic approach.

Switzerland has also issued a directive for the testing of electrical thermometers used for measuring the temperature of the exhaust gas from heating installations. It is dated 2 September 1985 and is available in French and German. This directive is motivated by the fact that such instruments are used for the evaluation of the performance of heating installations. The global prescribed maximum permissible errors for such thermometers are $\pm 3^\circ\text{C}$ from 0 to 100 $^\circ\text{C}$, $\pm 3\%$ of indication between 100 and 200 $^\circ\text{C}$ and $\pm 6^\circ\text{C}$ between 200 and 300 $^\circ\text{C}$.

Yugoslavia

The Federal Bureau of Measures and Precious Metals has issued a great number of publications related to legal metrology activities. Most of the publications are issued in Serbo-Croat language. However, in 1983, an edition of the 1978 version of the Vocabulary of Legal Metrology has been published which, in addition to the explanations in French and Serbo-Croat, contains the titles of the terms in the following languages : French, English, German, Russian, Serbo-Croat, Croat, Slovenian, Macedonian, Albanian and Hungarian, forming thus an interesting linguistic cocktail of metrology, very well edited along with an index of terms in all the listed languages.

The new « Law on units of measurements and measuring instruments » published in the Official Gazette of the SFRY No. 9, 1984, has been issued in English translation (Belgrade, April 1985).

The pattern approvals and metrological instructions are published in a series of periodicals with the title GLASNIK (Bulletin).

A large number of monographs and manuals on various subjects has also been published in Serbo-Croat language ; some of their titles are listed below in English translation :

- Monograph No. 2 — Evaluation of Measuring Uncertainties, by Marijan Brezinscak
 - Monograph No. 3 — Examination of Indicating Electrical Measuring by Mile Pesaljevic
 - Manual No. 4 — Reduction Tables for Determination of Real Strength of Alcohol Solutions in Volume Percents at Standard Temperature of 15 °C
 - Monograph No. 5 — Verification of Various Accuracy Class Weights, by Dobrivoje Prokic
 - Manual No. 6 — Legal Units of Measurements in SFR of Yugoslavia, by Dobrivoje Prokic
 - Manual No. 7 — Sixteenth General Conference on Weights and Measures, prepared by Milorad Radisavljevic
 - Manual No. 8 — Metrological Requirements for Mechanical and Heat Quantity Measuring Instruments
 - Manual No. 9 — Metrological Requirements for Physical-Chemical Quantity Measuring Instruments
 - Manual No. 10 — Metrological Requirements for Electrical Quantity Measuring Instruments
 - Monograph No. 11 — Induction Type Energy Meters, by Zdravko Hukavec
 - Monograph No. 12 — Electrical Energy Measurements, by Djordje Blagojevic
 - Manual No. 13 — International Practical Temperature Scale of 1968, Amended 1975 edition, translated by Gordana Dankovic and Milorad Radisavljevic
 - Manual No. 15 — Metrological Requirements published in 1982
 - Manual No. 16 — Seventeenth General Conference on Weights and Measures, prepared by Milorad Radisavljevic and a group of metrologists
- Calibration Possibilities of the Federal Bureau of Measures and Precious Metals and its Accreditive Laboratories.
- Administrative Pattern Evaluation Procedure, by Mile Pesaljevic.

REUNIONS

Groupes de travail	Dates	Lieux
SP 6 - Sr 1 Compteurs de gaz à parois déformables	} 26-30 mai 1986	PARIS FRANCE
SP 6 - Sr 2 Compteurs de gaz à pistons rotatifs. Compteurs de gaz non volumétriques		
SP 5s - Sr 8 Réservoirs de stockage	} juin 1986 (provisoire)	—
SP 5s - Sr 9 Camions et wagons citernes		
SP 5s - Sr 10 Péniches et navires citernes		
SP 5s - Sr 11 Dispositifs de repérage des niveaux de liquides dans les réservoirs		
SP 2 - Sr 5 Contrôle par échantillonnage	} fin août 1986 (provisoire)	ST-GALL SUISSE
SP 20 - Sr 1 Contenu informatif de l'étiquetage des produits préemballés		
SP 20 - Sr 2 Vérification des quantités contenues dans les emballages		
SP 17 - Sr 2 Mesure des pollutions de l'eau	} 15-19 sept. 1986 (provisoire)	BIML PARIS
SP 17 - Sr 4 Mesure des pollutions par pesticides et substances toxiques		
SP 7 - Sr 4 Instruments de pesage à fonctionnement non automatique	sept. 1986 (provisoire)	HELSINKI FINLANDE
SP 7 - Sr 5 Instruments de pesage à fonctionnement automatique	sept. 1986 (provisoire)	LONDRES ROYAUME-UNI
<hr style="width: 20%; margin: 10px auto;"/>		
Conseil de Développement	14-15 avril 1986	PARIS FRANCE
21ème Réunion du Comité International de Métrologie Légale	16-18 avril 1986	PARIS FRANCE
<hr style="width: 20%; margin: 10px auto;"/>		

PUBLICATIONS

- Vocabulaire de métrologie légale
Vocabulary of legal metrology
- Vocabulaire international des termes fondamentaux et généraux de métrologie
International vocabulary of basic and general terms in metrology

RECOMMANDATIONS INTERNATIONALES

INTERNATIONAL RECOMMENDATIONS

RI N°

- 1 — Poids cylindriques de 1 g à 10 kg (de la classe de précision moyenne)
Cylindrical weights from 1 g to 10 kg (medium accuracy class)
- 2 — Poids parallélépipédiques de 5 à 50 kg (de la classe de précision moyenne)
Rectangular bar weights from 5 to 50 kg (medium accuracy class)
- 3 — Réglementation métrologique des instruments de pesage à fonctionnement non automatique
Metrological regulations for non automatic weighing instruments
- 4 — Fioles jaugées (à un trait) en verre
Volumetric flasks (one mark) in glass
- 5 — Compteurs de liquides autres que l'eau à chambres mesureuses
Meters for liquids other than water with measuring chambers
- 6 — Prescriptions générales pour les compteurs de volume de gaz
General specifications for volumetric gas meters
- 7 — Thermomètres médicaux (à mercure, en verre, avec dispositif à maximum)
Clinical thermometers (mercury-in-glass, with maximum device)
- 9 — Vérification et étalonnage des blocs de référence de dureté Brinell
Verification and calibration of Brinell hardness standardized blocks
- 10 — Vérification et étalonnage des blocs de référence de dureté Vickers
Verification and calibration of Vickers hardness standardized blocks
- 11 — Vérification et étalonnage des blocs de référence de dureté Rockwell B
Verification and calibration of Rockwell B hardness standardized blocks
- 12 — Vérification et étalonnage des blocs de référence de dureté Rockwell C
Verification and calibration of Rockwell C hardness standardized blocks
- 14 — Saccharimètres polarimétriques
Polarimetric saccharimeters

- 15 — Instruments de mesure de la masse à l'hectolitre des céréales
Instruments for measuring the hectolitre mass of cereals
- 16 — Manomètres des instruments de mesure de la tension artérielle (sphygmo-
manomètres)
Manometers for instruments for measuring blood pressure (sphygmomanometers)
- 17 — Manomètres, vacuomètres, manovacuumètres indicateurs
Indicating pressure gauges, vacuum gauges and pressure-vacuum gauges
- 18 — Pyromètres optiques à filament disparaissant
Optical pyrometers of the disappearing filament type
- 19 — Manomètres, vacuomètres, manovacuumètres enregistreurs
Recording pressure gauges, vacuum gauges, and pressure-vacuum gauges
- 20 — Poids des classes de précision E_1 E_2 F_1 F_2 M_1 de 50 kg à 1 mg
Weights of accuracy classes E_1 E_2 F_1 F_2 M_1 from 50 kg to 1 mg
- 21 — Taximètres
Taximeters
- 22 — Tables alcoométriques internationales
International alcoholometric tables
- 23 — Manomètres pour pneumatiques de véhicules automobiles
Tyre pressure gauges for motor vehicles
- 24 — Mètre étalon rigide pour agents de vérification
Standard one metre bar for verification officers
- 25 — Poids étalons pour agents de vérification
Standard weights for verification officers
- 26 — Seringues médicales
Medical syringes
- 27 — Compteurs de volume de liquides (autres que l'eau). Dispositifs complémentaires
Volume meters for liquids (other than water). Ancillary equipment
- 28 — Réglementation technique des instruments de pesage à fonctionnement non-
automatique
Technical regulations for non-automatic weighing machines
- 29 — Mesures de capacité de service
Capacity serving measures
- 30 — Mesures de longueur à bouts plans (calibres à bouts plans ou cales-étalons)
End standards of length (gauge blocks)
- 31 — Compteurs de volume de gaz à parois déformables
Diaphragm gas meters
- 32 — Compteurs de volume de gaz à pistons rotatifs et compteurs de volume de
gaz à turbine
Rotary piston gas meters and turbine gas meters

- 33 — Valeur conventionnelle du résultat des pesées dans l'air
Conventional value of the result of weighing in air
- 34 — Classes de précision des instruments de mesurage
Accuracy classes of measuring instruments
- 35 — Mesures matérialisées de longueur pour usages généraux
Material measures of length for general use
- 36 — Vérification des pénétrateurs des machines d'essai de dureté
Verification of indenters for hardness testing machines
- 37 — Vérification des machines d'essai de dureté (système Brinell)
Verification of hardness testing machines (Brinell system)
- 38 — Vérification des machines d'essai de dureté (système Vickers)
Verification of hardness testing machines (Vickers system)
- 39 — Vérification des machines d'essai de dureté (systèmes Rockwell B, F, T - C, A, N)
Verification of hardness testing machines (Rockwell systems B, F, T - C, A, N)
- 40 — Pipettes graduées étalons pour agents de vérification
Standard graduated pipettes for verification officers
- 41 — Burettes étalons pour agents de vérification
Standard burettes for verification officers
- 42 — Poinçons de métal pour agents de vérification
Metal stamps for verification officers
- 43 — Fioles étalons graduées en verre pour agents de vérification
Standard graduated glass flasks for verification officers
- 44 — Alcoomètres et aréomètres pour alcool et thermomètres utilisés en alcoométrie
Alcoholometers and alcohol hydrometers and thermometers for use in alcoholometry
- 45 — Tonneaux et futailles
Casks and barrels
- 46 — Compteurs d'énergie électrique active à branchement direct (de la classe 2)
Active electrical energy meters for direct connection (class 2)
- 47 — Poids étalons pour le contrôle des instruments de pesage de portée élevée
Standard weights for testing of high capacity weighing machines
- 48 — Lampes à ruban de tungstène pour l'étalonnage des pyromètres optiques
Tungsten ribbon lamps for calibration of optical pyrometers
- 49 — Compteurs d'eau (destinés au mesurage de l'eau froide)
Water meters (intended for the metering of cold water)
- 50 — Instruments de pesage totalisateurs continus à fonctionnement automatique
Continuous totalising automatic weighing machines
- 51 — Trieuses pondérales de contrôle et trieuses pondérales de classement
Checkweighing and weight grading machines
- 52 — Poids hexagonaux. Classe de précision ordinaire de 100 g à 50 kg
Hexagonal weights. Ordinary accuracy class, from 100 g to 50 kg
- 53 — Caractéristiques métrologiques des éléments récepteurs élastiques utilisés pour le mesurage de la pression. Méthodes de leur détermination
Metrological characteristics of elastic sensing elements used for measurement of pressure. Determination methods

- 54 — Echelle de pH des solutions aqueuses
pH scale for aqueous solutions
- 55 — Compteurs de vitesse, compteurs mécaniques de distances et chronotachygraphes des véhicules automobiles - Réglementation métrologique
Speedometers, mechanical odometers and chronotachographs for motor vehicles. Metrological regulations
- 56 — Solutions-étalons reproduisant la conductivité des électrolytes
Standard solutions reproducing the conductivity of electrolytes
- 57 — Ensembles de mesurage de liquides autres que l'eau équipés de compteurs de volumes. Dispositions générales
Measuring assemblies for liquids other than water fitted with volume meters. General provisions.
- 58 — Sonomètres
Sound level meters
- 59 — Humidimètres pour grains de céréales et graines oléagineuses
Moisture meters for cereal grains and oilseeds
- 60 — Réglementation métrologique des cellules de pesée
Metrological regulations for load cells
- 61 — Doseuses pondérales à fonctionnement automatique
Automatic gravimetric filling machines
- 62 — Caractéristiques de performance des extensomètres métalliques à résistance
Performance characteristics of metallic resistance strain gages
- 63 — Tables de mesure du pétrole
Petroleum measurement tables
- 64 — Exigences générales pour les machines d'essai des matériaux
General requirements for materials testing machines
- 65 — Exigences pour les machines d'essai des matériaux en traction et en compression
Requirements for machines for tension and compression testing of materials
- 66 — Instruments mesureurs de longueurs
Length measuring instruments
- 67 — Ensembles de mesurage de liquides autres que l'eau équipés de compteurs de volumes. Contrôles métrologiques
Measuring assemblies for liquids other than water fitted with volume meters. Metrological controls
- 68 — Méthode d'étalonnage des cellules de conductivité
Calibration method for conductivity cells
- 69 — Viscosimètres à capillaire, en verre, pour la mesure de la viscosité cinématique
Glass capillary viscometers for the measurement of kinematic viscosity.
- 70 — Détermination des erreurs de base et d'hystérésis des analyseurs de gaz
Determination of intrinsic and hysteresis errors of gas analysers
- 71 — Réservoirs de stockage fixes. Prescriptions générales
Fixed storage tanks. General requirements

- 72 — Compteurs d'eau destinés au mesurage de l'eau chaude
Hot water meters
- 73 — Prescriptions pour les gaz purs CO, CO₂, CH₄, H₂, O₂, N₂ et Ar destinés à la préparation des mélanges de gaz de référence
Requirements concerning pure gases CO, CO₂, CH₄, H₂, O₂, N₂ and Ar intended for the preparation of reference gas mixtures

DOCUMENTS INTERNATIONAUX

INTERNATIONAL DOCUMENTS

DI N°

- 1 — Loi de métrologie
Law on metrology
- 2 — Unités de mesure légales
Legal units of measurement
- 3 — Qualification légale des instruments de mesurage
Legal qualification of measuring instruments
- 4 — Conditions d'installation et de stockage des compteurs d'eau froide
Installation and storage conditions for cold water meters
- 5 — Principes pour l'établissement des schémas de hiérarchie des instruments de mesure
Principles for the establishment of hierarchy schemes for measuring instruments
- 6 — Documentation pour les étalons et les dispositifs d'étalonnage
Documentation for measurement standards and calibration devices
- 7 — Evaluation des étalons de débitmétrie et des dispositifs utilisés pour l'essai des compteurs d'eau
The evaluation of flow standards and facilities used for testing water meters
- 8 — Principes concernant le choix, la reconnaissance officielle, l'utilisation et la conservation des étalons
Principles concerning choice, official recognition, use and conservation of measurement standards
- 9 — Principes de la surveillance métrologique
Principles of metrological supervision
- 10 — Conseils pour la détermination des intervalles de réétalonnage des équipements de mesure utilisés dans les laboratoires d'essais
Guidelines for the determination of recalibration intervals of measuring equipment used in testing laboratories

Note — Ces publications peuvent être acquises au / *These publications may be purchased from*
Bureau International de Métrologie Légale, 11, rue Turgot, 75009 PARIS.



ORGANISATION INTERNATIONALE DE MÉTROLOGIE LÉGALE

ETATS MEMBRES

ALGERIE	INDONESIE
REP. FEDERALE D'ALLEMAGNE	IRLANDE
REP. DEMOCRATIQUE ALLEMANDE	ISRAEL
AUSTRALIE	ITALIE
AUTRICHE	JAPON
BELGIQUE	KENYA
BRESIL	LIBAN
BULGARIE	MAROC
CAMEROUN	MONACO
CANADA	NORVEGE
REP. POP. DE CHINE	PAKISTAN
CHYPRE	PAYS-BAS
REP. DE COREE	POLOGNE
REP. POP. DEM. DE COREE	ROUMANIE
CUBA	ROYAUME-UNI DE GRANDE-BRETAGNE ET D'IRLANDE DU NORD
DANEMARK	SRI LANKA
EGYPTE	SUEDE
ESPAGNE	SUISSE
ETATS-UNIS D'AMERIQUE	TANZANIE
ETHIOPIE	TCHECOSLOVAQUIE
FINLANDE	TUNISIE
FRANCE	U.R.S.S.
GRECE	VENEZUELA
GUINEE	YOUgoslavie
HONGRIE	
INDE	

MEMBRES CORRESPONDANTS

Albanie - Bahrein - Botswana - Burkina Faso - Colombie - Equateur - Fidji - Hong Kong - Irak - Islande -
Jamaïque - Jordanie - Koweït - Luxembourg - Mali - Maurice - Népal - Nouvelle-Zélande - Oman - Panama -
Pérou - Philippines - Portugal - Syrie - Trinité et Tobago - Turquie

MEMBRES
du
COMITE INTERNATIONAL de METROLOGIE LEGALE

ALGERIE

Membre à désigner par son Gouvernement
Correspondance adressée à
Direction de l'Administration des Moyens
Sous-Direction de la Métrologie
Ministère des Industries Légères
Rue Ahmed Bey
Immeuble le Colisée
ALGER

REPUBLIQUE FEDERALE D'ALLEMAGNE

Mr W. MUHE
Chef des Bureaux Technico-Scientifiques,
Physikalisch-Technische Bundesanstalt,
Bundesallee 100
3300 BRAUNSCHWEIG.
TP 49-531-5920
TX 9-52 822 PTB
TG Bundesphysik Braunschweig

REPUBLIQUE DEMOCRATIQUE ALLEMANDE

Mr H.W. LIERS
Directeur de la Métrologie Légale,
Amt für Standardisierung, Messwesen,
und Warenprüfung,
Fürstenwalder Damm 388
1162 BERLIN.
TP 37-2-65 260
TX 112630 asmw

AUSTRALIE

Mr T.J. PETRY
Executive Director
National Standards Commission,
P.O. Box 282
NORTH RYDE, N.S.W. 2113.
TP 61-2-888 39 22
TX AA 23144
TG NATSTANCOM Sydney

AUTRICHE

Mr R. LEWISCH
Director of the Metrology Service
Bundesamt für Eich- und Vermessungswesen
Arltgasse 35
A-1163 WIEN.
TP 43-222-92 16 27
TX 115 468 bevwn

BELGIQUE

Madame M.L. HENRION
Inspecteur Général
Service de la Métrologie
24-26, rue J.A. De Mot
B-1040 BRUXELLES
TP 32-2-233 61 11

BRESIL

Mr J. TAVORA VEADO
Président, INMETRO
Praça Mauah N° 7, 13 Andar
20081 RIO DE JANEIRO
TP 021 233 1586 et 233 1184
TX 2134599 IMNQ BR

BULGARIE

Mr P. ZLATAREV
Directeur Général du Centre National
de Métrologie
Comité d'Etat pour la Science et le
Progrès Technique
Département à la Normalisation
21, rue du 6 Septembre
1000 SOFIA
TP — 8591
TX 22 570 DKS
TG techprogress

CAMEROUN

Mr E. NDOUGOU
Chef du Service des Poids et Mesures
Ministère du Commerce et de l'Industrie
Direction des Prix et des Poids et Mesures
YAOUNDE
TP 237-22-35-69
TX 82-68 à Yaoundé

CANADA

Mr R.G. KNAPP
Director, Legal Metrology Branch
Consumer and Corporate Affairs
Tunney's Pasture, Avenue Holland,
Standards Building
OTTAWA, Ontario K1A OC9
TP 1-613-992 38 19
TX 053 3694

REPUBLIQUE POPULAIRE DE CHINE

Mr SONG YONGLIN
Sous-Directeur du Bureau d'Etat de Métrologie
de la R.P.C.
POB. 2112
BEIJING
TP 44.4304
TX 210209 SBM CN

CHYPRE

Mr M. EROTOKRITOS
Chief Industrial Officer
Ministry of Commerce and Industry
NICOSIA.
TP 357-21-40 34 41
TX 2283 MIN COMIND
TG mincommind Nicosia

REPUBLIQUE DE COREE

Mr CHANG KI-JUNG
Director of Metrology Division
Bureau of Standards
Industrial Advancement Administration
2, Chung-and-dong,
KWACH'ON, KYONGGI-DO 171-11
TP 82-2-590-8990
TG KORIIA.

REPUBLIQUE POP. DEM. DE COREE

Mr KIM HI SANG
Directeur de l'Institut Central de Métrologie
du Comité Métrologique auprès du Comité
National de la Science et de la Technologie
Arrondissement de Sadong
PYONGYANG
TG standard

CUBA

Mr J. GOMEZ ROSELL
Director INIMET
c/o Mr Acosta Alemany
Comite Estatal de Normalizacion
Calle 12 N° 314 entre 3A y 5A, Miramar
HABANA
TX 511422 CINAN
TP 53-7-67901
TG CEN HAVANA

DANEMARK

Mr Ove E. PETERSEN
Senior Executive Engineer
Secretariat for Metrology
National Agency of Technology
Tagensvej 135
DK-2200 COPENHAGEN N
TP 45 1 85 10 66
TX 15768 techno DK

EGYPTE

Mr F.A. SOBHY
Président,
Egyptian Organization for Standardization
and Quality Control
2 Latin America Street, Garden City
CAIRO.
TP 20-2-26 355
TX 93 296 EOS
TG TAWHID

ESPAGNE

Mr M. CADARSO
Director,
Centro Espanol de Metrologia
Ministerio de la Presidencia
General Ibanez de Ibero, 3
28071 MADRID
TP 34-1-233 38 00

ETATS-UNIS D'AMERIQUE

Mr D.E. EDGERLY
Manager, Standards Management Program
Office of Product Standards Policy
National Bureau of Standards
Building 101, Room A 625
GAITHERSBURG, Maryland 20899
TP 1-301-921 32 87
TX 898 493 GARG

ETHIOPIE

Mr Yohannes AFEWORK
Head of Technical Service
Ethiopian Standards Institution
P.O. Box 2310
ADDIS ABABA.
TP — 15 04 00 et 15 04 25
TG ETHIOSTAN

FINLANDE

Madame U. LÄHTEENMÄKI
Director of Metrology Department
Technical Inspection Centre
Box 204
SF 00181 HELSINKI 18
TP 358-0-61 671
TG TEKTARTOS HKI

FRANCE

Mr Ph. BERTRAN
Chef du Service de la Métrologie
D.Q.S.I. Ministère du Redéploiement Industriel
et du Commerce Extérieur
30-32, rue Guersant
75840 PARIS Cedex 17
TP 33 (1) 45 72 85 85
TX DIRSIM 649917 F

GRECE

Mr A. DESIS
Technical Officer
Directorate of Weights and Measures
Ministry of Commerce
Canning Sq.
10181 ATHENS
TP 36 14 168
TX 21 67 35 DRAG GR et 21 52 82 YPEM GR

GUINEE

Mr B. CONDE
Directeur du Service National
de Métrologie Légale,
Ministère du Commerce Intérieur
CONAKRY.
TP — 42 403 et 41 720

HONGRIE

Mr D. BELEDI
Président, Országos Mérésügyi Hivatal,
P.O. Box 19
H-1531 BUDAPEST
TP 36-1-85 05 99 et 85 05 40
TX 22-4856 OMH
TG HUNGMETER Budapest

INDE

Mr S. HAQUE
Director, Weights & Measures
Ministry of Food and Civil Supplies
Directorate of Weights and Measures
12-A, Jam Nagar House
NEW DELHI 110 011
TP — 38 53 44
TX 31-3711 COOP IN
TG POORTISAHAKAR

INDONESIE

Mr R. HAROEN
Direktur Metrologi,
Departemen Perdagangan
Jalan Pasteur 27
40171 BANDUNG.
TP 62-22-50 597 et 50 695
TX 28 176 DITMET BD

IRLANDE

Mr P. FANNING
Principal Officer, Legal Metrology Section
Department of Industry, Trade, Commerce and
Tourism
Frederick Building, Setanta Centre,
South Frederick Street,
DUBLIN 2.
TP 353-1-71 08 33
TX 24 651
TG TRADCOM Dublin

ISRAEL

Mr A. RONEN
Controller of Weights, Measures and Standards
Ministry of Industry and Trade
P.O.B. 299
JERUSALEM 91002
TP 972-2-27 241
TG MEMISCOM Jerusalem

ITALIE

Mr C. AMODEO
Capo dell'Ufficio Centrale Metrico,
Via Antonio Bosio, 15
00161 ROMA.
TP 39-6-348 78 34

JAPON

Mr K. IIZUKA
Director General
National Research Laboratory of Metrology
1-4, 1-Chome, Umezono, Sakura-Mura, Niihari-Gun
IBARAKI 305.
TP 81-298-54 41 49
TX 3652570 AIST
TG KEIRYOKEN TSUCHIURA

KENYA

Mr P.A. AYATA
Superintendent of Weights and Measures
Weights and Measures Department
Ministry of Commerce
P.O. Box 41071
NAIROBI
TP 254-2-33 51 55 et 33 51 11
TG ASSIZERS, Nairobi

LIBAN

Membre à désigner par son Gouvernement
Correspondance à adresser à
Service des Poids et Mesures,
Ministère de l'Economie et du Commerce,
Rue Al-Sourati, imm. Assaf
RAS-BEYROUTH.
TP — 34 40 60

MAROC

Mr M. BENKIRANE
Chef de la Division de la Métrologie Légale
Direction du Commerce Intérieur,
Ministère du Commerce et de l'Industrie,
RABAT.
TP 2112-7-51 792

MONACO

Mr A. VATRICAN
Secrétaire Général,
Centre Scientifique de Monaco
16, Boulevard de Suisse
MC MONTE CARLO.
TP 33-93-30 33 71

NORVEGE

Mr K. BIRKELAND
Directeur, Det norske justervesen
Postbox 6832 St. Olavs Plass
0130 OSLO 1
TP 47-2-20 02 26

PAKISTAN

Membre à désigner par son Gouvernement
Correspondance adressée à
Pakistan Standards Institution
39-Garden Road, Saddar
KARACHI-3.
TP — 73 088
TG PEYASAI

PAYS-BAS

Mr J. NIEUWLAND
Chef
Section des Affaires Légales
Dienst van het IJkwezen
Hoofddirectie
Postbus 654
2600 AR DELFT.
TP 31-15-56 92 71
TX 38 373 IJKWZ

POLOGNE

Mr T. PODGORSKI
Président Adjoint,
Polski Komitet Normalizacji, Miar i Jakosci
ul. Elekoralna 2
00-139 WARSZAWA.
TP 48-22-20 54 34
TX 813 642 PKN
TG PEKANIM

ROUMANIE

Mr I. ISCRULESCU
Directeur, Institutul National de Metrologie,
Sos Vitan-Birzesti nr. 11
BUCAREST 4.
TP — 83 35 20
TX 11 871

ROYAUME-UNI

Mr P.B. CLAPHAM
 Director,
 National Weights and Measures Laboratory,
 Department of Trade and Industry
 26, Chapter Street
 LONDON SW1P 4NS.
 TP 44-1-211 30 00
 TX 88 11 074 DTHQ

SRI LANKA

Mr H.L.R.W. MADANAYAKE
 Deputy Commissioner of Internal Trade
 Measurement Standards and Services Division
 Department of Internal Trade
 101, Park Road
 COLOMBO 5.
 TP — 83 261

SUEDE

Mr R. OHLON
 Ingénieur en Chef, Statens Provningsanstalt.
 P.O. BOX 857
 S-501 15 BORÅS.
 TP 46-33-16 50 00
 TX 362.52
 TG TESTING B BORAS

SUISSE

Mr P. KOCH
 Vice-Directeur, Office Fédéral de Métrologie,
 Lindenweg 50
 3084 WABERN/BE.
 TP 41-31-54 10 61
 TX 33 385 LATOP
 TG OFMET

TANZANIE

Mr A.H.M. TUKAI
 Ag. Commissioner for Weights and Measures
 Weights and Measures Bureau
 P.O. Box 313
 DAR ES SALAAM
 TP — 63 639
 TG WEIGHING Dar es Salaam

TCHECOSLOVAQUIE

Mr T. HILL
 Président, Úrad pro normalizaci a mereni,
 Václavské náměstí c.19
 113 47 PRAHA 1 — NOVE MESTO.
 TP 42-2-26 22 51
 TX 121 948 UNM
 TG normalizace

TUNISIE

Mr Ali BEN GAID
 Président Directeur Général
 Institut National de la Normalisation
 et de la Propriété Industrielle
 Boîte Postale 23
 1012 TUNIS BELVEDERE
 TP 216-1-785 922
 TX 13 602 INORPI

U.R.S.S.

Mr L.K. ISSAEV
 Chef du Département de Métrologie,
 Gosstandart,
 Leninsky Prospect 9
 117049 MOSCOU.
 TP — 236 40 44
 TX 411 378 GOST
 TG Moskva-Standart

VENEZUELA

Mr H. REYES CABRERA
 Directeur
 Servicio Nacional de Metrologia
 Ministerio de Fomento,
 Av. Javier Ustariz, Edif. Parque Residencial
 Urb. San Bernardino
 CARACAS.
 TP 58-2-52 14 09
 TX 22 753 MINFO
 TG METROLOGIA Caracas

YUGOSLAVIE

Mr N. BEVK
 Sous-Directeur,
 Bureau Fédéral des Mesures et Métaux Précieux
 Mike Alasa 14
 11000 BEOGRAD.
 TP 38-11-18 37 36
 TX 11 020 YUZMBG

TP = telephone

Les numéros sont en général indiqués pour le régime automatique international à l'exception des numéros qui sont précédés d'un trait.

The call numbers are generally indicated for international automatic dialling except where the local number is preceded by a dash.

TG = telegramme TX = telex

Pour tout télex ou télégramme, il est nécessaire d'indiquer le nom de la personne et sa qualité.
For all telex or telegrams it is necessary to indicate name of person and occupation.

PRESIDENCE

Président K. BIRKELAND, Norvège
1er Vice-Président ... L.K. ISSAEV, U.R.S.S.
2e Vice-Président ... W. MÜHE, Rép. Féd. d'Allemagne

CONSEIL DE LA PRESIDENCE

K. BIRKELAND, Norvège, Président
L.K. ISSAEV, U.R.S.S., V/Président
H.W. LIERS, Rép. Dém. Allemande
Ph. BERTRAN, France
Madame M.L. HENRION, Belgique
Le Directeur du Bureau International de Métrologie Légale

W. MÜHE, Rép. Féd. d'Allemagne, V/Président
D.E. EDGERLY, Etats-Unis d'Amérique
P.B. CLAPHAM, Royaume-Uni

BUREAU INTERNATIONAL DE METROLOGIE LEGALE

Directeur B. ATHANÉ
Adjoint au Directeur S.A. THULIN
Adjoint au Directeur F. PETIK
Ingénieur Consultant A.B. TURSKI
Administrateur Ph. LECLERCO

MEMBRES D'HONNEUR

J. STULLA-GOTZ, Autriche — Président du Comité
H. KONIG, Suisse — Vice-Président du Comité
H. MOSER, Rép. Féd. d'Allemagne — Membre du Conseil de la Présidence
M.D.V. COSTAMAGNA — Premier Directeur du Bureau
V. ERMAKOV, U.R.S.S. — Vice-Président du Comité
A.J. van MALE, Pays-Bas — Président du Comité
A. PERLSTAIN, Suisse — Membre du Conseil de la Présidence

ADRESSES DES SERVICES DES MEMBRES CORRESPONDANTS

ALBANIE

Drejtoria e Kontrollit te Mjeteve Matese
prane Keshillit te Ministrave
TIRANA

BAHREIN

The Responsible of Metrology
Standards and Metrology Section
Ministry of Commerce and Agriculture
P.O. Box 5479
MANAMA

BOTSWANA

The Permanent Secretary
Division of Weights and Measures
Ministry of Commerce and Industry
Private Bag 48
GABORONE

BURKINA FASO

Direction Générale des Prix
Ministère du Commerce
et de l'Approvisionnement du Peuple
B.P. 19
OUAGADOUGOU

COLOMBIE

Superintendencia de Industria y Comercio
Centro de Control de Calidad y Metrologia
Cra. 37 No 52-95, 4° piso
BOGOTA D.E.

EQUATEUR

The Director General
Instituto Ecuatoriano de Normalizacion
Calle Baquerizo Moreno No 454
entre 6 de Diciembre y Almagro
Casilla No 3999
QUITO

FIDJI

The Chief Inspector of Weights and Measures
C/o Ministry of Economic Planning
and Development
P.O. Box 2118
SUVA

HONG-KONG

Commissioner of Customs and Excise
(Attn. : Trading Standards Investigation Bureau)
Customs and Excise Department
HONG-KONG

IRAK

Planning Board
Central Organization for Standardization
and Quality Control
P.O.B. 13032
Al Jadiria
BAGHDAD

ISLANDE

The Director
Icelandic Office of Metrology
Löggildingarstofan
Sioumuli 13
105 REYKJAVIK

JAMAIQUE

The Director
Jamaican Bureau of Standards
6 Winchester Road
KINGSTON 10

JORDANIE

Directorate of Standards
Ministry of Industry and Trade
P.O. Box 2019
AMMAN

KOWEIT

The Under Secretary
Ministry of Commerce and Industry
Department of Standards and Metrology
Post Box No 2944
KUWAIT

LUXEMBOURG

Le Préposé du Service de Métrologie
Administration des Contributions
Rue des Scillas
2529 HOWALD

MALI

Le Directeur Général des Affaires Economiques
(Service des Poids et Mesures)
B.P. 201
BAMAKO

MAURICE

The Director
Mauritius Standards Bureau
Ministry of Commerce and Industry
REDUIT

NEPAL

The Chief Inspector
Mint, Weights and Measures Department
Ministry of Finance
His Majesty's Government
Bhimsenstambha
KATHMANDU

NOUVELLE-ZELANDE

The Chief Inspector of Weights and Measures
Department of Labour
Head Office
Private Bag
WELLINGTON 1

OMAN

The Director General
for Specifications and Measurements
Ministry of Commerce and Industry
P.O. Box 550
MUSCAT

PANAMA

Le Directeur
Comision Panamena de Normas Industriales
y Tecnicas
Ministerio de Comercio e Industrias
Apartado 9658
PANAMA 4

PEROU

The Director General
ITINTEC Instituto de Investigacion Tecnologica
Industrial y de Normas Tecnicas
Apartado 145
LIMA 100

PHILIPPINES

The Director
Product Standards Agency
Ministry of Trade and Industry
Trade & Industry Building
361 Sen. Gil J. Puyat Avenue
Makati, Metro Manila
PHILIPPINES 3117

PORTUGAL

Director-Geral da Qualidade
Ministerio da Industria e Energia
Rue José Estevão, 83-A
1199 LISBOA Codex

SYRIE

The General Director
The Syrian Arab Organization
for Standardization and Metrology
P.O. Box 11836
DAMASCUS

TRINITE ET TOBAGO

The Director
Trinidad and Tobago Bureau of Standards
P.O. Box 467
PORT OF SPAIN

TURQUIE

Le Directeur du Service des Poids et Mesures
Ticaret Bakanligi, Ölçüler ve Ayarlar
Müdür Vekili - Bakanliklar
ANKARA

