

Bulletin OIML n° 89  
Décembre 1982

# BULLETIN

DE

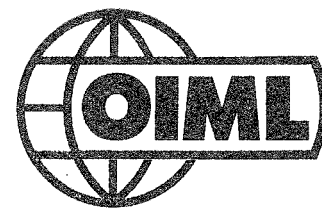

L'ORGANISATION

*Meilleurs vœux*

INTERNATIONALE

DE MÉTROLOGIE LÉGALE

Organe de Liaison entre les Etats-membres

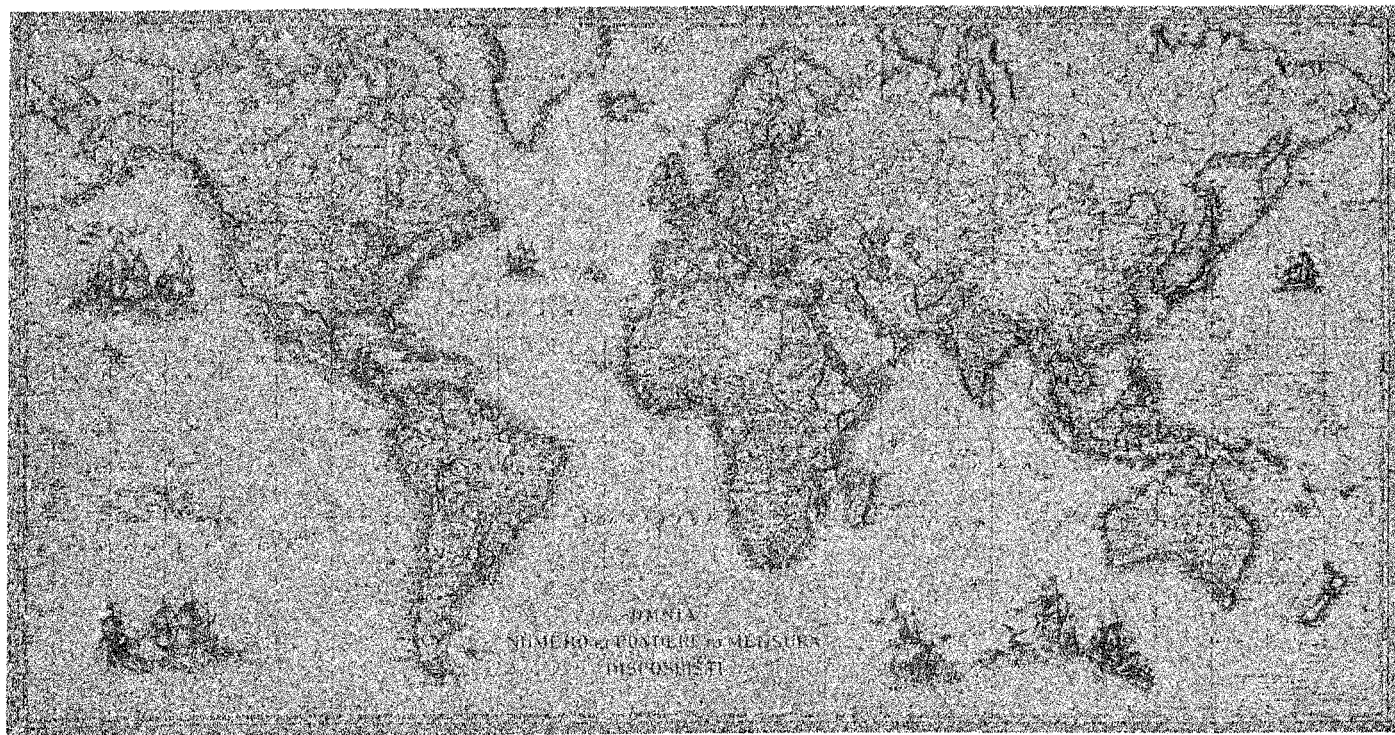

BUREAU INTERNATIONAL DE METROLOGIE LEGALE  
11, Rue Turgot — 75009 PARIS — France



**BULLETIN**  
de  
**L'ORGANISATION INTERNATIONALE de MÉTROLOGIE LÉGALE**

**SOMMAIRE**

	Pages
REPUBLIQUE FEDERALE D'ALLEMAGNE — Experience gained in the inspection of prepackages par W. GÖGGE .....	3
DANEMARK — Legal metrology in Denmark 1683-1982 par H. BLICHFELDT, L. ROSENKILDE et B.F. SORENSEN .....	13
ROUMANIE — Deadweight standard machines for static torque moment reproduction par V. LAMBERT et N. FINTINARU .....	22
ENSEIGNEMENT DE LA METROLOGIE — Littérature .....	35
METROLOGY EDUCATION — Literature .....	36
<b>INFORMATIONS</b>	
Seminar on precision measuring instruments in engineering industries — ECE (United Nations) .....	37
Metrology research organised by the Commission of the European Community .....	40
Réunions .....	42
<b>DOCUMENTATION</b>	
Centre de Documentation : Documents reçus au cours du 4 <sup>e</sup> trimestre 1982 .....	43
Recommandations Internationales : Liste complète à jour .....	47
Etats membres de l'Organisation Internationale de Métrologie Légale .....	50
Membres actuels du Comité International de Métrologie Légale .....	51

Abonnement annuel : Europe : 85 F-français  
Autres pays : 100 F-français  
Chèques postaux : Paris-8 046-24 X  
Banque de France B.P. 140-01 - 75049 Paris Cedex 01  
Comptes Courants, Banques Etrangères : n° 5051-7

BUREAU INTERNATIONAL DE METROLOGIE LEGALE  
11, Rue Turgot — 75009 Paris — France  
Tél. 878-12-82 et 285-27-11 Le Directeur : Mr B. ATHANÉ  
TELEX : 660870 SVP SERV.-code 1103



**EXPERIENCE GAINED**  
**in the INSPECTION of PREPACKAGES**

by **W. GÖGGE**

Director, Legal Metrology Administration, Rheinland-Pfalz

*RESUME — L'article ci-dessous, concernant l'expérience acquise dans la vérification des produits préemballés, donne d'abord un aperçu de la réglementation en vigueur en R.F.A. et décrit ensuite l'équipement de vérification utilisé par l'administration de métrologie légale de Rheinland-Pfalz.*

## **1. Introduction**

For more than ten years the verification authorities of the Federal Republic of Germany and the Land of Berlin have inspected certain prepacked goods destined for the consumer, so-called prepackages. The present paper briefly explains the legal regulations in force and then describes the technical equipment which the verification authority of the Rhineland-Palatinate - a medium-sized authority - has at its disposal to accomplish its task. The description also includes the auxiliary means used, such as the electronic acquisition and processing of data and measurement values and the evaluation of the tests results by means of a computer.

## **2. Metrological requirements for prepackages**

The reason why, at the beginning of the seventies, new regulations were laid down, was the ever-increasing number of prepackages, that is to say, packages containing goods which the consumer is offered in all fields of trade and which are packaged prior to purchase and not in the presence of the buyer, as was formerly the case. The machines used for packaging became more and more elaborate and expensive; they could no longer be verified in the conventional way as they had to be provided with a great variety of correcting devices which required to be adjusted and re-set, even during operation.

It was therefore decided to discontinue the verification of the filling machines; instead, the goods which are produced by these machines must now be tested for compliance with the requirements concerning their contents quantity. Due to the large number of packages, the verification authorities can accomplish this only by random sampling. Procedures had therefore to be developed which, with as little effort and outlay as possible, provide information as accurate as possible on the contents quantity of a large number of packages of the same kind. As regards the contents quantity of the packages, the following requirements were stipulated:

1. The arithmetic mean of the contents quantity of a large number of packages must at least conform with the nominal contents quantity indicated on the packages.
2. Two tolerance limits are fixed: Tu1 and Tu2.
  - 2.1 Only 2 % of the packages may fall below Tu1.
  - 2.2 Packages falling below Tu2 must not be marketed at all.

The definition of the test procedure was first based on the assumption, usually correct, that the statistical distribution of the contents quantities corresponds to a Gaussian distribution as shown in Fig. 1. In this figure curve 1 shows packaging which « optimally » complies with the requirements mentioned above. Curve 2 shows a filling shifted to the right into the safe area. The actual contents quantities are above the nominal contents quantity. In the case of a filling according to curve 1, very small variations, often unavoidable, can result in inadequate fillings which are not admissible.

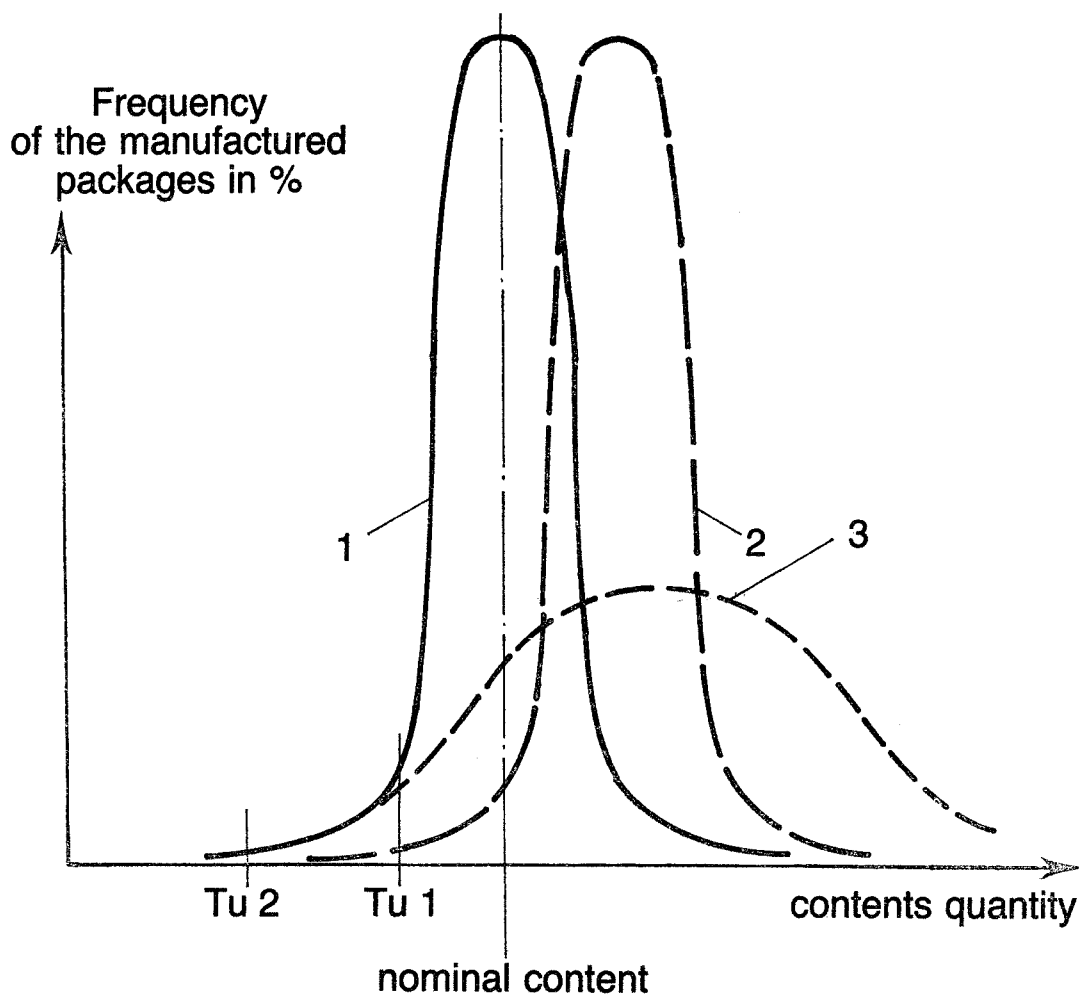

Figure 1  
Possible statistical distribution of the contents quantities

The filling according to curve 3 presents a much wider dispersion than that of curve 1 or 2. Here the contents quantities do not necessarily fall below the permissible tolerances  $Tu_1$  and  $Tu_2$ , but the packages are considerably overfilled. In this case, the packaging firm will have to decide whether in the long run, it is economically feasible to give away so much of the product or whether it is advisable in the future to use better filling systems operating within narrower dispersion limits.

### 3. Duties of the verification authority

The verification authorities must check whether the metrological requirements on the filling procedure specified in the above section are complied with. In doing so, they will organize their inspections in such a way that interference with the economic process is as slight as possible, that the test costs are kept low and that, if possible, the goods to be tested remain undamaged during the inspections. These conditions cannot always be met; an attempt can be made to optimize them by carrying out the inspections in the packaging firm. If, for instance, liquid products are bottled by volume, in order to determine the tare, empty bottles selected at random are weighed, marked, put into the bottling machine and weighed again after filling. The density is determined by means of a pycnometer, a displacement sphere or a DMA-densimeter. This is a densimeter where the oscillation of a glass-tube is a measure for the density. The filled volume is calculated from the density and the net weight. With this kind of inspection, the course of operation need scarcely be interrupted and no goods are destroyed (with the exception of the small amount required for the density determination).

However, if the verification officer wishes to be sure of the accuracy of the filling procedure during periods between own tests packages must be taken from stock. This is also necessary, for example, when at the time the officer is present, filling is impossible for operational reasons, or when the filling system can be so easily adjusted that upon arrival of the verification officer, the machine can be quickly set to a more favourable value. Imported goods filled must be controlled in the same way. As a rule, testing is then destructive as in most cases, the tare is unknown or not sufficiently constant.

At the beginning of every inspection the lot size must first be specified. By this is meant all pieces with the same contents quantity and the same type of packing, which have been filled in the same place during a certain time. For practical reasons, it has been stipulated that all pieces produced within one hour belong to one lot. This criterion, however, cannot always be used; other periods of time can be chosen and other conditions laid down, for example, that the pieces in one batch belong to one lot. When making checks from stock it is necessary to follow this procedure, since as a rule it is not known which piece was produced during any one hour. In general, the rule applies that a lot should contain not more than 10 000 pieces.

From this lot, the sample has to be taken at random. The size of the sample must have been previously specified on the basis of the laws of statistics.

In a non-destructive test, for example, in a lot size consisting of 501 - 3 200 pieces, 80 pieces should be inspected. In a destructive test, this number will have to be considerably reduced in order to keep the quantity of goods destroyed by the test as low as possible. With a lot of the same size (501 to 3 200 pieces) 13 pieces are sufficient to make an estimation of the filling. On one point, however, we must be quite clear: after inspecting 13 pieces, it is impossible to make such confident statements on the quality of the filling as after inspecting 80 pieces. In every case, it is important for the samples to be selected at random. It is not admissible, for example, to check only those pieces which are on the top of a pallet. Each piece must have the same chances of being selected for inspection, and for this reason it is quite possible that further handling by cranes and fork-lifts will be necessary. After this, the mean value of the sample is determined and checked to ascertain whether the permissible tolerances have been met. The equipment described in section 4 is used for this purpose.

Besides metrological work of this kind, the verification officer is also entrusted with other tasks. He must check that the piece is labelled according to regulations, that the contents quantity as printed is of the prescribed size and is clearly legible, that particulars of the manufacturer are given (name of maker, place of registered office and manufacture) or if it is a so-called deceptive package, that is, a package

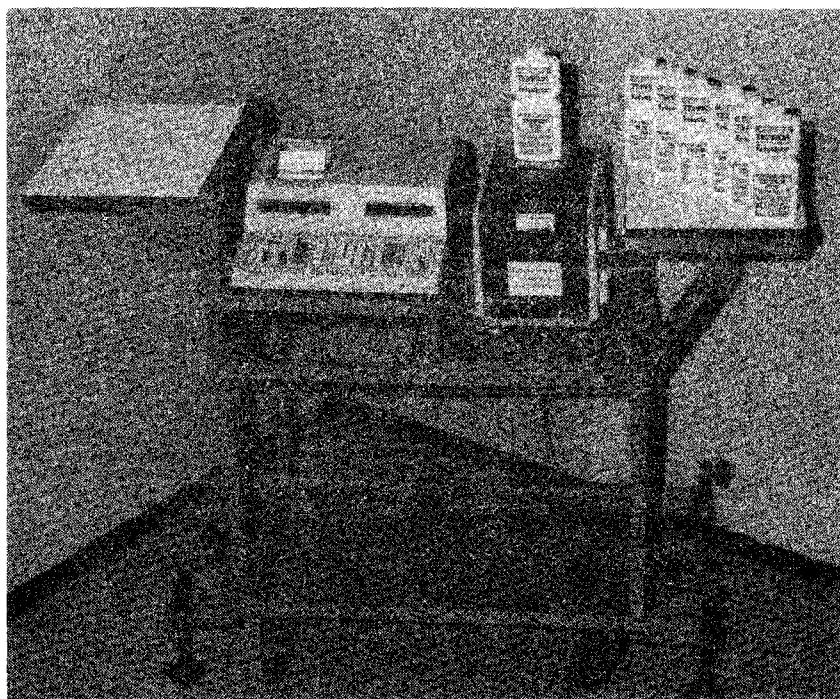

Figure 2

Testing device first used for prepackages. The weight values are fed into the computer by hand

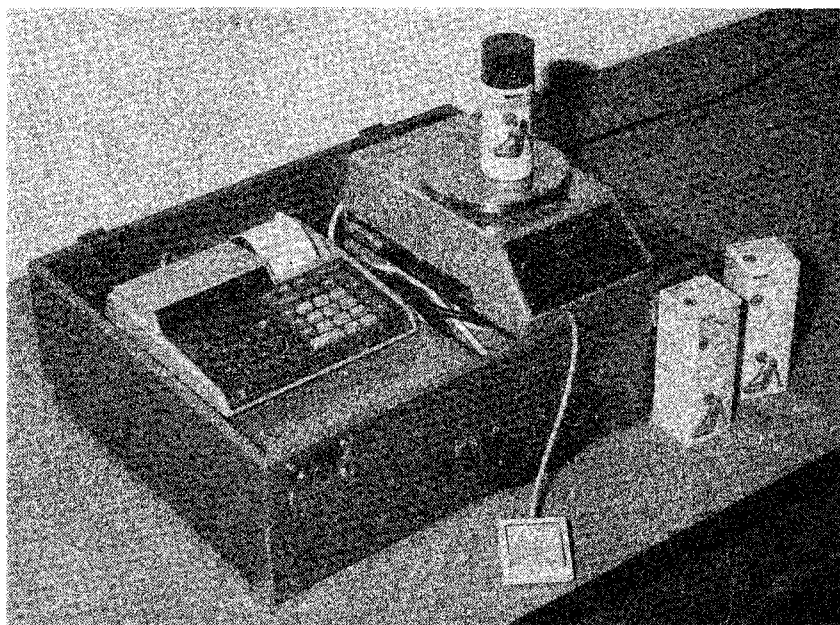

Figure 3

Compact testing device

Electronic high-accuracy weighing instrument, maximum capacity 3 kg with two weighing ranges :  
up to 800 g, 10 mg interval - up to 3 000 g, 0.1 g interval  
Tare range up to 3 000 g. Direct connection to computer



where the volume of the quantity filled is out of all tolerable proportion to the total volume of the container.

As the manufacturer does not have to use verified filling machines, provisions should be made so that he uses verified measuring equipment for the adjustment of the packaging machines and for his own checks on the packages produced. It is then the task of the verification officer to see that this equipment has been verified, and if necessary to carry out a subsequent verification.

If there exists an obligation for the manufacturer to record and statistically evaluate the values obtained from his own checks, the verification officer will also inspect these records. If in doing so, he discovers that the records show inadmissible values, it is not a punishable offense according to our interpretation of the law, since an offender is not obliged to produce evidence of his own guilt. In such a case, the verification officer will visit the firm at short intervals to ascertain that the packaged goods are in order. Inspections at shorter intervals are also recommended after rejection of a lot during the regular inspections.

In our experience, the inspection of prepackages at the point of sale is of great importance. Here, however, in general it is not packages of the same nominal contents quantity which are inspected, but packages of varying nominal contents quantity (for example: packaged meat, cheese, fruit, vegetables). In this case statistical methods for checking the contents quantity cannot be applied. The deviation from the content quantity printed on the label of every individual package shall not be greater than the maximum permissible error laid down in the Regulations. During inspections of prepackages of varying contents quantity we have found that 20 % to 30 % of the packages tested were incorrectly filled.

## **Inspections**

In every case, at least one measuring instrument for examining the contents quantity is required. As a rule, weighing instruments are used, even when the volume of packages is to be tested. In this case, the density must also be determined, but by doing this instead of only using a volume-measuring instrument more reliable data can be obtained.

There are however, products which can only be tested with a volume-measuring instrument, when for example it is not possible to determine correctly the density; this is the case with canned fruit and paints.

For the statistical evaluation the verification officer should in addition to the weighing instrument have at least a pocket-calculator, at his disposal; with a statistics-calculator, the evaluation of the test will be that much easier.

The calculator should preferably be equipped with a printer as this provides evidence while avoiding errors which could arise through writing by hand.

A testing device of this kind, as used by the verification authorities in the Rhineland-Palatinate shortly after the introduction of the regulations governing pre-packages, is shown in Fig. 2.

The indicated values must be read off by the inspector and put manually into the computer standing beside the device. The trolley enables the equipment to be transported within the packer's premises and also provides a space for depositing the packages to be inspected.

Reading of the indications was not necessary in a later version of the equipment (introduced in 1972) where the mechanical weighing instrument was fitted with an electronic read-out device and an interface for a desk-computer.

However, both these devices were in use for a few years only; they proved to be too bulky and difficult to transport. A device like the one shown in Fig. 3 is now used. The precision weighing instrument is electronic and has a maximum

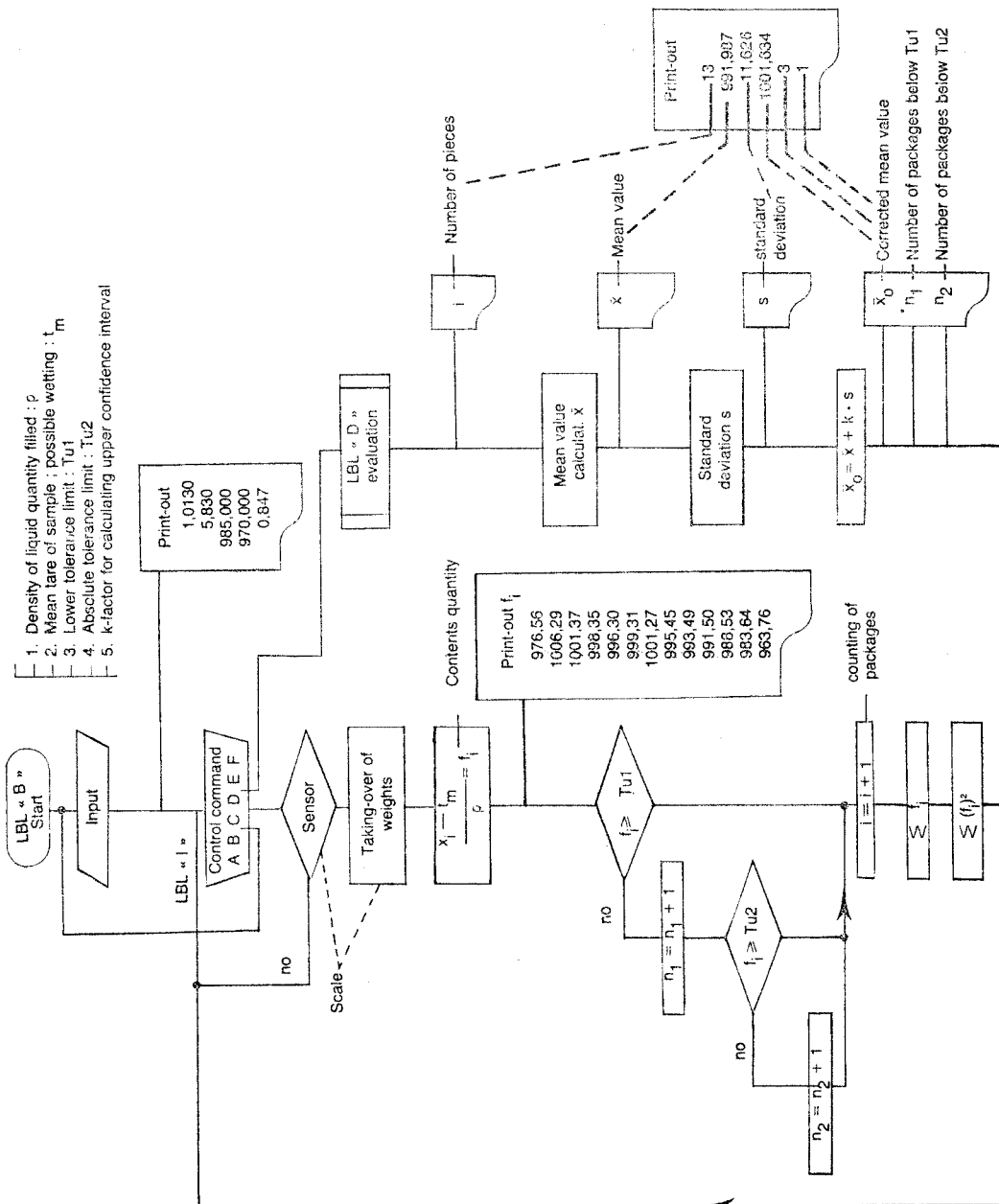

Figure 4  
 Signal flow chart of a computer-aided prepacage test with an HP 97 S computer  
 (Example : Statistical testing of packages with liquid contents ; sample size : 13 pieces)

capacity of 3 kg. It covers two weighing ranges, the first extends to 800 g with 1 interval  $\cong$  10 mg and the second to 3 000 g with 1 interval  $\cong$  0,1 g. The changeover is automatic. The tare range extends to 3 000 g. Besides countless pre-wired mathematical, statistical and scientific functions, the connected computer is freely programmable by means of magnetic cards. The signal flow chart for a practical prepackage inspection is shown in Fig. 4. The computer has 26 data memory registers, 224 storable program steps and 3 subroutine levels. The precision weighing instrument and the computer Hewlett Packard 97S together with both interfaces and the power supply are installed in a suitcase. The equipment is thus very compact. Its dimensions are 500 mm  $\times$  380 mm  $\times$  150 mm, the weights are: weighing instrument 6.2 kg, interface of the weighing instrument 1.2 kg, computer together with its interface 1.7 kg and the suitcase with power supply 6.6 kg. The total weight of the whole equipment is 15.7 kg. As the equipment is not operated by batteries, it is necessary to connect it to a 220 V power supply system.

The weighing instrument is a Sartorius 1264 MP, but one may as well use a Mettler Delta Range PC 4400. There is only few elastic material in the suitcase to protect the equipment from shocks and vibration. During almost 2 years since this equipment is in use, we had however no problems with these influences. Despite the large number of facilities the computer's storage capacity is too limited to deal with every possible kind of prepackage inspection. The necessary calculations can indeed be made, but the programming, the input and processing of data are more convenient with the newly-developed computers which will replace those now in use.

One particular advantage of the device used at present is its compactness.

#### 4. Evaluation of tests

The verification officer receives directly at the place of inspection an audit from the computer showing whether the prescribed requirements have been met. He can discuss this immediately with the person responsible at the packing plant, and initiate corrective action. In the case of faults being found, he must also decide what punitive measures are necessary. These range from a verbal caution or an on-the-spot cautionary fine of up to 20 DM, to being reported for contravention of the regulations, which in turn is punishable by a court fine of up to 10 000 DM.

In the Rhineland-Palatinate, the reports of contravention of the regulations are not dealt with by the individual verification offices, but by the verification authority responsible for the whole Land. It has proved to be of vital necessity that any reports of contravention of regulations are thoroughly investigated.

A court fine should only be imposed when it has been proved that the accused has acutally contravened existing regulations. The audit must thus be checked and a report drawn up using such wording that it can be submitted as possible evidence to an ordinary court of law. The equipment shown in Fig. 5 serves this purpose. The operator of the device is able to conduct a direct dialogue via the screen so that after completion of the program, all necessary details are included in the audit. The legislation governing the control of prepackages is contained in the computer program. A flow chart is shown in Fig. 6. When the test has been completed, an audit such as the one shown in Table 1 is printed. This is the basis of a penalty notice issued by an automatic typewriter (screen device with two disk storage units and a high-speed wheel printer). We do not use a printed form for a penalty notice - as is frequently the case - but write a personal letter, giving the offender a detailed explanation of the shortcomings discovered during the prepackage inspection.

The computer program is written by the Rhineland-Palatinate verification authority itself, making it possible for all changes in regulations to be immediately included. Programs are available on request.

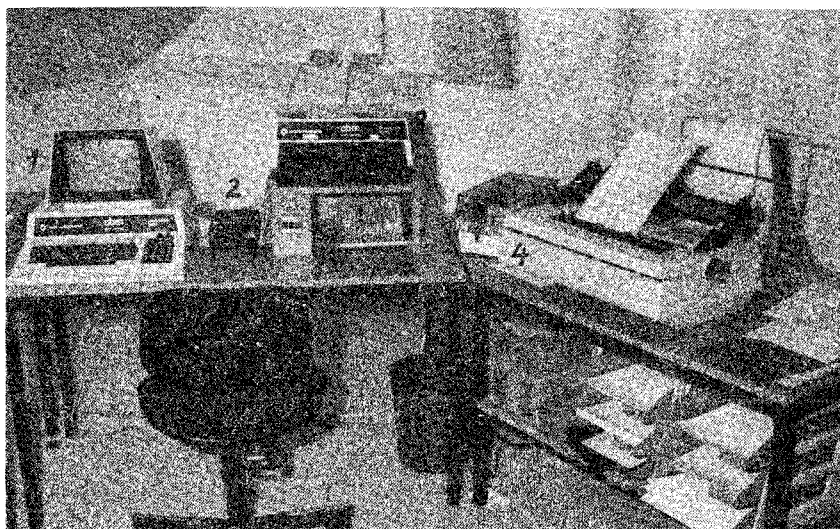

Figure 5

Equipment for the evaluation of prepackage tests

1. Personal computer 2. Tape recorder for the input of a « Start » routine (auxiliary program to facilitate operation) 3. Double-floppy disc memory 4. Wheel-printer, 25 characters/s for single sheet or continuous roll.

Thanks to these rationalized testing and evaluation methods it was possible to carry out 3 940 inspections at producers in the Rhineland-Palatinate in 1981 and to test 190 000 prepackages in 5 599 random sample tests. In 11.3 % of all cases, the mean value was too low, in 4.9 % the tolerance limit Tu1, and in 8.9 % the tolerance limit Tu2 were not complied with.

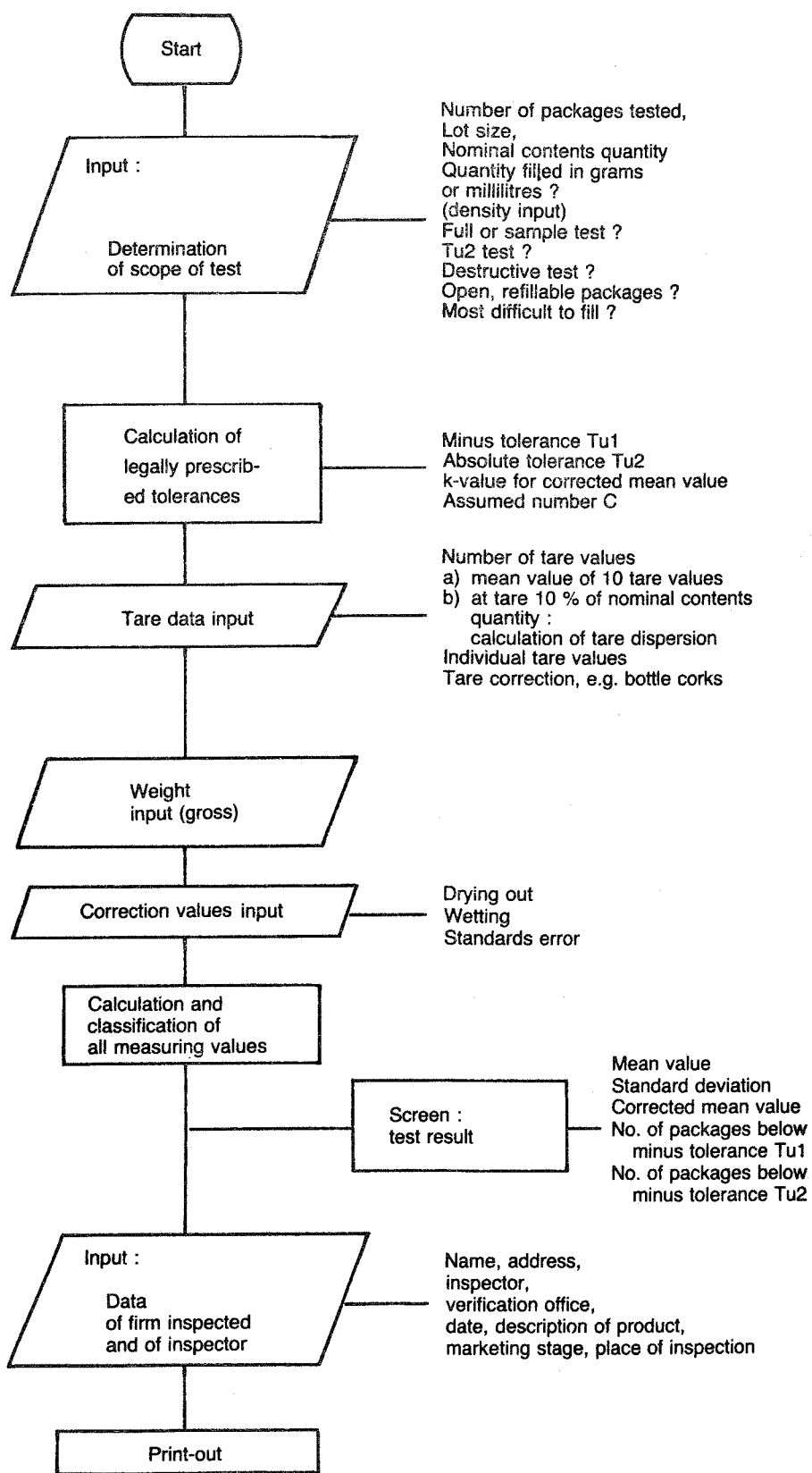

Figure 6

Computer-aided scheme of the operating sequence of a prepackage test with a CBM 3032 computer

Table 1

**EVALUATION FOR THE RECORD OF A PREPACKAGE  
VERIFICATION OF THE SAME NOMINAL PACKAGE CONTENT  
(translation)**

Date of test :	30.2.1982
Verification administration	Bad Kreuznach
Verification officer	Muller
Tests made at	Imported Co. Fruchthausen (Importer) Warehouses
Nature of product	Grape juice
Nominal package content	1000 millilitre (ml)
Density of product rho	1.013 g/ml
Lot size	110 packages
Extent of test	13 packages (sample) destructive test
Mean tare value	5.83 g

**Content of individual packages in millilitre**

The values stated within brackets ( ) are gross values of tests in gram

Values with \* are below Tu 1 = 985 ml, with \*\* are below Tu 2 = 970 ml

1. Package :	973.9 (992.4) *	2. Package :	1003.2 (1022.1)
3. Package :	998.4 (1017.2)	4. Package :	995.4 (1014.2)
5. Package :	993.4 (1012.1)	6. Package :	996.4 (1015.1)
7. Package :	998.3 (1017.1)	8. Package :	992.5 (1011.3)
9. Package :	990.6 (1009.3)	10. Package :	988.6 (1007.3)
11. Package :	985.7 (1004.4)	12. Package :	980.9 (999.5) *
13. Package :	961.3 (979.6) **		

**Conformity of the mean value :**

Mean value of sample  $\bar{x}$  : 989.13 ml

Standard deviation s : 11.48 ml

Corrected mean value of sample  $\bar{x}_0 = \bar{x} + k \cdot s$  (k = 0.847)

$\bar{x}_0 = 998.85$  ml (rounded to 999 ml)

**Mean value too low by 1 millilitre****Conformity of low limits**

Number of packages below Tu 1 : 3 (admissible : 1)

whereof below Tu 2 : 1 (admissible : 0)

## DANEMARK

# LEGAL METROLOGY in DENMARK 1683-1982

by H. Blichfeldt, L. Rosenkilde and B.F. Sørensen  
DANTEST, National Institute for Testing and Verification

*SUMMARY — The organisation of metrology in Denmark is in full development. The present paper summarizes the historical evolution and describes the administrative and technical liaisons existing by the end of 1982. The changes foreseen for the near future will be subject to another paper in the Bulletin.*

*RESUME — L'organisation de la métrologie au Danemark est en pleine évolution. L'article ci-dessous donne un aperçu de l'évolution historique et décrit les liens administratifs et techniques en vigueur à la fin 1982. Les changements à prévoir dans un proche avenir feront l'objet d'un autre article dans le Bulletin.*

### 1. Historical review

Until the end of the 17th century many attempts had been made in Denmark and Norway to stop the chaotic situation with numerous local unit systems for weights and measures.

After the introduction of the absolute monarchy the young King Christian V issued on 1st of May 1683 a royal decree to the effect, that measurements for length, volume and mass should be unified throughout the Danish-Norwegian realm.

Ole Romer (1644-1710), professor in astronomy and mathematics who also determined the velocity of light, was entrusted with the manufacture of original standards and with the establishment of a « test office », which had to test and approve all instruments to be « stamped or branded », i.e. authorized for use. Fifteen years later - in 1698 - two sets of original standards for mass, length and volume were finished.

One set was kept by the municipal authority of the city of Copenhagen which at the same time together with four other towns, Aarhus and Aalborg in Denmark, Bergen and Christiania (Oslo) in Norway, obtained the monopoly to verify and deal in measuring instruments used for trade. The second set of original standards was placed in the custody of the « Commerce Collegio » (ministry of trade) and later transported to the royal castle of Rosenborg.

After 15 years of experience, Ole Romer was able to prepare a far more elaborate decree issued in 1698 and virtually forming the basic regulations until 1907. This decree dealt not only with the verification work, but also with standards and their preservation as well prescriptions for the choice of material and design for

measuring instruments, but strange enough not a word was said about permissible errors in verification, although such were proposed to the King by Ole Romer.

The steady development was suddenly interrupted in 1728, when a conflagration devastated the major part of Copenhagen and destroyed the original standards at the Town Hall. At the same time, the Rosenborg set seems - for unknown reasons - to have been forgotten. Therefore, in 1734, a completely new set of standards was established. At the end of the 18th century two more towns, Odense and Ribe, were granted authority for verification.

During the 19th century, the need for more well-defined and accurate standards, compatible to those of other European countries, arose. Thus, in 1835, the Danish ell (unit of length) was set to be equal to two « Berliner Feet », and, in 1839, the Danish pound was redefined to be exactly one half of the French kilogram, which only affected the former pound by fractions of gram.

In 1907 a new act introduced the metric system in Denmark to become effective in 1912. At the same time, the responsibility for verification was withdrawn from the municipal authorities and a National Bureau of Weights and Measures (NBWM) \* was established directly under the Ministry of Trade. Moreover, the new legislation emphasized the supervision of measuring instruments used in trade.

## **2. The existing legal background**

The « Act on Weights and Measures » was revised again in 1950 and this act constituted the legislation in Denmark until 31 December 1982.

The purpose of the revision was partly to modernize the act in accordance with the general technical development, and partly to intensify the control of measuring instruments used for trade, based on the fact that surveys of such instruments had indicated an unacceptable situation.

The result was, that the police was charged with the regular periodic inspection of weighing machines in retail shops, and that the relative small staff of technicians at the Bureau was supplemented with some 30 inspectors placed in all parts of the country.

Another new feature was the introduction of periodical verification of various measuring instruments, e.g. legal weights.

According to this legislation the National Bureau of Weights and Measures deals with all measuring instruments used for trade in the field of length, mass, and volume of liquids. It can be mentioned, however that town gas meters and cold water meters are approved and verified by the municipal works only. This will probably be changed in the near future, in connection with a new act on metrology, which comes into force from 1 January 1983. The scope and objectives of this new act will be the subject of a later article in this Bulletin.

## **3. Establishment of DANTEST and reorganisation of the NBWM on 1 January 1980**

Legal metrology in Denmark, as in most other countries, has been conducted by means of pattern evaluation and subsequent pattern approval of instruments

---

\* Abbreviation used for the purpose of this paper. The name in Danish has been Justervaesenet, abbreviated Jv.





Figure 1  
Old Danish weight standards

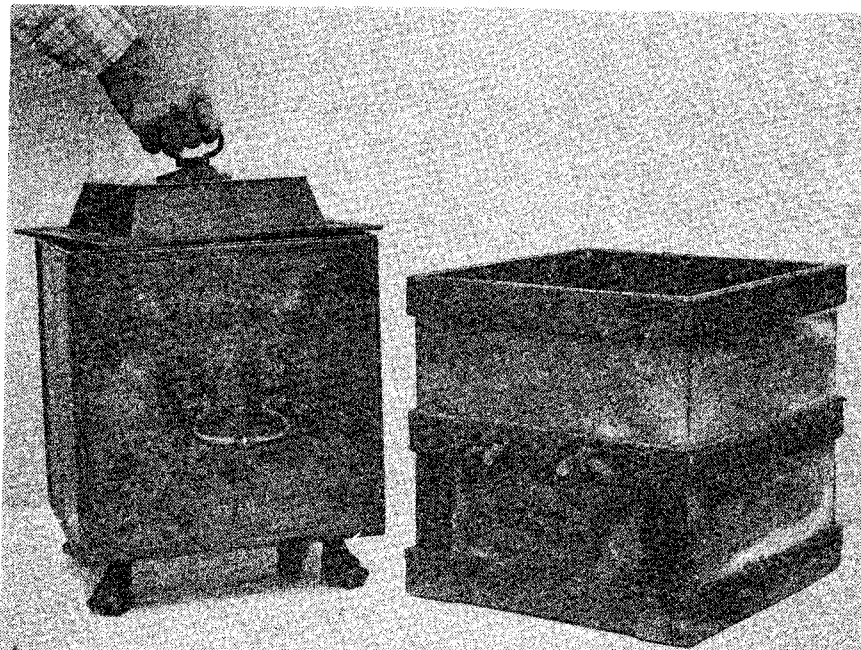

Figure 2  
Old Danish cubic feet standards

combined with initial verification followed either by subsequent periodic verification or by periodic inspection examination all confirmed by sealing and stamping the instrument as approved for legal use. This work was until the end of 1979 performed by the NBWM.

By 1 January 1980 DANTEST National Institute for Testing and Verification was established as an independent institute merging together the National Institute for Testing Materials and the main part of the NBWM. This part included the metrology laboratories with staff and all the inspectors in the field.

The practical work is now performed by DANTEST under the legal responsibility of the NBWM, which also issues the regulations and technical directives for legal metrology. Applications for pattern approval are submitted to the NBWM, which after evaluation of the documentation by order from the Ministry of Industries directs DANTEST to perform the examination and testing required.

Initial verification and subsequent periodic verification or inspection examination etc. are also performed by DANTEST. This means that at the moment the NBWM and DANTEST in common form the legal metrology organization in Denmark. Other institutes may, however, be involved in such testing for which they have specialized.

This actual arrangement and the procedures and equipment involved will be described in the following chapter.

#### **4. Legal Metrology Organization 1982**

The complete range of the responsibility of the NBWM is as follows :

- A. Technical Administrative
  - A 1. Regulations - administrative and technical directives
  - A 2. Pattern approval
  - A 3. Coordinating technical authority - relations to EEC and the Nordic countries
  - A 4. International cooperation - OIML, EEC and the Nordic countries
- B. Testing
  - B 1. Pattern evaluation
  - B 2. Verification
  - B 3. Calibration
- C. Inspection Examination
  - Compulsory inspection examination in situ (free of charge).
- D. Production/Sale
  - D 1. Production, adjustment and verification of weights for use in trade.
  - D 2. Sale of measuring instruments in accordance with an old national monopoly (weights, volumetric measures, length measures and steelyards).

##### **4 A. Technical - administrative functions**

As mentioned in the previous chapter, the NBWM issues the regulations for legal instruments concerning length, mass and volume of liquids. This work is

## LEGAL METROLOGY IN DENMARK 1982

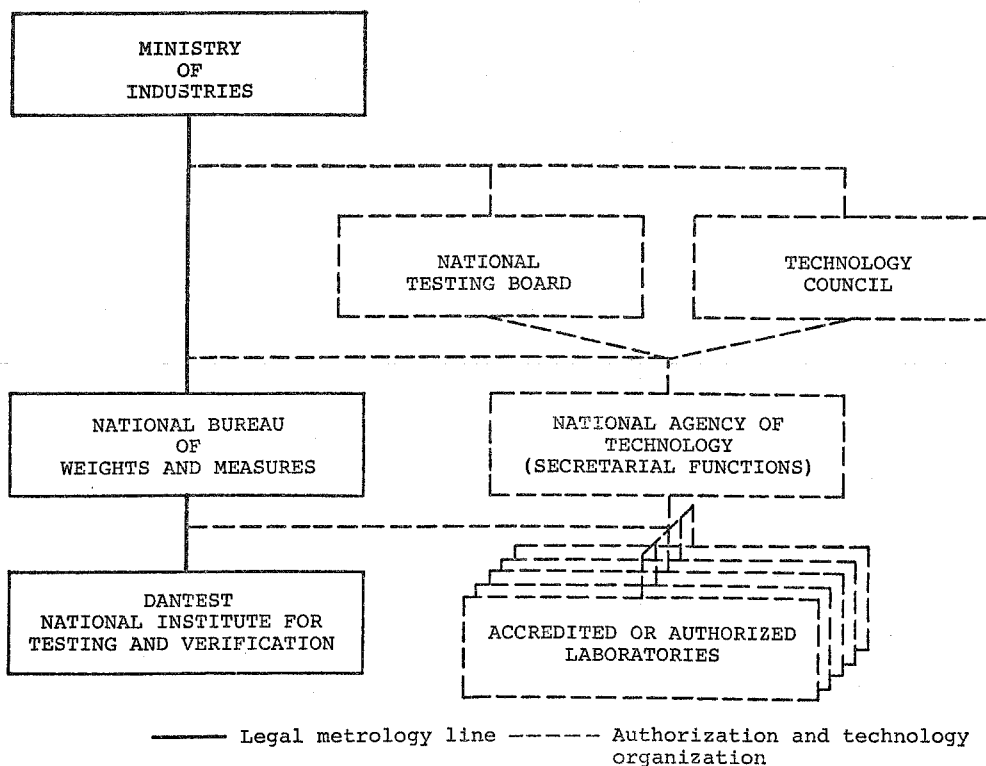

Figure 3

based on OIML recommendations and the EEC directives, which Denmark as a member state is obliged to implement as Danish legislation.

The pattern approval based on the pattern evaluation performed by and reported from DANTEST is issued by the NBWM as approving authority.

The NBWM follows the metrological activities in OIML, the Nordic countries, EEC, etc. and coordinates the Danish participation in these international activities. In order to ensure a technically qualified representation in the various working groups, NBWM often calls upon specialists from DANTEST to act as Danish representatives.

### 4 B. Testing

The pattern evaluation is performed in the DANTEST laboratories, but the test work is conducted in contact with the NBWM staff in order to be able to correct the course of action in the light of the results obtained. All results are compiled and reported to NBWM for final decision. The verification work is carried out either in the laboratories of DANTEST, or externally under supervision of an inspector from DANTEST and with standards periodically tested and calibrated by DANTEST.

Volume meters for liquids are verified at least once a year, weights at least once in 3 years, and volumetric measures at least once in 4 years.

As a basis for the pattern evaluation and verification work DANTEST maintains calibration facilities related to length, mass and volume, as described in chapter 5.

#### 4 C. Inspection examination

This activity is performed periodically on a 4 year schedule, and therefore it concerns mainly weighing machines, for which no periodical verification is prescribed.

The inspection is carried out by DANTEST inspectors, and financed by a special grant through the NBWM, which means that it is free of charge for the owner the instrument.

#### 4 D. Production/Sale

The supply of certain measuring instruments to the market is a historically based obligation, which is likely to disappear in 1983 under the new legislation. These instruments are produced by subcontractors and only the adjustment, verification and sale are carried out by DANTEST.

### 5. DANTEST organization, metrology laboratories and special metrological equipment

#### DANTEST ORGANIZATION

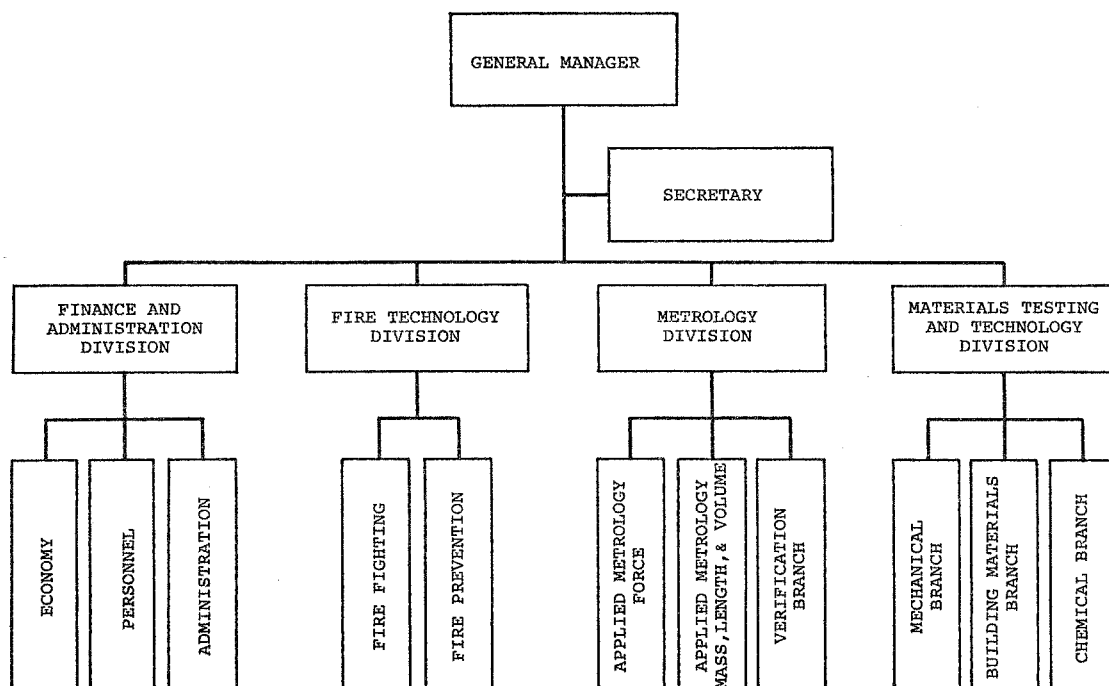

Figure 4

The whole spectrum of DANTEST activities is shown in the organization plan (fig. 4). The legal metrology constitutes the main task of the metrology division. However, some related activities are also placed there.

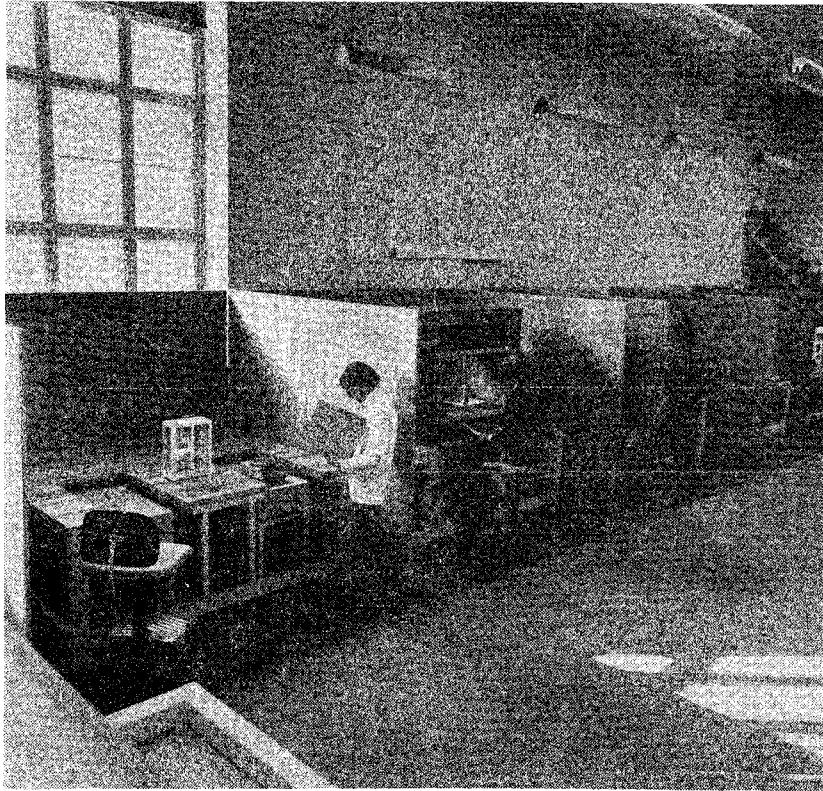

Figure 5

DANTEST laboratory for mass and force

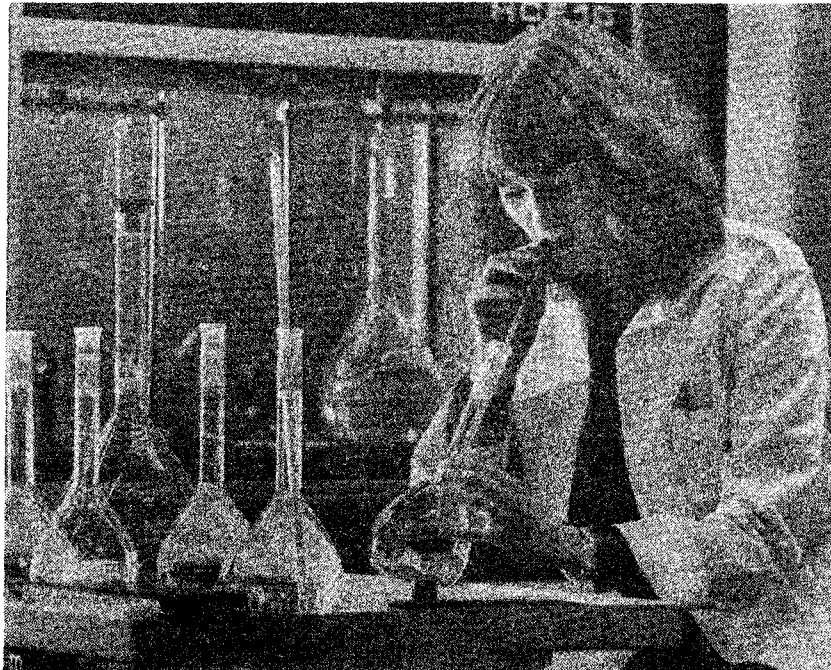

Figure 6

Gravimetric calibration of small volumetric measures

## 5.1 Verification branch

For the testing of weighbridges a special vehicle is used (lorry with trailer), carrying a number of 1 000 kg standard weights up to total weight of 43 ton (fig 8). The total wheel base (lorry with trailer) is 12 meters.

## 5.2 Applied metrology branch I - II

Laboratories for

- Calibration of masses up to 1 000 kg
  - Calibration of materialized length measures using a specially constructed 20 m measuring machine (See « OIML Bulletin » No. 76, September 1979)
  - Calibration of force in the range 1 000 kN Compression 200 kN Tension
  - Calibration of manometers in the range up to 3 500 bar
  - Pattern examination of legal instruments such as weighing machines and volume meters
- A climatic chamber with a floor space  $2 \times 3$  m and height 3 m, covering the temperature range from  $-10^{\circ}\text{C}$  to  $+40^{\circ}\text{C}$  is installed in this laboratory
- Calibration of densitometers for natural gas in the range  $1 \text{ kg/m}^3 - 80 \text{ kg/m}^3$  (under running - in)
  - Measurements of the compressibility of gas mixtures

Out of other activities which are not directly connected to a laboratory one may mention the testing of slot machines and supervision of workshops authorized to install and repair tachographs in vehicles.

## 6. Accreditation and authorization

Fig. 3 also shows the Danish authorization system. Based on the approval of the « National Testing Board » qualified laboratories are authorized in various fields of testing and calibration.

This arrangement has been built up in the seventies, and a number of both official and private laboratories have been authorized according to the regulations.

DANTEST has already obtained authorization for a number of its testing and calibration activities, but the legal work today is performed on the basis of a departmental accreditation and not a formal authorization, allowing NBWM to use DANTEST for this work.

In the future when the new act will be operative, the legal work is likely to be safeguarded by authorized laboratories, when the operations are suited for the already established authorization rules. If some areas are not suited for this system, accreditation of laboratories on another basis might be a solution to the problem.

Through the « Technology Council » (fig. 3) it is possible to obtain financial support for projects and technological development also in the field of metrology.

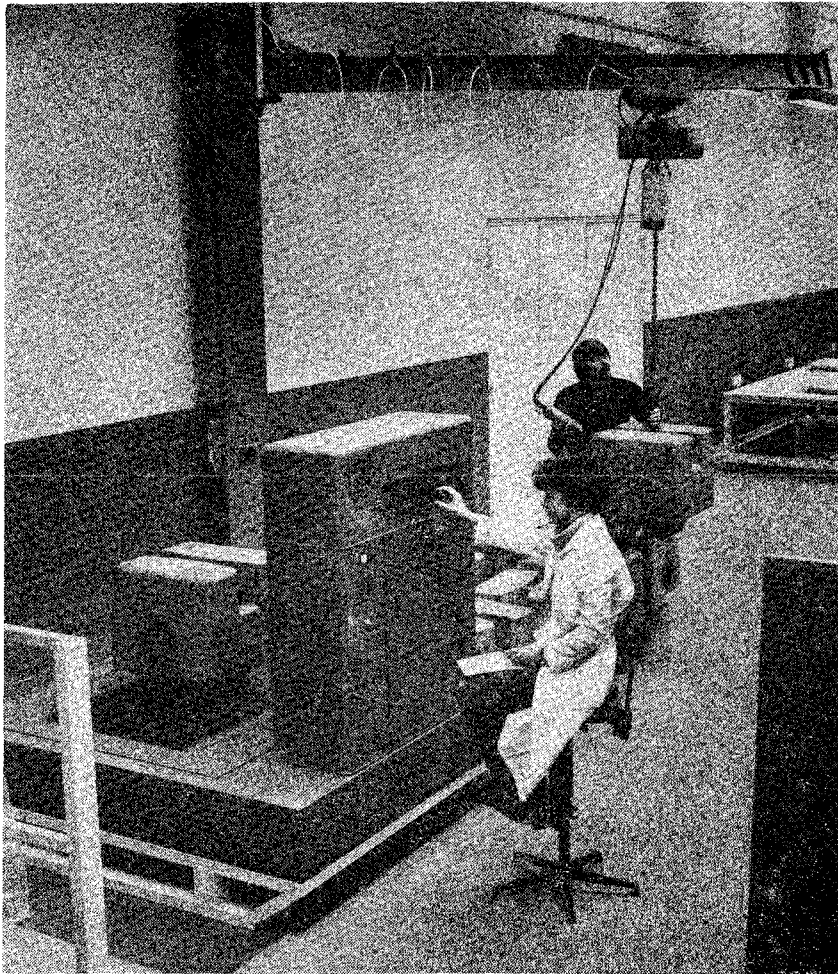

Figure 7 — Calibration of 1 000 kg weights

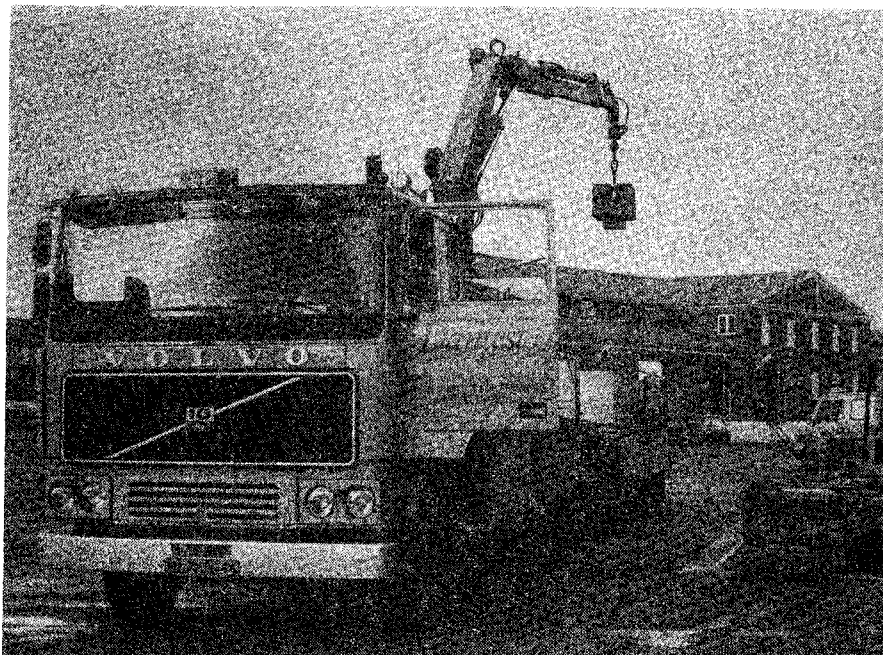

Figure 8 — Vehicle with 1 000 kg weights for verification of weighbridges (total 43 ton)

ROUMANIE

## DEADWEIGHT STANDARD MACHINES for STATIC TORQUE MOMENT REPRODUCTION

by V. LAMBERT \* and N. FÎNTÎNARU \*\*

*SUMMARY — Torque dynamometers are largely used in industry to measure the output characteristics of motors and engines and for setting the torque of various mechanical devices including safety devices, fixed torque wrenches, etc.*

*Precision torque dynamometers are nowadays frequently consisting of deformable cylinders equipped with strain-gauge, inductive or potentiometric transducers connected to an electrical indicating or recording devices.*

*The calibration of such torque dynamometers requires special machines by which the unit of torque can be reproduced to the required accuracy.*

*This paper describes two such machines having the capacity of 50 Nm and 6 kNm and by which the static torque moment is reproduced from the basic quantities - length and force. These deadweight machines are of constant arm length - variable load type. Both machines are used as standards and have an accuracy of 0.05 %.*

*RESUME — Les couple-mètres dynamométriques sont couramment utilisés dans l'industrie pour mesurer les caractéristiques de moteurs et pour le réglage du couple de divers dispositifs de sécurité tels que clefs dynamométriques, etc.*

*Les couple-mètres de précision sont souvent constitués par des tubes cylindriques déformables équipés de capteurs à jauge contrainte, à potentiomètre ou à inductance variable reliés à un indicateur ou enregistreur électrique.*

*L'étalonnage de couple-mètres de ce type nécessite l'emploi de bancs d'étalonnage permettant de reproduire l'unité de couple avec l'exactitude requise.*

*Cet article décrit deux bancs de ce type de capacité 50 Nm et 6 kNm dans lesquels un couple statique peut être obtenu à partir des grandeurs de base : longueur et force. Ces bancs sont du type à bras constant et charge variable.*

*Les deux bancs sont employés en tant qu'étalons avec une exactitude de 0,05 %.*

### 1. General considerations

A force torque moment is the product of a quantity (length) expressed in the basic SI-unit of measurement - the meter - and another quantity (force) expressed in the derived SI-unit - the newton - consequently the SI-unit of torque moment is expressed in Nm.

Continued research work done in the Laboratories of the Timisoara Branch of the National Institute of Metrology in Bucharest [8], aiming at the development of

\* Zwick GmbH and Co. Material Testing Machines, POB 4350, D-7900 Ulm, F.R. of Germany.

\*\* National Institute of Metrology, Sos. Vitan-Bîrzesti 11, sector 4, R-75669 Bucharest 61, Romania.



direct loading deadweight standard machines [9] and the introduction of the SI-System [2], has resulted in two machines having capacities of 50 Nm and 6 kNm respectively which are mainly used for torque-dynamometer calibration whereby the static torque moment is reproduced from the two basic quantities, length and force [4, 6, 7].

The force component of the torque unit in these standard machines is provided by means of deadweights freely suspended from one end of a rigid beam. These weights are subjected to the local gravity acceleration which must be known in order to establish the exact value of the force applied. A slight upthrust of the surrounding air on the weights has also to be taken into account. The distance between the point of application of force and the fulcrum (axis of oscillation) is equal to the length of the torque arm.

Thus, a standard machine constructed on the above principle is composed - schematically - of a support on which the torque-dynamometer to be calibrated is mounted, an equal-arm beam and a pair of loading yokes with deadweights applied to one or the other end of the beam in order to produce positive or negative moments. Loading-unloading of the yoke is carried out by means of a movable rack supporting the deadweights.

An analysis of feasible solutions of construction [3, 4] has shown that an optimum loading scheme should ensure progressive loading steps, complete separation between the freely suspended yoke and the frame of the machine, as well as balancing of the beam in horizontal position for all torque steps used. The new types of torque measuring standard machines as reported below were developed on the basis of these requirements.

## 2. The 50 Nm standard machine

The 50 Nm standard machine [1] is illustrated by the drawing figure 1, the left part of which is a view from the end of the beam and the right part a front view. The machine is composed of a frame 1 with a movable support 10 for the torque dynamometer 12 to be calibrated. The latter is secured by means of the coupling flanges 11. A hand-wheel, not shown in the figure, displaces by means of a worm-gear the support 10 to allow the fitting of torque-dynamometers up to 350 mm in length.

The column 2 supports the beam 3 which can be arrested and have its central knife-edge 19 lifted off the bearing plane 18 by the device 13. The load is applied in steps to the beam through the buckles 4 from two racks 5 containing the deadweights 14.

Both weight racks are restrained and guided by the pulleys 7 between two cylindrical columns 25 mounted on the supports 6. The racks can be lowered vertically by a hand-wheel attached to the worm 27 forming part of the loading mechanism 8 which allows deposition of the weights on the tray 15 of the rod 24 without oscillation. The left part of figure 1 shows all the weights deposited on the rack whilst the right part of the figure shows all the weights supported on the suspended tray.

The weights are suspended on bearings 23 and end knife edges 20. The sensitivity of the beam is adjusted by the nut 21 and its balance by the nuts 22. The distance between the central knife-edge and each of the external knife edges is adjusted to  $500 \pm 0.1$  mm.

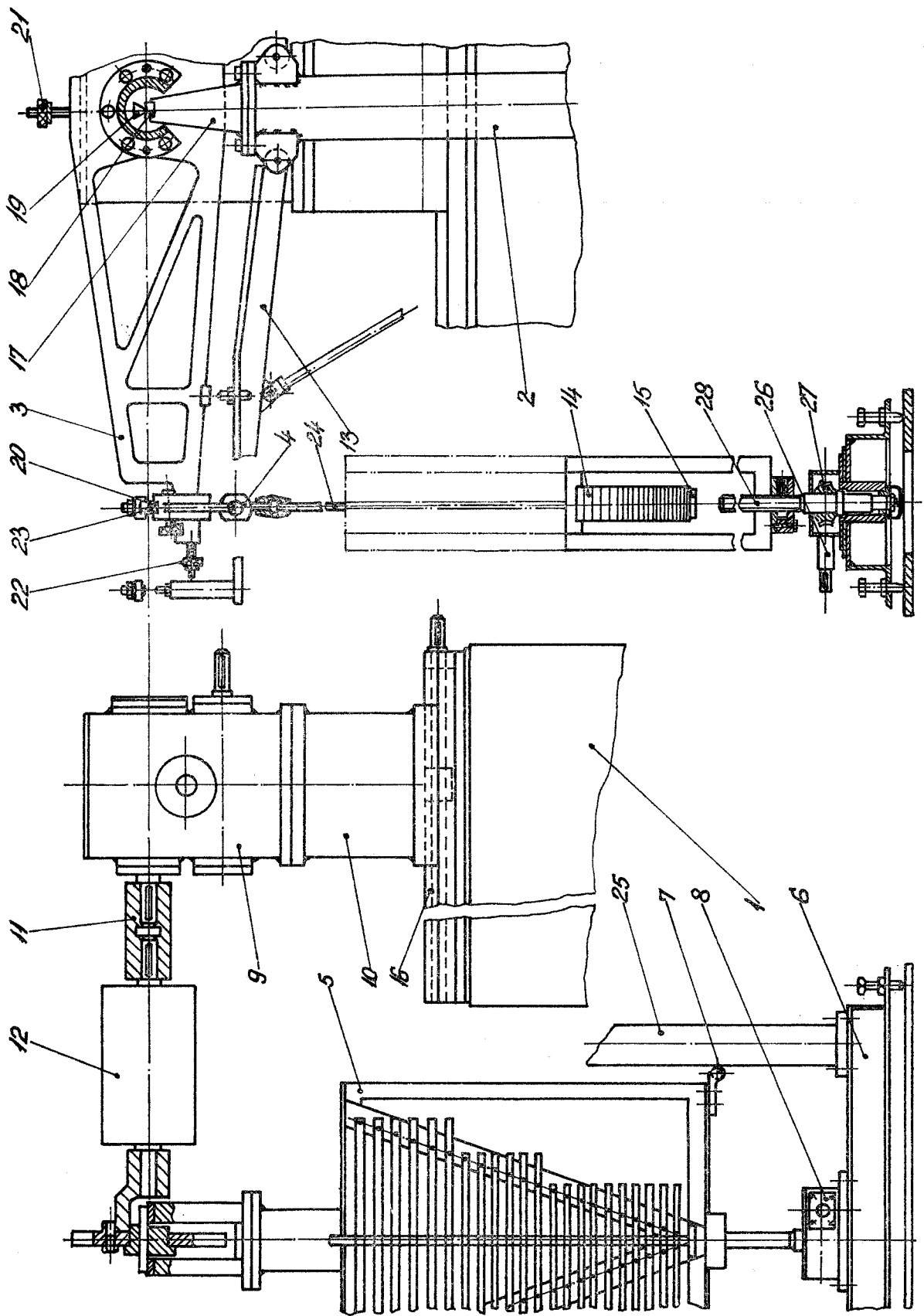

Figure 1  
The 50 Nm standard

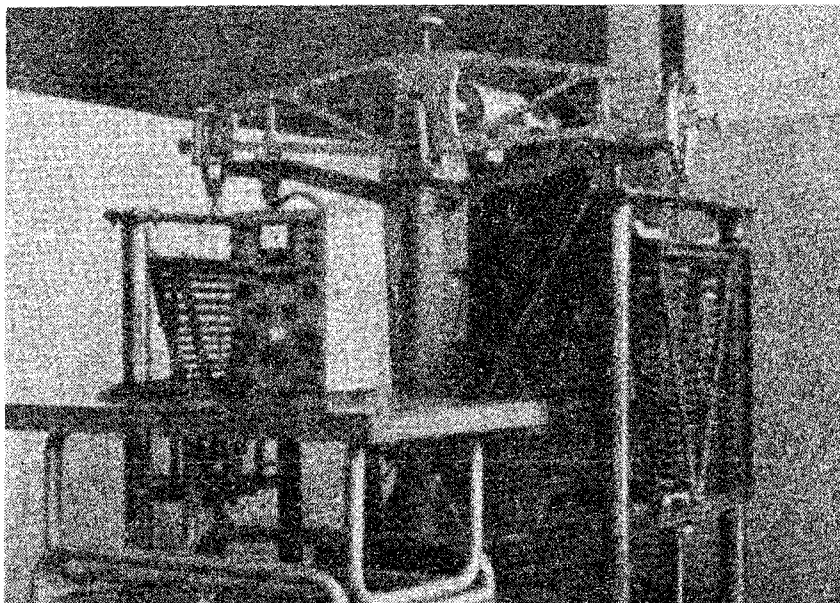

Figure 2  
Frontal view of the 50 Nm standard

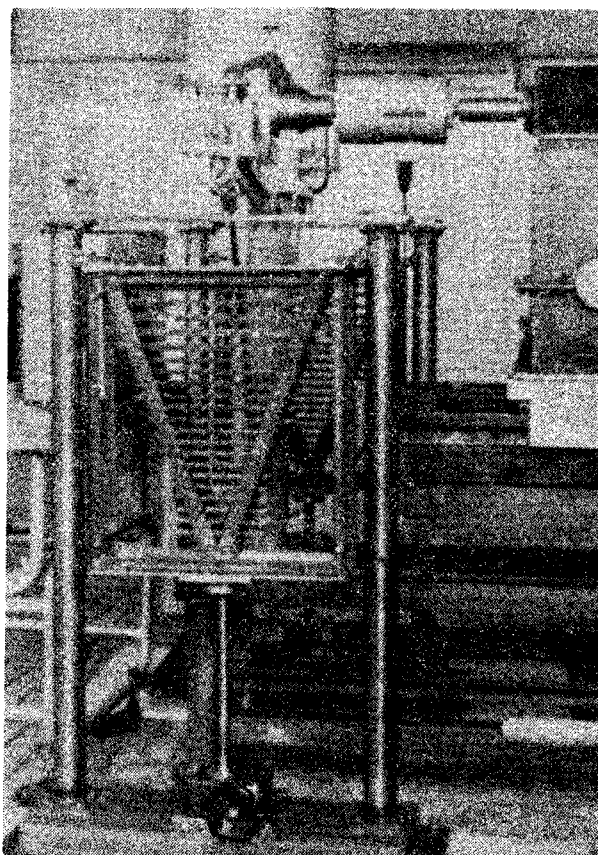

Figure 3  
Lateral view of the 50 Nm standard

The loading racks \* are each provided with twelve weights for 2 N load steps, four weights for 4 N load steps and six weights for 10 N load steps so that 22 steps of successive torque values up to a total of 50 Nm can be achieved. The gravity effects on both the suspended rods and trays are balanced and do not contribute to the load.

The machine is provided with a balancing device **9** allowing the horizontal position of the beam to be reached irrelevant of the torque applied. This device comprises a worm-axle system actuated by an electric motor which is brought into operation for each torque step applied so as to maintain the beam **3** perfectly horizontal during measurements. The horizontal position is monitored by means of an indicator which is not shown in the figure.

For torque-dynamometer calibration, the required coupling flanges are selected and secured into the standard machine. The beam is then adjusted and balanced for the measurements to be effected and locked in position by means of the arrestment device. The torque-dynamometer is installed with one end in the beam flange, the other being secured to the flange of the balancing device **9** by adjusting its movable support. Due consideration should be given to concentric mounting. While the torque-dynamometer is mounted and centered, the beam is unlocked by lowering the central knife edge onto its bearing plane, without however loading the end knife-edges **20**. Then the load steps are established depending on the capacity of the torque-dynamometer and the beam is completely freed while the end knife-edges are loaded up to the initial loading step and the inclination of the beam due to the applied weights is recorded.

The balancing device is then electrically actuated till an identical moment of opposite direction is obtained, corresponding to the horizontal position of the beam, while the angle of torsion of the torque-dynamometer remains constant. The output reading of the torque-dynamometer taken at the initial torque step applied is recorded and the next torque application is made by repeating the above operations. After the torque-dynamometer has been loaded up to the rated torque value, the output reading whilst unloading is recorded, the same operations being carried out in the reverse order. Figs. 2 and 3 show front and side views of the 50 Nm standard machine not operational, i.e. the dead weights are on the racks and the beam is lifted.

### 3. The 6 kNm standard machine

The 6 kNm standard machine is shown in fig. 4, side, front and top views [5]. The machine is composed of a frame **1** (a lathe base) provided with a pair of strong supports **2** and **3** and a pair of guide rails **14** for horizontal movement of a saddle **10** holding the balancing device **11** and the electromechanical actuation device **12** which also can be actuated by a hand-wheel.

The torque-dynamometers to be calibrated - which can be of various lengths are mounted between the flanges **13** by displacing the saddle by means of a rack and pinion (not shown) and a hand-operated wheel **16**.

The torque moment is created by the equal-arm beam **5**, the ends of which are fitted with a yoke and tray **17**, which during calibration is loaded with deadweights **18** from racks **8** and **9**, by means of the loading devices **19** and **20**. The side view in fig. 4 shows the yoke **17** loaded with the deadweights, while the front view illustrates the machine not operational (weights **18** on rack **8**).

The beam is fitted with a central knife-edge supported on a bearing plane **22** rigidly fixed to the support **4**. The ends of the beam are fitted each with adjustable

---

\* Designed by R. GARTNER (†) and I. HANER.

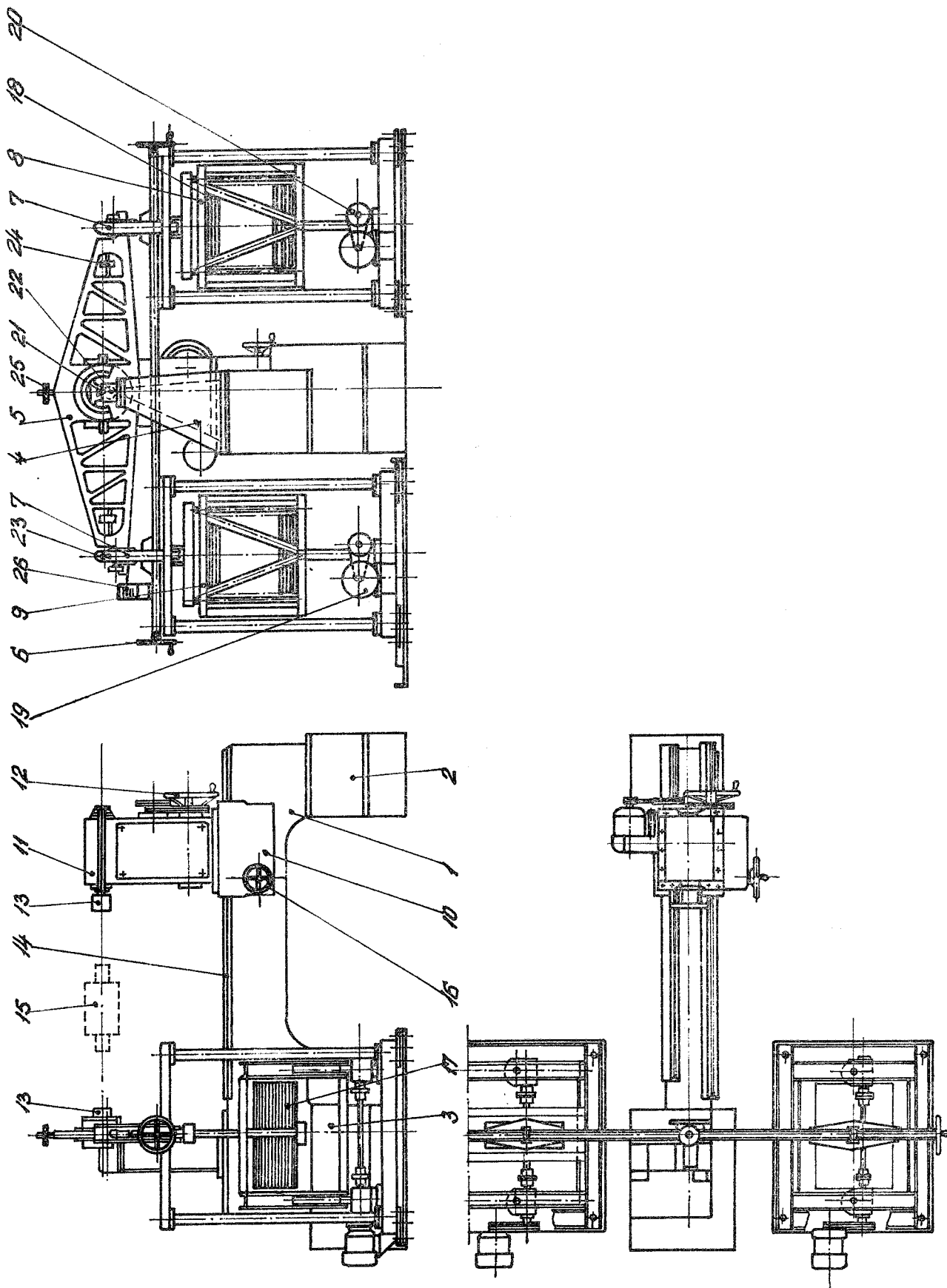

Figure 4  
The 6 kNm standard

knives and balancing nuts ; the central nut **25** is used for sensitivity adjustments. The central knife-edge **21** and both end knife-edges **23** are located, by design, in the same horizontal plane.

Starting from the rest position the beam is lifted off its central bearing by means of the arrestment device **6** which first unloads the end knife-edges by lifting the yokes with the trays **17** and subsequently the beam. These operations are carried out by means of connecting brackets **7** and conical nuts (not shown) being moved in opposite directions by the right and left-hand threads on the arrestment device axle.

The electric motor-operated loading devices **19** and **20** permit deposition of deadweights **18** onto the trays **17**, in two ways, according to requirements, by lowering the racks **8** and **9**. Depending on the capacity of the torque-dynamometer to be calibrated, the pair of racks A or B is mounted into the machine as follows :

— racks A provided with a series of weights called « small » for 15 loading steps up to 1 kNm,

— racks B provided with a series of weights called « great » for 14 loading steps up to 6 kNm.

Since the length of the load arm is  $1\ 000 \pm 0.1$  mm (distance between central knife-edge and one end knife-edge) the moment values obtained are numerically equal to the values of deadweights applied.

The balancing device **11** is composed of a lever system (not shown), actuated by an electric motor \*, by which the torsion stress is transmitted to the fixing flange **13** at one end of the torque-dynamometer **15** to be calibrated. The other end of the torque-dynamometer is secured to a second flange **13**, the distance between the two flanges being adjusted by means of the saddle **10**. The fixing flanges **13** are located coaxially with the central knife-edge.

One of the beam ends is fitted with a photoelectric cell system **26** \*\* allowing for the automatic adjustment of the beam in horizontal position irrelevant of the value of the loading steps applied to the torque-dynamometer.

The torque-dynamometer to be calibrated is mounted and centered between the flanges **13** with simultaneous actuation of the arrestment device **6** by means of which the beam is lowered onto the central knife-edge. Following this, one of the trays is loaded with the initial load step by actuation of rack **8**, which by lowering deposits weights on the tray **17**. Because of the moment generated the beam shows a tendency to incline toward the side of the weights applied, this tendency being immediately sensed by the photoelectric cell control system **26**. When the balancing device **11** is actuated the system **26** automatically brings the beam back to its horizontal position, while the angle of torsion of the torque-dynamometer remains constant. In this situation the output reading of the torque-dynamometer is recorded and the next loading step is applied.

It should be noted that measurement of the relevant values during unloading is also possible with the standard machine, the same operations being performed in the reverse direction. Calibration can be made, if required, for the opposite loading direction too (negative moment), by loading the opposite beam arm.

Fig. 5 shows a general view of the 6 kNm standard machine with small weights (rack A) mounted, and fig. 6 with small weights placed on rack A and yoke unloaded. The rack B is shown to the right with holders for large weights B. The calibration of a Hottinger torque-dynamometer is shown in fig. 7. The mounting of the torque-dynamometer into the standard machine is shown in fig. 8.

\* Developed by M. CHEVERESAN and I. MATKOVITS.

\*\* Developed by I. SMEJKAL, V. BURCA, M. POMIRLAN, I. PAZSITKA and A. KAUREK.

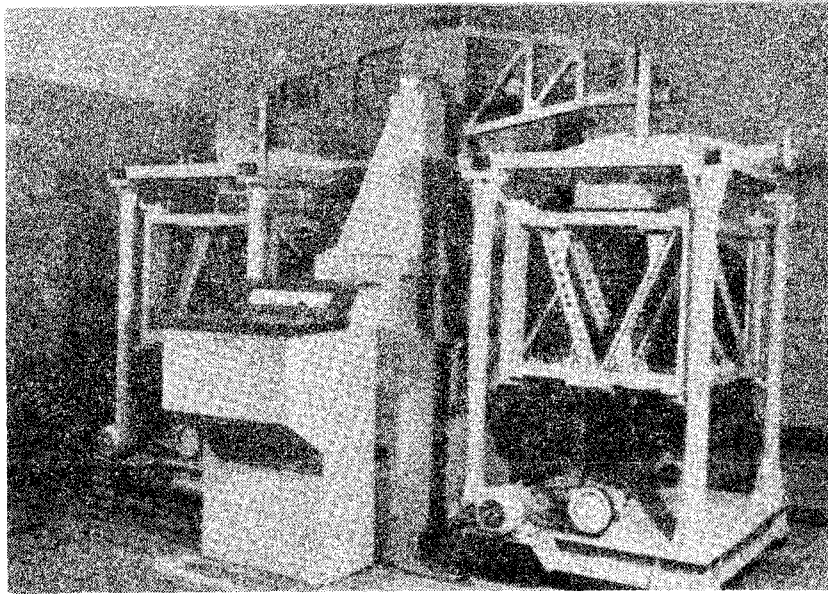

Figure 5  
General view of the 6 kNm standard

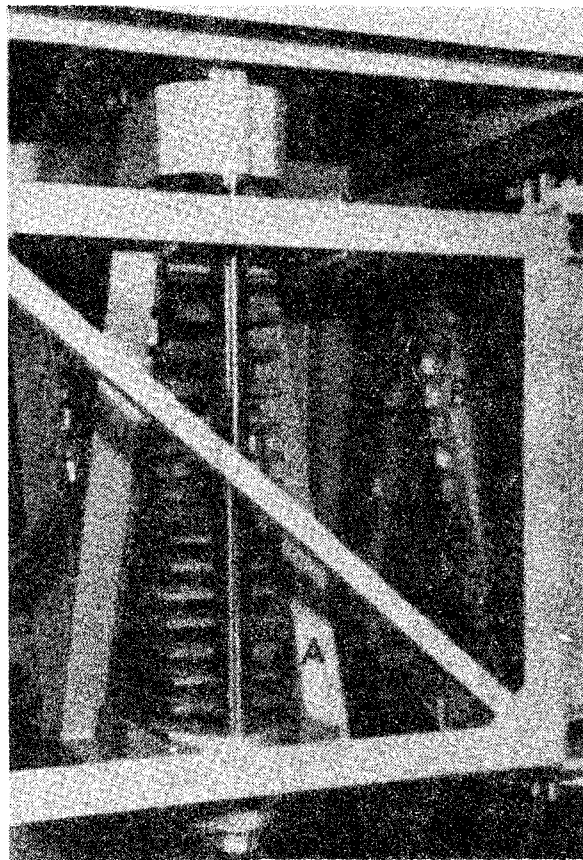

Figure 6  
Small weights deposited on rack A, yoke unloaded

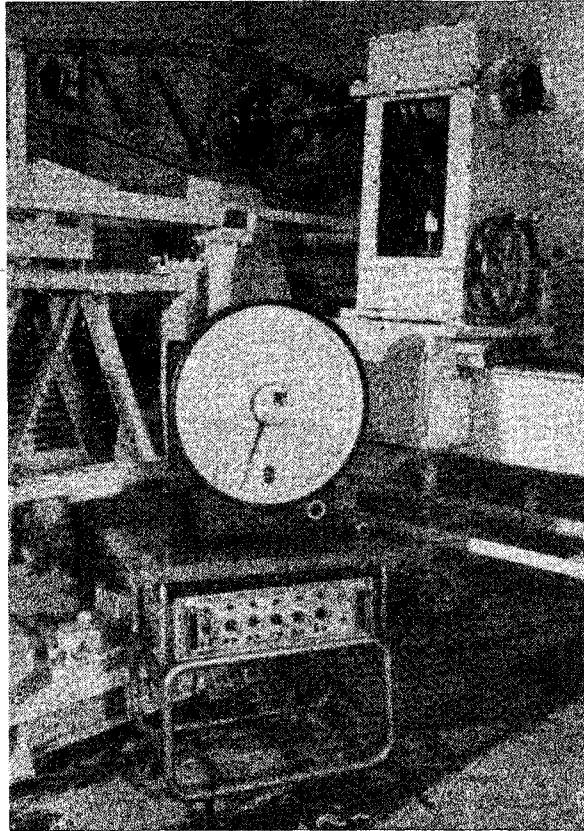

Figure 7 — Calibration of a Hottinger transducer

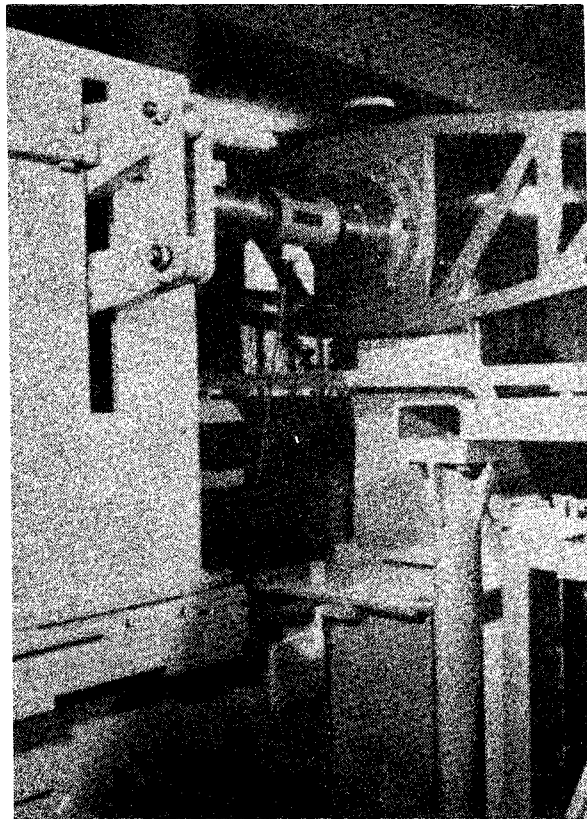

Figure 8 — Detail of transducer mounting



#### 4. Torque moment reproduction accuracy

From the relation defining moment  $M = LG$ , where  $M$  = torque moment  $L$  = torque arm length and  $G$  = force applied to the arm, the maximum relative error of torque moment measurements is obtained from [3]

$$\frac{\Delta M}{M} = \frac{\Delta L}{L} + \frac{\Delta G}{G}$$

The length of the beam arm was determined with an accuracy of  $\pm 0.1$  mm, so that the relative error for  $L = 500$  mm or  $L = 1\,000$  mm, is respectively

$$\frac{\Delta L'}{L} = \frac{\pm 0.1}{500} = \pm 2 \cdot 10^{-4} \text{ and } \frac{\Delta L'}{L} = \frac{\pm 0.1}{1\,000} = \pm 1 \cdot 10^{-4}$$

The influence of knife-edge displacement because of beam deflection under load applied, is obtained by taking a maximum deflection of 2.5 mm for the 500 mm lever arm and 5 mm for the 1 000 mm arm. In this case the length of the horizontal projection of the deflected arm is shorter by less than 0.025 mm, or 0.05 mm than the actual arm length, while relative error is :

$$\frac{\Delta L''}{L} \leq \frac{0.025}{500} = 0.5 \cdot 10^{-4} \text{ and } \frac{\Delta L''}{L} \leq \frac{0.05}{1\,000} = 0.5 \cdot 10^{-4}$$

The influence on the arm length at 20 °C of a temperature change from 20 °C can be estimated by assuming a maximum variation of  $\pm 2$  °C and using the coefficient of expansion for the steel  $\alpha = 1.23 \cdot 10^{-5} \text{ } ^\circ\text{C}^{-1}$ .

The resulting relative error is then :

$$\frac{\Delta L'''}{L} = 1.23 \cdot 10^{-5} (\pm 2) = \pm 0.25 \cdot 10^{-4}$$

Thus, the total relative error for 500 mm or 1 000 mm arm length, may be estimated to be :

$$\frac{\Delta L}{L} = \sqrt{\left(\frac{\Delta L'}{L}\right)^2 + \left(\frac{\Delta L''}{L}\right)^2 + \left(\frac{\Delta L'''}{L}\right)^2}$$

which gives

$$\frac{\Delta L}{L} \cong 2.08 \cdot 10^{-4} \text{ and } \frac{\Delta L}{L} \cong 1.15 \cdot 10^{-4}$$

The deadweight calibration was made [1][3] under the most disadvantageous conditions to an accuracy of  $\pm 0.00005$  N for a load of 2 N with the 50 Nm machine, and to  $\pm 0.05$  N for a load of 500 N with 6 kNm machine, resulting in the following relative errors

$$\frac{\Delta G}{G} = \pm \frac{0.00005}{2} = \pm 0.25 \cdot 10^{-4} \text{ and } \frac{\Delta G}{G} = \pm \frac{0.05}{500} = \pm 1 \cdot 10^{-4}$$

The theoretical accuracy of torque moment reproducibility for the 50 Nm standard machine is thus

$$\frac{\Delta M}{M} = \frac{\Delta L}{L} + \frac{\Delta G}{G} = 2.08 \cdot 10^{-4} + 0.25 \cdot 10^{-4} = 2.33 \cdot 10^{-4} = 0.0233 \%$$

and for the 6 kNm standard machine :

$$\frac{\Delta M}{M} = 1.15 \cdot 10^{-4} + 1 \cdot 10^{-4} = 2.15 \cdot 10^{-4} = 0.0215 \%$$

During operation, however, the actual accuracy is affected by friction and eccentricity. For this reason, and to ensure a certain safety factor, the practical accuracy is being assumed to be equal to slightly more than twice these values, i.e. 0.05 %.

## 5. Technical characteristics and performances

The technical and metrological performances of the standard machines developed are summarized, in the following table.

No.	Designation of characteristic	Values, specifications	
		50 Nm machine	6 kNm machine
1.	Minimum moment	1 Nm	50 Nm
2.	Maximum moment	50 Nm	6 kNm
3.	Torque steps obtainable	multiples of 1 ; 2 ; 5 Nm	racks A multiples of 50 ; 100 Nm racks B multiples of 0.25 ; 0.5 ; 1 kNm
4.	Sign of torque moment	positive or negative	positive or negative
5.	Direction of application	loading or unloading	loading or unloading
6.	Length of load arm	2 × 500 mm	2 × 1000 mm
7.	Load steps applied	multiples of 2 ; 4 ; 10 N	multiples of 50 ; 100 ; 250 ; 500 ; 1000 N
8.	Distance between fixing flanges	50 ... 350 mm	50 ... 1300 mm
9.	Distance between guide rails and axis of torque-dynamometer to be calibrated	400 mm	750 mm
10.	Actuation of loading devices	hand-operated	two motors 220/380 V ; 1.1 kW ; 1410 r/min
11.	Actuation of balancing device	motor 220/380 V ; 0.6 kW ; 1460 r/min	motor 220/380 V ; 0.75 kW ; 1380 r/min
12.	Accuracy of accomplishment of torque arm length	± 0.1 mm	± 0.1 mm
13.	Relative deadweight calibration accuracy	0.25 · 10 <sup>-4</sup>	1 · 10 <sup>-4</sup>
14.	Torque reproduction accuracy	5 · 10 <sup>-4</sup> = 0.05 %	5 · 10 <sup>-4</sup> = 0.05 %
15.	Temperature change permitted	20 ± 2 °C	20 ± 2 °C

**References** (papers in Romanian language)

- [1] FINTINARU N.; MATKOVITS I. Development of calibration method and device for small-torque transducers 5-50 Nm. National Institute of Metrology Bucharest, Timisoara Branch, 1974 (internal report).
- [2] ISCRULESCU I.; ISPASOIU G.; PETRESCU V. The International System of Units of Measure. Editura Tehnica, Bucharest 1970.
- [3] LAMBERT V.; FINTINARU N. Torque moment measurement. National Institute of Metrology Bucharest, Timisoara Branch, 1967 (internal report).
- [4] LAMBERT V. Installations for the precise calibration of torque measuring equipment. Metrologia aplicata XV, 3, p. 104, Bucharest 1968.
- [5] LAMBERT V. Torque moment calibration machine. Patent certificate No. 54023/10-3-72, titular INMB Editura Tehnica, Bucharest 1972.
- [6] LAMBERT V. Metrological regulations for torque moment measurements. Metrologia aplicata XV, 8, p. 357, Bucharest 1968.
- [7] LAMBERT V. Torque moment reproduction in Romania. Metrologia aplicata XV, 12, p. 533, Bucharest 1968.
- [8] RATIU M. Achievements of the Timisoara Branch of the National Institute of Metrology Bucharest. Metrologia aplicata XIII, 8-9, p. 386, Bucharest 1966.
- [9] RATIU M. Machine with separate loading device for dynamometer calibration. Metrologia aplicata XII, 1, p. 9, Bucharest 1965.

# ENSEIGNEMENT de la MÉTROLOGIE

## LITTÉRATURE

### Balances manométriques

Nous avons le plaisir d'annoncer la récente parution d'un ouvrage sur les balances manométriques :

The Pressure Balance. Theory and Practice  
by R.S. DADSON, S.L. LEWIS, G.N. PEGGS  
National Physical Laboratory (Grande-Bretagne), 290 pages  
London, Her Majesty's Stationery Office, 1982.

Ce livre traite d'une façon très complète des problèmes pratiques et théoriques associés à la construction, l'utilisation, les corrections et l'étalonnage des balances manométriques avec 178 références à des ouvrages concernant des mesures de pression, y compris d'autres types de manomètres.

Nous signalons à cette occasion, également, un ouvrage plus condensé publié précédemment :

The Pressure Balance. A practical Guide to its use  
by Sylvia LEWIS and G.N. PEGGS  
National Physical Laboratory, 63 pages  
London, Her Majesty's Stationery Office, 1979

### PTB - Liste de publications

Le PTB vient de publier un fascicule contenant la liste des rapports et autres publications récentes établie par son service de publications :

Publications of the Physikalisch- Technische Bundesanstalt  
compiled by Referat Schriftum, PTB-L-17  
24 pages, Braunschweig, Juni 1982

### Métrologie de masses

Nous avons reçu du Canada un fascicule en français et anglais traitant des problèmes théoriques associés à l'étalonnage de séries de poids étalons :

Progrès en métrologie des étalons de masse  
(avec un historique)  
par M. ROMANOWSKI et G. MIHAÏLOV  
2 × 27 pages, 1re édition août 1981

Cette publication peut être obtenue, sans frais, auprès du Ministère de la Consommation et des Corporations du Canada, Direction de la Métrologie légale, Tunney's Pasture, Ottawa (Canada) K1A 0C9.

# METROLOGY EDUCATION

## LITERATURE

### Pressure balances

We have pleasure in announcing a recently published book :

The Pressure Balance. Theory and Practice  
by R.S. DADSON, S.L. LEWIS, G.N. PEGGS  
National Physical Laboratory (Great Britain), 290 pages  
London, Her Majesty's Stationery Office, 1982.

This book gives a complete, practical and theoretical treatment of all essential problems associated with the construction, use, correction and calibration of pressure balances as well as 178 references to publications dealing with pressure measurement including other types of manometers.

We take the opportunity to remind about another more condensed book previously published :

The Pressure Balance. A practical Guide to its use  
by Sylvia LEWIS and G.N. PEGGS  
National Physical Laboratory, 63 pages  
London, Her Majesty's Stationery Office, 1979

### PTB - List of publications

The PTB laboratories has issued a booklet containing the list of reports and other recent publications :

Publications of the Physikalisch- Technische Bundesanstalt  
compiled by Referat Schrifttum, PTB-L-17  
24 pages, Braunschweig, Juni 1982

### Mass metrology

We have received from Canada a booklet in French and English dealing with the theoretical problems of the calibration of sets of mass standards :

New developments in the metrology of mass standards  
(with historical introduction)  
by M. ROMANOWSKI and G. MIHAILOV  
2 × 27 pages, first edition, August 1981

This publication is available, without charge, from Department of Consumer and Corporate Affairs Canada, Legal Metrology Branch, Tunney's Pasture, Ottawa, Canada K1A 0C9.

## **INFORMATION**

### **SEMINAR ON PRECISION MEASURING INSTRUMENTS IN ENGINEERING INDUSTRIES**

Dresden, 20-24 September 1982

This seminar was organised by the United Nations Economic Commission for Europe and was essentially devoted to mechanical engineering metrology.

OIML was represented by Mr LIERS, the CIML member of the German Democratic Republic.

We are overleaf reproducing a list of the papers presented, reprints of which may be requested from

United Nations  
Economic Commission for Europe  
Palais des Nations  
CH-1211 Genève 10  
Switzerland.

LIST OF PAPERS PRESENTED AT THE UN/ECE SEMINAR ON  
PRESENT USE AND PROSPECTS FOR PRECISION MEASURING  
INSTRUMENTS IN ENGINEERING INDUSTRIES

<b>Symbol</b>	<b>Title of paper</b>	<b>Author(s)</b>	<b>Country or organization</b>
R.1	Optical procedures for the measurement of surface roughness	R.-J. AHLERS	Federal Republic of Germany
R.2	Control of the accuracy of a multi-co-ordinate measuring machine	W. KNAPP	Switzerland
R.3	The use of co-ordinate measuring devices for the measurement of revolving surfaces	S. PAULY and T. KIRCHNER	Federal Republic of Germany
R.4	Unit transfer to industrial length-measuring devices on the basis of the metre definition	K. SCHMIDT	German Democratic Republic
R.5	Requirements on inter-changeability and measuring engineering for the automated manufacture of high-quality products in engineering industries	H. TRUMPOLD	German Democratic Republic
R.6	Problems of parameters, reference systems and measuring methods for form deviations explained by means of examples of cylindricity	E. HELDT	German Democratic Republic
R.7	The development of automation and precision in optical instrumentation	K. MUTZE and H. POHLACK	German Democratic Republic
R.8	Application of light and electron-optical instruments for measuring small dimensions in microlithography	R. PLONTKE	German Democratic Republic
R.9	Application of photogrammetry in industrial metrology	K. SZANGOLIES and K. REGENSBURGER	German Democratic Republic
R.10	Application of measuring systems to improve the quality of grinding machines	W. BAHMANN, J. WALDE and C. LIEBERWIRTH	German Democratic Republic
R.11	The increase in production and quality by means of precision-measuring instruments and micro-computers - an education and training problem	D. HOFMANN	International Measurement Confederation (IMEKO)
R.12	Computer-aided co-ordinate measurement for quality control	W. LOTZE and P. VOGEL	German Democratic Republic
R.13	Problem-oriented programming languages - a support for effective computer application to co-ordinate measurements	G. STILLER, M.W. HARTMANN and H. LOEPER	German Democratic Republic
R.14	Applications of engineering surveying in the construction of machines and installations	F. DEUMLICH and H. WERNER	German Democratic Republic
R.15	Equipment for the measurement of blanks and its application in automated production systems	A. SEDLAR	Czechoslovakia
R.16	Integration of control of the production process and product quality in automated engineering production	A. SEVCIK	Czechoslovakia



Symbol	Title of paper	Author(s)	Country or organization
R.17	Integration of measurement and control in the operating process of a grinding machine	M. RUZICKA	Czechoslovakia
R.18	The State system of metrology and the commercial metrology service in the G.D.R.	H.W. LIERS	German Democratic Republic
R.19	Holographic measuring techniques in the machine industry	Z. FUZESSY	International Measurement Confederation (IMEKO)
R.20	Measuring systems, techniques and applications of photogrammetry in industry and research	G. HELL	Federal Republic of Germany
R.21	The role of quality control and its connection to the information processes in flexible manufacturing	G. HERMANN and L. NEMES	Hungary
R.22	Electronic measuring equipment in engineering industries and its development	R. FRANCESCHI	Italy
R.23	An integrated system of computer aided design and production	H. WILLEM and D. MULLER	German Democratic Republic
R.24	Application of measuring systems for ensuring the geometric and technological quality of part manufacture in manufacturing cells used in low-attended operations	A. RUSSIG and R. GRABNER	German Democratic Republic
R.25	In-process measurement of workpiece and tools	T. PFEIFER, A. FURST and W. VOLLAARD	International Measurement Confederation (IMEKO)
R.26	Use of precision transducers (« Inductosyn » type) for measuring movement in numerically-controlled machine tools	N.A. SMIRNOV, A.I. SMUROV and A.N. CHERNOGORSKY	Union of Soviet Socialist Republics
R.27	The worker-instrument interface: the view of the International Labour Organisation	K.-H. EBEL	International Labour Organisation (ILO)
R.28	The new Swedish organization for metrology standards and calibration and its co-operation with industry	C. GORANSSON	Sweden
R.29	Contamination control in fine precision industries	R. KRATEL	Federal Republic of Germany
R.30	Interpolation error of linear inductosyns in different operating conditions	V. DRAJEV, A. IVANTSCHEV, D. GETZKOVSKA, I. KRIVORADEV, P. PENTSHEV and T. KANTSHEVA	Bulgaria
R.31	New technical solutions by application of induction transducers	D. GETZKOVSKA and P. SHOLZ	Bulgaria and the German Democratic Republic
R.32	In situ metrology system for a large CNC diamond turning machine	W.J. WILLS-MOREN	United Kingdom
R.33	Production, imports and exports of professional precision instruments, broken down by commodity groups, for selected countries, 1975-1979 (statistical data)	ECE secretariat	

**METROLOGY RESEARCH ORGANISED  
BY THE COMMISSION OF THE EUROPEAN COMMUNITIES**

A number of research programmes within the field of reference materials and applied metrology has been launched by the Commission of the European Communities.

Details are given in the status report for 1981 entitled « Programme on reference materials and applied metrology » which may be purchased from the Office for official publications of the European Communities, Batiment Jean Monnet, Luxembourg.

From the index of this report we are below reproducing the titles of the research programmes within the field of applied metrology. The publication also gives details of more than 40 other subjects related to reference materials among which one may mention comparative measurements of hardness scales and reference gas mixtures for analyses related to pollution.

**GEOMETRICAL & MECHANICAL METROLOGY**

Intercomparison of volumetric measures (portable measures)  
Intercomparison of large proving tanks  
Intercomparison of force standards  
Intercomparison of differential pressure measurements at high line pressure  
Intercomparison and calibration of vacuum gauges in the range  $8 \times 10^{-5}$  to  $8 \times 10^{-2}$  Pa  
Reference helium leaks  
Intercomparison of three accelerometers  
Automation of gauge blocks calibration  
Three coordinate measurements intercomparison  
Intercomparison of solid density standards

**FLUID FLOW MEASUREMENTS**

Intercomparison of high-pressure gas flow test facilities  
Development of a transfer standard for hot water flow measurements  
Orifice plate discharge coefficient  
Study of the correlation of calibration curves at low pressure and high pressure of turbine gas meters  
Calibration of sonic nozzles as transfer standards for high pressure gas flow measurements  
Characterisation of performance of a pipe-prover and intercomparison of measurements  
Intercomparison of liquid petroleum gas meter test facilities  
Investigation of the stability of turbine meters for heat metering

**TEMPERATURE & HUMIDITY**

Sealed cell for the temperature at the melting point of sodium  
Gallium sealed cells  
Intercomparison of noble metal thermocouples between 1 000 °C and 1 600 °C  
Improvement of standards for industrial temperature measurement above 1 500 °C  
Low temperature dew point hygrometer  
Medium range temperature dew point hygrometer  
Rationalisation of the metrological control of moisture meters in service

## OPTICAL METROLOGY

Development of a Deuterium lamp as a transfer standard for spectral radiance  
Determination of the ratio of luminous flux of discharge lamps to the luminous flux of reference incandescent lamps

## ELECTRICAL & MAGNETIC MEASUREMENT

Intercomparison of ac electric power measurements  
Intercomparison measurements of thermal ac/dc transfer standards  
Manufacturing and calibration of multijunction ac/dc thermal convertors  
Intercomparison of the calibration of an ac and of a dc voltage divider  
Intercomparison of electrical resistance measurements  
Intercomparison measurements of capacitance and loss factors at high voltages  
Intercomparison of precise differential-phase measurements  
Development of a precision broadband coaxial noise source at 700 K noise temperature and in a frequency range of 0.1 GHz to 10 GHz  
Intercomparison of radio frequency and microwave power flux density monitors  
Pressure sensitivity calibration of microphones by the reciprocity technique  
Intercomparison of measurements on ear protectors by subjective and objective methods  
Study and synthesis of the measurements of electric perturbations in the low voltage power lines in the countries of the European Community  
Intercomparison of testing sites for motor vehicles by means of a reference generator of electromagnetic noise  
Precise magnetic measurements on electrical sheet steel  
Time synchronisation via OTS-2  
Calibration of ultrasonic transducer sensitivity and power by laser interferometry  
Development of ultrasonic standard transducers for the frequency range 1 MHz to 10 MHz  
Preliminary evaluation of two types of small diameter hydrophones

## REUNIONS

Groupes de travail	Dates	Lieux
SP 11 - Sr 3 Balances manométriques	22-24 févr. 1983 (provisoire)	BRATISLAVA TCHECOSLOVAQUIE
SP 5 - Sr 2 Schémas de hiérarchie des étalons de volume	28 févr.-4 mars 1983	TOKYO JAPON
SP 5 - Sr 3 Mesures de volumes de laboratoires		
SP 5 - Sr 20 Méthodes et dispositifs de vérification des instruments de mesure de liquides		
SP 16 - Sr 2 Laboratoires secondaires d'étalonnage en dosimétrie	25-27 avril 1983	BUDAPEST HONGRIE
SP 12 - Sr 8 Compteurs d'énergie thermique	31 mai-2 juin 1983	BERLIN-OUEST
SP 19 - Sr 2 Machines d'essai des matériaux	13-15 juin 1983 (provisoire)	BIML
SP 27 Principes généraux de l'utilisation des matériaux de référence en métrologie légale	2e trimestre 1983	MINSK U.R.S.S.
SP 7 - Sr 2 Généralités. Dispositifs électroniques (mesure des masses)	19-23 sept. 1983	WASHINGTON U.S.A.
SP 7 - Sr 4 Instruments de pesage à fonctionnement non automatique		
SP 30 Mesures physico-chimiques	26 sept.- 1er oct. 1983	TBILISSI U.R.S.S.
SP 30 - Sr 2 Conductométrie		
SP 30 - Sr 4 Hygrométrie des matériaux solides		
SP 30 - Sr 9 Viscosimétrie		
SP 30 - Sr 10 Analyse des gaz		
SP 5 - Sr 16 Compteurs d'eau	automne 1983 (provisoire)	EAST KILBRIDE ROYAUME-UNI
SP 22 Principes du contrôle métrologique	automne 1983 (provisoire)	PARIS FRANCE
<hr/>		
Groupe de travail mixte BIPM-CEI-ISO-OIML : « Vocabulaire International de Métrologie »	2-4 févr.	PARIS FRANCE
Dix-neuvième réunion du Comité International de Métrologie Légale	3-5 mai 1983	COPENHAGUE DANEMARK
Séminaire OIML sur les produits préemballés suivi des réunions du SP 20 Produits préemballés	6-8 juin 1983	BERNE SUISSE
(et de ses Secrétariats-rapporteurs)	9-10 juin 1983	BERNE SUISSE

## CENTRE DE DOCUMENTATION

### Documents reçus au cours du 4e trimestre 1982

#### ORGANISATION INTERNATIONALE DE NORMALISATION — ISO

##### Documents généraux (fr. et angl.)

- Liaisons (4e édition, 1982)
- Catalogue 1982, Supplément 2 (Juillet 1982)
- Résolutions du Conseil, Répertoire 1947-1981 (6e édition, 1982)
- Directives pour les travaux techniques de l'ISO (13e édition, 1982)
- Répertoire des Organismes internationaux à activités normatives (3e édition, 1982)
- Programme à long terme de l'ISO pour le développement pour 1983-1985 ratifié par le Conseil de l'ISO, sept. 1982
- Manuel pour le développement 2 : Le fonctionnement d'un système de certification (1re édition, 1982)
- Normalisation et développement, 1979
- Avantages de la Normalisation, 1982

##### ISO Normes (fr. et angl.) :

- ISO 156-1982 : Matériaux métalliques - Essai de dureté - Contrôle des machines d'essai de dureté Brinell
- ISO 409/1-1982 : Matériaux métalliques - Essai de dureté - Tableaux des valeurs de dureté Vickers pour utilisation dans les essais effectués sur surfaces planes - Partie 1 : HV 5 à HV 100
- ISO 410-1982 : Matériaux métalliques - Essai de dureté - Tableaux des valeurs de dureté Brinell pour utilisation dans les essais effectués sur surfaces planes
- ISO 3719-1982 : Machines à équilibrer - Symboles pour les tableaux de commande
- ISO 6251-1982 : Gaz de pétrole liquéfiés - Action corrosive sur le cuivre - Essai à la lame de cuivre
- ISO 6507/1-1982 : Matériaux métalliques - Essai de dureté - Essai Vickers - Partie 1 : HV 5 à HV 100
- ISO 6527-1982 : Centrales nucléaires - Echanges de données de fiabilité - Critères généraux
- ISO 7145-1982 : Détermination du débit des fluides dans les conduites fermées de section circulaire - Méthode par mesure de la vitesse en un seul point

#### ORGANISATION DES NATIONS UNIES POUR L'EDUCATION, LA SCIENCE ET LA CULTURE — UNESCO

- L'informatique, facteur vital de développement, 1982
- Nouveau périodique d'information :  
Enseignement technique et professionnel N° 2/1982

#### COMMISSION ELECTROTECHNIQUE INTERNATIONALE — CEI

- Complément au catalogue des publications (Juin 1982)
- 2e complément au catalogue des publications (Sept. 1982)

#### ORGANISATION DES NATIONS UNIES POUR L'ALIMENTATION ET L'AGRICULTURE / ORGANISATION MONDIALE DE LA SANTE — FAO/OMS

- Joint FAO/WHO Food Standards Programme, Codex Alimentarius Commission
- CAC/RS 1-1969 : Norme Générale Internationale recommandée pour l'étiquetage des denrées alimentaires préemballées

#### INTERNATIONAL INFORMATION CENTRE FOR TERMINOLOGY — INFOTERM

- Nouveau périodique reçu :  
Term net News N° 4/5 - 1982

COMMISSION DES COMMUNAUTES EUROPEENNES — CCE

Nouveau périodique reçu :

Bulletin de renseignements documentaires : depuis A26, 1982

Bureau Communautaire de référence

bcr information : Programme on reference materials and applied metrology,  
Status report 1981 (EUR 7811 EN, 1982)

Catalogue of BCR Reference Materials, Brussels - 1982

CONSEIL D'ASSISTANCE MUTUELLE ECONOMIQUE — SEV

Ukazatel' Standartov SEV, 1982

REPUBLIQUE FEDERALE D'ALLEMAGNE

Physikalisch- Technische Bundesanstalt

PTB-Prüfregeln Band 10 : Lagerbehälter in Form stehender Zylinder, Teil 2 :  
Ergänzung (S. Raschke, 1982)

PTB-L-17 (Juni 1982) : PTB-Bericht, Schriften der PTB zusammengestellt vom Referat  
Schrifttum

AUSTRALIE

Commonwealth Scientific and Industrial Research Organisation

Division of Applied Physics - Biennial Report (July 1979 - June 1981)

AUTRICHE

Bundesamt für Eich- und Vermessungswesen

Amtsblatt für das Eichwesen : N° 1-4/1982 :

Mitteilung Nr. 39 über das Zeitsignal des Bundesamt für Eich- und Vermessungswesen (BEV), mai 1982

CUBA

Comite Estatal de Normalizacion. Aseguramiento metrologico :

NC 90-01-10 (3-1981) : Placas planas de vid ; Metodos y medios de verificacion

NC 90-01-26 (3-1981) : Medios de medicion de longitud y de angulo ; clasificacion  
general, Terminos y definiciones

NC 90-04-13 (3-1981) : Recipientes cilindricos horizontales con cabezas planas cir-  
culares ; Metodos y medios de verificacion (Metodo geometrico)

NC 90-06-03 (6-1981) : Instrumentos de pesar comerciales e industriales ; Clasifi-  
cacion general

NC 90-06-18 (6-1981) : Bascula de mesa « y ara » BM - 50 ; Especificaciones de  
calidad

NC 90-06-19 (6-1981) : Bascula de tolva con indicador e integrador ; metodos y  
medios de verificacion

NC 90-07-04 (6-1981) : Manometros, vacuometros y manovacuumetros registradores  
de deformacion elastica ; metodos y medios de verificacion

NC 90-09-07 (6-1981) : Maquina de ensayo de dureza super-Rockwell ; metodos  
ensayo de dureza super-Rockwell

NC 90-13-01 (9-1981) : Densimetros y areometros de trabajo ; clasificacion

NC 90-13-02 (9-1981) : Refractometros ; clasificacion

NC 90-13-17 (9-1981) : Densimetros y areometros ; Reglas generales para efectuar

NC 90-13-18 (9-1981) : Conductimetros ; clasificacion

NC 90-14-02 (3-1981) : Millivoltímetros pirometricos ; Metodos y medios de verifica-  
cion

NC 90-15-21 (6-1981) : Ohmímetros ; Metodos y medios de verificacion

NC 86-02 (3-1981) : Cereales ; granos y harinas ; Muestreo

NC 92-27 (3-1981) : Control de la calidad ; Inspeccion por atributos ; planes  
de muestro secuenciales

NC 92-28 (3-1981) : Control de la calidad ; Numeros preferidos y series de  
numeros preferidos para los valores de entrada de las tablas estadisticas

## DANEMARK

Justervaesenet

— Directives techniques danoises sur la métrologie de 1976 à 1981

## FINLANDE

Suomen Standard isoimisliitto

Standardi SFS 3700 (1976) : Metrologia. Mittaustekniikan Perussanasto (Metrology. Vocabulary of fundamental terms of metrology)

## FRANCE

Bureau National de Métrologie  
Rapport d'activité 1981

Réglementation métrologique

Arrêté du 8-2-1982 : Evaporateurs-répartiteurs de frais de chauffage

## PAYS-BAS

Dienst van het IJkwezen

IJkwetgeving III : Aanverwante wetten (Sept. 1982)

## POLOGNE

Polski Komitet Normalizacji Miar i Jakosci

Dziennik Normalizacji i Miar : Nr 3 - 11-1982

Zarządzenia nr 173 z dnia 31-12-1981 r. w sprawie utraty mocy aktów prawnych  
b. Prezesa Polskiego Komitetu Normalizacyjnego i b. Prezesa Polskiego Komitetu Normalizacji i Miar

## ROYAUME-UNI DE GRANDE-BRETAGNE ET D'IRLANDE DU NORD

National Physical Laboratory

NPL Report QU 48 (July 1978) : Electronic medical thermometers (by P.B. Coates)

NPL Report QU 64 (May 1982) : The design of a standards Laboratory for thermometry (by P.B. Coates)

NPL Report DNACS 35/80 (Oct. 1980) : The use of Chebyshev polynomials for the production of Spirits Tables (by P.E.M. Curtis and J.G. Hayes déjà publié dans le Bulletin de l'OIML N° 83, Juin 1981)

## SUEDE

Statens provningsanstalt

Svensk Mätplatskalender 1982

Föreskrifter för icke automatiska vagor avsedda för kröning den 17-5-1982 :

SPFS 1982:7 Pendelvagnar och pendelvagnar kombinerade med andra vagor

SPFS 1982:8 Over -och undervagnar

SPFS 1982:9 Elektroniska vagor

SPFS 1982:10 Fjädersvagnar

SPFS 1982:11 Vagnar för satsvägning

SPFS 1982:12 Specialvagnar

SPFS 1982:13 Skjutviktsvagnar i noggrannhetsklass 3 och 4

SPFS 1982:14 Likarmade vagor

SPFS 1982:15 Decimalvagnar i noggrannhetsklass 3 och 4

## SUISSE

Mettler Wägelexikon - Praktischer Leitfaden der wägetechnischen Begriffe (L. Bietry, M. Kochsiek - Mai 1982)

## TCHECOSLOVAQUIE

INSYMET 82

6. Medzinarodné Sympozium Metrologie (Bratislava 1982)

URSS

Gosudarstvennyi Komitet SSSR po Standartam

State System for ensuring the uniformity of measurements :

Gost 8.005-82 : Continuous balance conveyor. Methods and means of verification

Gost 8.031-82 : State primary Standard and state verification schedule for means of measuring neutron flux and its density

Gost 8.140-82 : State primary standard and state verification schedule for means of measuring heat conduction of solids in the range from 0.1 to 5 W at temperatures from 90 to 500 K and in the range from 5 to 20 W at temperatures from 300 to 1100 K

Gost 8.434-81 : Humidity of grain and its processing products. Method of carrying out measurements by dielectric and resistive moisturegauges

Gost 8.452-82 : Radioisotope X-ray devices. Methods and means for verification

Gost 8.453-82 : Balance for static weighing. Methods and means for verification

Gost 8.454-82 : State special standard and state verification schedule for means of measuring quantity of heat of solution and heat of reactions

Gost 8.455-82 : Measuring vibrating wire uniform force transducers type. Methods and means for verification

Gost 8.456-82 : Measuring vibrating wire fluid level transducers type. Methods and means for verification

Gost 8.457-82 : State primary standard and state verification schedule for means of measuring specific conductivity of solutions of electrolytes within the range from  $1.10^{-4}$  to  $1.10^2$  S/m

Gost 8.459-82 : Pitch difference measuring instruments. Methods and means for verification

Gost 8.461-82 : (ST SEV 1058-78) : Resistive temperature transducers. Methods and means for verification

Gost 8.463-82 : Measuring antennas. Measuring complex of apparatus. Methods and means for verification

Gost 8.465-82 : Actual frequency of limited accuracy. Methods and means for verification

Gost 8.466-82 : Mechanical marine chronometers. Methods and means for verification

Gost 8.467-82 : Normative technical documents relating to measurement procedures. Requirements to layout scope and wording

Gost 8.469-82 : Scale weighers of continuous action. Methods and means of verification



# RECOMMANDATIONS INTERNATIONALES

de la

## CONFERENCE INTERNATIONALE DE METROLOGIE LEGALE

R.I. N°	Secrétariats	Année d'édition
— Vocabulaire de métrologie légale (termes fondamentaux) (édition bilingue français/anglais)	Pologne	1978
1 — Poids cylindriques de 1 gramme à 10 kilogrammes (de la classe de précision moyenne)	Belgique	1973
2 — Poids parallélépipédiques de 5 à 50 kilogrammes (de la classe de précision moyenne)	Belgique	1973
3 — Réglementation métrologique des instruments de pesage à fonctionnement non automatique	R.F. d'Allemagne et France	1978
4 — Fioles jaugées (à un trait) en verre	Royaume-Uni	1970
5 — Compteurs de volume de liquides (autres que l'eau) à chambres mesureuses	R.F. d'Allemagne et France	1981
6 — Prescriptions générales pour les compteurs de volume de gaz	Pays-Bas et R.F. d'Allemagne	1978
7 — Thermomètres médicaux à mercure, en verre, avec dispositif à maximum	R.F. d'Allemagne	1978
8 — Méthode étalon de travail destinée à la vérification des instruments de mesurage du degré d'humidité des grains	R.F. d'Allemagne	1970
9 — Vérification et étalonnage des blocs de référence de dureté Brinell	Autriche	1970
10 — de dureté Vickers	Autriche	1970
11 — de dureté Rockwell B	Autriche	1970
12 — de dureté Rockwell C	Autriche	1970
14 — Saccharimètres polarimétriques	R.F. d'Allemagne	1978
15 — Instruments de mesure de la masse à l'hectolitre des céréales	R.F. d'Allemagne	1970
16 — Manomètres des instruments de mesure de la tension artérielle	Autriche	1970
17 — Manomètres - vacuomètres - manovacuumètres - indicateurs (instruments usuels)	U.R.S.S.	1981
18 — Pyromètres optiques à filament disparaissant	U.R.S.S.	1970

19 —	Manomètres - vacuomètres - manovacuumètres - enregistreurs (instruments usuels)	U.R.S.S.	1981
20 —	Poids des classes de précision E <sub>1</sub> E <sub>2</sub> F <sub>1</sub> F <sub>2</sub> M <sub>1</sub> de 50 kg à 1 mg	Belgique	1973
21 —	Taximètres	R.F. d'Allemagne	1973
22 —	Alcoométrie	France	1973
	— Tables alcoométriques	France	1975
23 —	Manomètres pour pneumatiques	U.R.S.S.	1973
24 —	Mètre étalon rigide pour Agents de vérification	Inde	1973
25 —	Poids étalons pour Agents de vérification	Inde	1977
26 —	Seringues médicales	Autriche	1973
27 —	Compteurs de volume de liquides autres que l'eau — Dispositifs complémentaires	R.F. d'Allemagne et France	1973
28 —	Réglementation « technique » des instruments de pesage à fonctionnement non-automatique	R.F. d'Allemagne et France	1981
29 —	Mesures de capacité de service	Suisse	1973
30 —	Mesures de longueur à bouts plans	U.R.S.S.	1981
31 —	Compteurs de volume de gaz à parois déformables	Pays-Bas	1973
32 —	Compteurs de volume de gaz à pistons rotatifs et compteurs de volume de gaz à turbine	R.F. d'Allemagne	1973
33 —	Valeur conventionnelle du résultat des pesées dans l'air	B.I.M.L.	1973
34 —	Classes de précision des instruments de mesurage	U.R.S.S.	1974
35 —	Mesures matérialisées de longueur pour usages généraux	Belgique et Hongrie	1977
36 —	Vérification des pénétrateurs des machines d'essai de dureté	Autriche	1977
37 —	Vérification des machines d'essai de dureté système Brinell	Autriche	1977
38 —	Vérification des machines d'essai de dureté système Vickers	Autriche	1977
39 —	Vérification des machines d'essai de dureté système Rockwell B,F,T — C,A,N	Autriche	1977
40 —	Pipettes étalons pour Agents de vérification	Inde	1977
41 —	Burettes étalons pour Agents de vérification	Inde	1977
42 —	Poinçons de métal pour Agents de vérification	Inde	1977
43 —	Fioles étalons graduées en verre pour Agents de vérification	Inde	1977
44 —	Alcoomètres et aréomètres pour alcool	France	1977

45 — Tonneaux et futailles	Autriche	1977
46 — Compteurs d'énergie électrique active à branchement direct	France	1978
47 — Poids étalons pour le contrôle des instruments de pesage de portée élevée	R.F. d'Allemagne et France	1978
48 — Lampes à ruban de tungstène pour l'étalonnage des pyromètres optiques	U.R.S.S.	1978
49 — Compteurs d'eau (destinés au mesurage de l'eau froide)	Royaume-Uni	1977
50 — Instruments de pesage totalisateurs continus à fonctionnement automatique	Royaume-Uni	1980
51 — Trieuses pondérales de contrôle et trieuses pondérales de classement	Royaume-Uni	1980
52 — Poids hexagonaux — Classe de précision ordinaire — de 100 grammes à 50 kilogrammes	Belgique et Royaume-Uni	1980
53 — Caractéristiques métrologiques des éléments récepteurs élastiques utilisés pour le mesurage de la pression. Méthodes de leur détermination	U.R.S.S.	1982
54 — Echelle de pH des solutions aqueuses	U.R.S.S.	1981
55 — Compteurs de vitesse, compteurs mécaniques de distance et chronotachygraphes des véhicules automobiles — Réglementation métrologique	Pologne	1981
56 — Solutions-étalons, reproduisant la conductivité des électrolytes	U.R.S.S.	1981
57 — Ensembles de mesurage de liquides autres que l'eau équipés de compteurs de volumes — Dispositions générales	R.F. d'Allemagne et France	1982

## DOCUMENTS INTERNATIONAUX

adoptés par le

**Comité International de Métrologie Légale**

D.I. N°

1 — Loi de métrologie	BIML	1975
2 — Unités de mesure légales	BIML	1978
3 — Qualification légale des instruments de mesurage	BIML	1979
4 — Conditions d'installation et de stockage des compteurs d'eau froide	Royaume-Uni	1981
5 — Principes pour l'établissement des schémas de hiérarchie des instruments de mesure	France	1982

Note — Recommandations internationales et Documents internationaux peuvent être acquis au Bureau International de Métrologie Légale, 11, rue Turgot, 75009 PARIS.

# ORGANISATION INTERNATIONALE DE MÉTROLOGIE LÉGALE

BUREAU INTERNATIONAL DE MÉTROLOGIE LÉGALE  
11, RUE TURGOT — 75009 PARIS — FRANC

## ETATS MEMBRES

ALGERIE	INDONESIE
REP. FEDERALE D'ALLEMAGNE	IRLANDE
REP. DEMOCRATIQUE ALLEMANDE	ISRAEL
AUSTRALIE	ITALIE
AUTRICHE	JAPON
BELGIQUE	LIBAN
BULGARIE	MAROC
CAMEROUN	MONACO
CANADA	NORVEGE
CHYPRE	PAKISTAN
REP. DE COREE	PAYS-BAS
REP. POP. DEM. DE COREE	POLOGNE
CUBA	ROUMANIE
DANEMARK	ROYAUME-UNI DE GRANDE-BRETAGNE ET D'IRLANDE DU NORD
EGYPTE	SRI LANKA
ESPAGNE	SUEDE
ETATS-UNIS D'AMERIQUE	SUISSE
ETHIOPIE	REP. UNIE DE TANZANIE
FINLANDE	TCHECOSLOVAQUIE
FRANCE	TUNISIE
GRECE	U.R.S.S.
GUINEE	VENEZUELA
HONGRIE	YUGOSLAVIE
INDE	

## MEMBRES CORRESPONDANTS

Albanie - Botswana - Colombie - Equateur - Fidji - Hong Kong - Irak - Jamaïque - Jordanie - Koweït -  
Luxembourg - Mali - Maurice - Nepal - Nouvelle-Zélande - Panama - Philippines - Portugal - Syrie -  
Trinité et Tobago - Turquie

# ORGANISATION INTERNATIONALE DE MÉTROLOGIE LÉGALE

BUREAU INTERNATIONAL DE MÉTROLOGIE LÉGALE

11, RUE TURGOT — 75009 PARIS — FRANCE

## MEMBRES

du

## COMITE INTERNATIONAL de METROLOGIE LEGALE

### ALGERIE

Membre à désigner par son Gouvernement

### REPUBLIQUE FEDERALE D'ALLEMAGNE

Mr W. MÜHE  
Chef des Bureaux Technico-Scientifiques,  
Physikalisch-Technische Bundesanstalt,  
Bundesallee 100  
3300 BRAUNSCHWEIG.

### REPUBLIQUE DEMOCRATIQUE ALLEMANDE

Mr H.W. LIERS  
Directeur de la Métrologie Légale,  
Amt für Standardisierung, Messwesen  
und Warenprüfung,  
Fürstenwalder Damm 388  
1162 BERLIN.

### AUSTRALIE

Mr T.J. PETRY  
Executive Director  
National Standards Commission,  
P.O. Box 282  
NORTH RYDE, N.S.W. 2113.

### AUTRICHE

Mr F. ROTTER  
Président,  
Bundesamt für Eich- und Vermessungswesen  
Arltgasse 35  
A-1163 WIEN.

### BELGIQUE

Madame M.L. HENRION  
Inspecteur Général  
Service de la Métrologie  
24-26, rue J.A. De Mot  
B-1040 Bruxelles

### BULGARIE

Mr P. ZLATAREV  
Directeur Général du Centre National  
de Métrologie  
Comité d'Etat pour la Science et le  
Progrès Technique  
Département à la Normalisation  
21, rue du 6 Septembre  
1000 SOFIA

### CAMEROUN

Mr E. NDOUGOU  
Directeur du Service des Poids et Mesures  
Direction des Prix et des Poids et Mesures  
Boîte postale 493  
DOUALA.

### CANADA

Mr R. KNAPP  
Director, Legal Metrology Branch  
Consumer and Corporate Affairs  
Tunney's Pasture  
Standards Building  
Ottawa, Ontario K1A 0C9

### CHYPRE

Mr M. EROTKRITOS  
Chief Industrial Officer  
Ministry of Commerce and Industry  
NICOSIA.

### REPUBLIQUE DE COREE

Mr KIM Sung-Hwan  
Chef de la Division Métrologie  
Bureau des Services d'Extension  
Bureau du Développement Industriel  
Ministère du Commerce et de l'Industrie  
SEOUL

**REPUBLIQUE POP. DEM. DE COREE**

Mr HO SU GYONG  
Director, Central Metrological Institute,  
Metrological Committee  
Committee of the Science and Technology  
of the State of the D.P.R. of Korea  
Sosong guyok Ryonmod dong  
PYONGYANG.

**CUBA**

Monsieur J. OCEGUERA  
C/o Mr SERRA ALMER  
Comité Estatal de Normalizacion  
Egido 610  
Zona Postal 1  
Ciudad de LA HABANA.

**DANEMARK**

Mr E. REPSTORFF HOLTVEG  
Directeur, Justervaesenet  
Amager Boulevard 115  
DK 2300 KØBENHAVN S.

**EGYPTE**

Mr F.A. SOBHY  
Président,  
Egyptian Organization for standardization  
and quality control  
2 Latin America Street, Garden City  
CAIRO.

**ESPAGNE**

Membre à désigner par son Gouvernement  
Correspondance adressée à  
Comision nacional de Metrologia y Metrotecnia  
3 calle del General Ibanez Ibero  
MADRID-3.

**ETATS-UNIS D'AMERIQUE**

Mr D.E. EDGERLY  
Manager, International Legal Metrology Program  
Office of Product Standards Policy  
Bldg. 221, room A 353  
National Bureau of Standards  
WASHINGTON D.C. 20234

**ETHIOPIE**

Mr NEGUSSIE ABEBE  
Metrologist and Head of Weights  
and Measures Inspection Section  
Ethiopian Standards Institution,  
P.O. Box 2310  
ADDIS ABABA.

**FINLANDE**

Madame U. LÄHTEENMÄKI  
Director of the Metrology Department  
Technical Inspectorate  
Box 204  
SF 00181 HELSINKI 18.

**FRANCE**

Mr P. AUBERT  
Chef du Service des Instruments de Mesure  
Ministère de la Recherche et de l'Industrie  
2, Rue Jules-César  
75012 PARIS.

**GRECE**

Madame M. GITZENI  
Fonctionnaire technique  
de la Direction des Poids et Mesures  
Direction Générale Technique  
Ministère du Commerce  
ATHENES

**GUINEE**

Mr B. CONDE  
Directeur du Service National  
de Métrologie Légale,  
Ministère du Commerce Intérieur  
CONAKRY.

**HONGRIE**

Mr M. GACSI  
Président, Országos Mérésügyi Hivatal,  
P.O. Box 19  
H-1531 BUDAPEST

**INDE**

Mr S. CHANDRASEKHARAN  
Director (Weights & Measures)  
Ministry of Civil Supplies  
Room No. 306, B-Wing,  
Shastri Bhavan  
NEW DELHI 110 001

**INDONESIE**

Mr R. HAROEN  
Direktur Metrologi,  
Departemen Perdagangan, dan Koperasi  
Jalan Pasteur 27  
BANDUNG.

**IRLANDE**

Mr M. FAHY  
Principal Officer,  
Department of Trade, Commerce and Tourism  
Frederik Building, Setanta Centre,  
South Frederik Street  
DUBLIN 2.

**ISRAEL**

Mr A. RONEN  
Controller of Weights, Measures and Standards  
Ministry of Industry and Trade  
P.O.B. 299  
JERUSALEM 94190.

**ITALIE**

Mr C. AMODEO  
Capo dell'Ufficio Centrale Metrico,  
Via Antonio Bosio, 15  
00161 ROMA.

**JAPON**

Mr M. KAWATA  
Director General  
National Research Laboratory of Metrology  
1-4, 1-Chome, Umezono, Sakura-Mura, Niihari-Gun  
IBARAKI 305.

**LIBAN**

Mr M. HEDARI  
Chef du Service des Poids et Mesures,  
Ministère de l'Economie et du Commerce,  
Rue Al-Sourati, imm. Assaf  
RAS-BEYROUTH.

**MAROC**

Mr M. BENKIRANE  
Chef de la Division de la Métrologie Légale  
Direction du Commerce Intérieur,  
Ministère du Commerce et de l'Industrie.  
RABAT.

**MONACO**

Mr A. VATRICAN  
Secrétaire Général,  
Centre Scientifique de Monaco  
16, Boulevard de Suisse  
MC MONTE CARLO.

**NORVEGE**

Mr K. BIRKELAND  
Directeur, Det norske justervesen  
Postbox 6832 ST. Olavs Plass  
OSLO 1.

**PAKISTAN**

Membre à désigner par son Gouvernement  
Correspondance adressée à  
Pakistan Standards Institution  
39-Garden Road, Saddar  
KARACHI-3.

**PAYS-BAS**

Mr A.C. BIJLOO  
Directeur,  
Dienst van het IJkwezen, Hoofddirectie  
Schoemakerstraat 97, Delft. — Postbus 654  
2600 AR DELFT.

**POLOGNE**

Mr T. PODGORSKI  
Président Adjoint,  
Polski Komitet Normalizacji, Miar i Jakosci  
ul. Elektoralna 2  
00-139 WARSZAWA.

**ROUMANIE**

Mr I. ISCRULESCU  
Directeur, Institutul National de Metrologie,  
Sos Vitan-Birzesti nr. 11  
BUCAREST 4.

**ROYAUME-UNI DE GRANDE-BRETAGNE  
ET D'IRLANDE DU NORD**

Mr G. SOUCH  
Director,  
National Weights and Measures Laboratory,  
Department of Trade  
26, Chapter Street  
LONDON SW1P 4NS.

**REPUBLIQUE DEM. SOCIALISTE DE SRI LANKA**

Mr H.L.K. GOONETILLEKE  
Deputy Commissioner  
Measurement Standards and Services Division,  
Department of Internal Trade,  
Park Road  
COLOMBO 5.

**SUEDE**

Mr R. OHLON  
Ingénieur en Chef, Statens Provningsanstalt,  
P.O. BOX 857  
S-501 15 BORAS.

**SUISSE**

Mr A. PERLSTAIN  
Directeur, Office Fédéral de Métrologie,  
Lindenweg 50  
3084 WABERN/BE.

**REPUBLIQUE UNIE DE TANZANIE**

Mr M. KABALO  
Principal Inspector, Weights & Measures  
National Bureau of Standards  
P.O. Box 313  
DAR ES SALAAM.

**TCHECOSLOVAQUIE**

Mr T. HILL  
Président, Urad pro normalizaci a mereni,  
Václavské náměstí c.19  
113 47 PRAHA 1 — NOVE MESTO.

**TUNISIE**

Mr F. MERDASSI  
Directeur des Entreprises Publiques  
Industrielles et de la Planification  
Ministère de l'Economie Nationale  
1, rue d'Irak  
TUNIS.

**U.R.S.S.**

Mr L.K. ISSAEV  
Chef du Département de Métrologie,  
Gosstandart,  
Leninsky Prospect 9  
117049 MOSCOU.

**VENEZUELA**

Mr A. PEREZ GUANCHEZ  
Directeur,  
Servicio Nacional de Metrologia Legal  
Ministerio de Fomento,  
Av. Javier Ustariz, Edif. Parque Residencial  
Urb. San Bernardino  
CARACAS.

**YUGOSLAVIE**

Mr N. BEVK  
Ingénieur, Sous-Directeur,  
Bureau Fédéral des Mesures et Métaux Précieux  
Mike Alasa 14  
11000 BEOGRAD.

## **PRESIDENCE**

Président ..... K. BIRKELAND, Norvège  
1er Vice-Président ... L.K. ISSAEV, U.R.S.S.  
2e Vice-Président .....

## **CONSEIL DE LA PRESIDENCE**

K. BIRKELAND, Norvège, Président	L.K. ISSAEV, U.R.S.S., V/Président
W. MUHE, Rép. Féd. d'Allemagne	H.W. LIERS, Rép. Dém. Allemande
D.E. EDGERLY, Etats-Unis d'Amérique	P. AUBERT, France
G. SOUCH, Royaume-Uni	H.L.K. GOONETILLEKE, Sri Lanka
A. PERLSTAIN, Suisse	

Le Directeur du Bureau International de Métrologie Légale

## **BUREAU INTERNATIONAL DE METROLOGIE LEGALE**

Directeur	B. ATHANE
Adjoint au Directeur	S.A. THULIN
Adjoint au Directeur	F. PETIK
Ingénieur Consultant	A.B. TURSKI
Administrateur	Ph. LECLERCQ

## **MEMBRES D'HONNEUR (\*)**

J. STULLA-GOTZ, Autriche — Président du Comité  
H. KONIG, Suisse — Vice-Président du Comité  
H. MOSER, Rép. Féd. d'Allemagne — Membre du Conseil de la Présidence  
F. VIAUD, France — Membre du Conseil de la Présidence  
M.D.V. COSTAMAGNA — Premier Directeur du Bureau  
V. ERMAKOV, U.R.S.S. — Vice-Président du Comité  
A.J. van MALE, Pays-Bas — Président du Comité

(\*) Note : Cette liste ne comprend pas les Membres d'Honneur décédés.

Grande Imprimerie de Troyes, 130, rue Général-de-Gaulle, 10000 TROYES  
Dépôt légal n° 6677 - Décembre 1982





